

3M Science.
Applied to Life.™

3M Personal Safety Division

European Product
Catalogue 2019/2020.



3M is an innovative, global science-based company that is focused on developing products that improve people's lives in a multitude of ways. 3M technologies developed can be found all around you. From in your home and office to in hospitals, doctor and dentist offices, your computer, your car and even in your phone, 3M helps people and business in hundreds of ways every day. Our inventions can be found in the roads, trains, and airplanes.

Our company is centered around a culture of innovation. We foster an atmosphere that provides our employees the freedom to create, the responsibility to deliver and the opportunity to connect ideas and technologies in unexpected ways. From concept to creation, we manufacture our products to exacting quality standards, while looking after our people, our communities and our planet.

Founded in 1902, we have a proud history as a company that strives to be ethical and innovative. From science that works behind the scenes in products you use every day and technology embedded in processes that help industries thrive to tangible products we use every day, the science provided by 3M can be found in many aspects of our lives.

We live our motto every day.
3M. Science. Applied to life.

Contents

About 3M

A culture of innovation	Pages	4-6
Giving back	Page	7

3M Personal Safety Division

Training and education	Pages	8
The 3M Worker Health and Safety Academy	Pages	9
Services	Pages	10-11
Science of Safety	Pages	12-13
Productivity	Page	14

Respiratory Protection

Filtering Facepiece Respirators	Pages	19-30
Reusable Respirators	Pages	31-50
Powered and Supplied Air Respirators	Pages	51-80

Hearing Solutions

Hearing Protection	Pages	85-94
Communication Solutions	Pages	95-106

Head, Eye and Face Protection

Integrated Head and Face Protection	Pages	109-120
Protective Eyewear Solutions	Pages	121-144
3M™ Scott™ Fire & Safety Solutions	Pages	145-148
Welding Protection	Pages	149-162

Body Protection

Protective Apparel	Pages	165-182
3M™ Scotchlite™ Reflective Materials	Pages	183-190

Fall Protection

Pages 191-236

About 3M

A culture of innovation

We act differently because we embrace a culture that encourages us to think differently. It's what pushes us forward and ensures that we stay at the forefront of scientific technology.

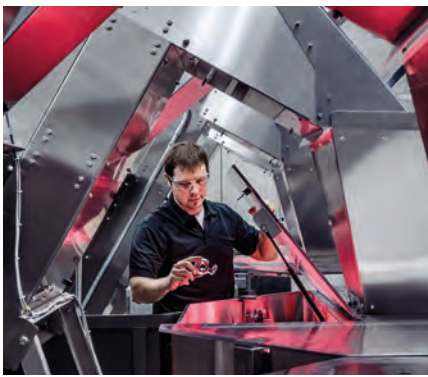

Investing in innovation

As a world leading innovation company we are constantly looking for new ways to support our customers. Over the past five years we have invested \$8.5 billion (approximately six per cent of our global revenue) back into research and development. One third of our sales come from products that didn't exist five years ago - testament to the strength of our innovation.

The McKnight Principles

No one shaped 3M's culture more than William McKnight, who was hired in 1907 as a bookkeeper and eventually become president and chairman.

He left a legacy called the "McKnight Principles," which boil down to this: "Hire good people and leave them alone."

Creative freedom

It was McKnight who, more than six decades ago, encouraged 3Mers to spend 15 percent of their time exploring their own ideas and projects.

Our 15 percent culture is alive and well today, and has led to some of our most ingenious inventions. This helps maintain an enthusiasm to find new solutions to the challenges facing our customers.

This culture is what lies behind thousands of products that 3M have introduced over the years.

About 3M

51 technology platforms

Our 51 core technology platforms, ranging from adhesives and abrasives to sensors and electronics materials, drive innovation across our business. Individual business groups draw upon these core technologies to develop products for targeted markets.

Connected thinking

A spirit of collaboration underpins everything we do. As a community of innovators, we are constantly connecting people with knowledge and experience from different fields to answer our customers' challenges. At the same time our 46 technology platforms allow us to apply science from one area to advance another. From unexpected market applications, to the limitless possibilities of merging different technologies.

Connecting people and ideas

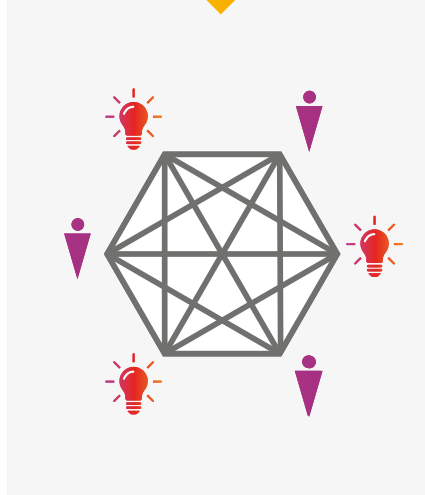

Applying technologies across different markets

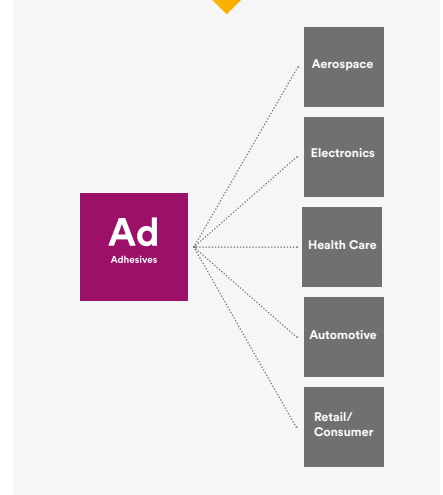

Blending technologies

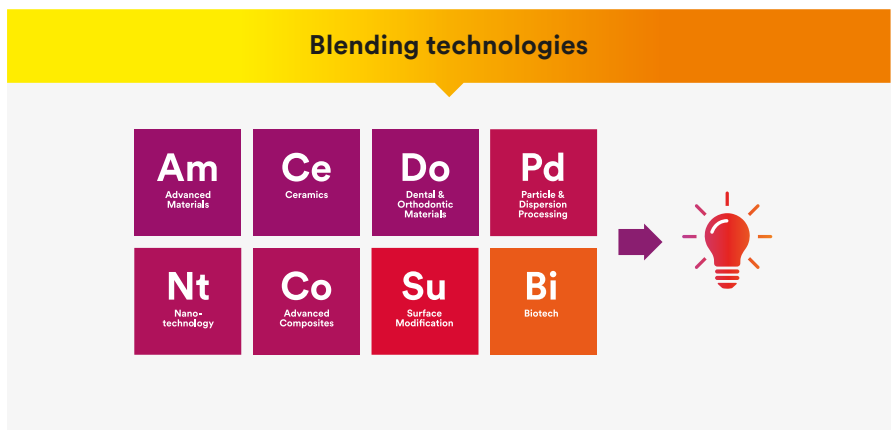

Ab Abrasives													
Ad Adhesives	Em Electronic Materials											Di Display Components	Hd Healthcare Data Management
Bi Biomaterials	Fi Films	Nw Nonwovens								Ms Modeling & Simulation	Ac Acoustic Management	Ec Energy Components	Lm Light Management
Ce Ceramics	Fl Fluoro-materials	Pm Performance Materials	Am Additive Manufacturing	Pc Precision Coating & Web Processing	Rp Radiation Processing	An Analytical Science	Pr Process Design & Control	Cv Computer Vision	Ro Advanced Robotics	Bd Biodetection & Microbial Management	Eg Engineered Graphics	Mf Mechanical Fasteners	
Co Advanced Composites	Mm Metamaterials	Po Porous Materials & Membranes	Mo Molding	Pd Particle & Dispersion Processing	Su Surface Modification	Cp Converting & Packaging	Sd Sustainable Design	Ds Data Science & Analytics	Se Sensors	Cs Connected Systems	Fe Flexible Electronics	Sw Skin & Wound Management	
Do Dental & Orthodontic Materials	Nt Nano-technology	Rm Release Materials	Mr Micro-replication	Pp Polymer Processing	Tf Thin Film & Plasma Processing	In Inspection & Measurement	We Accelerated Weathering	Es Electronic Systems	Ss Software Solutions	Dd Drug Delivery	Fp Filtration & Purification	Tm Thermal Management	
Materials			Processing				Capabilities			Digital		Applications	

An aerial photograph of a wide, multi-lane city street, likely in Stockholm, Sweden. The street is flanked by dense, lush green trees. In the background, a city skyline is visible under a clear blue sky. The lighting suggests a bright, sunny day.

“3M harnesses the power of science to make the world safer, more efficient and more prosperous. We use our science to solve challenges with our customers, and to stretch toward our vision of advancing every company, enhancing every home and improving every life.”

Inge G. Thulin Chairman of the Board, President and Chief Executive Officer

About 3M

Giving back

When it comes to sustainability, we'd consider our society to be just as important as the environment. We have, over time, invested over \$1.4 billion in creating sustainable communities. Under our 3M4Good scheme, our employees are entitled and encouraged to spend one day a year on volunteer work, some of our colleagues have gone out into communities to help with projects such as gardening and the construction of buildings, both in Europe and further afield. In addition to this our legal teams are recognised for their pro-bono work, with seniors, immigrants and children. This is in addition to our regular fundraising activities for local and larger charities, including a yearly 10km fun run by our UK Aycliffe lab.



Investing in young minds

Not only do we think that society is an important part of sustainability, but for continued development, we also believe in investing in the education of young people. This is why we have done a lot of work in STEM education, reinforcing the wonders of science with our visiting wizards who go into schools and perform experiments. We also have formed a partnership with Discovery Education in order to set up the Young Scientist Challenge.



World skills

3M are an official Global Industry Sponsor of World Skills. They provide training and work to increase skills amongst young people worldwide which will help them grow and in turn enable them to form a strong and skilled work force. This organisation is very important to us. Educating both young and old, teaching them new skills is and will continue to be an essential process. Because as the world we live in changes, we will have to change with it.



3M Personal Safety Division

Training and education

Training tailored to you

At 3M we believe that education is key to protection. It is essential that workers and safety managers understand the risks to their health in the workplace and know how to protect against these risks in the best way. In order for them to do this, we provide a vast array of training, suited to different businesses and individual needs.



On-site and on topic

We can provide on-site training, with a visit from our Safety Caravan, mobile across the EU or with the SafeTea Break concept recently introduced in the UK, which aims to give safety managers the chance to teach workers about health and safety issues and the importance of wearing PPE. We also provide extensive training to distributors, so that they can then advise and assist customers in selecting the correct protective equipment for their workplace. Of course our technical service teams are also on hand to present their expert knowledge of the Health and Safety Industry.



Accessible to all

We work hard to make sure that our training and tools are accessible to all, which is why we have developed an extensive eAcademy. We currently have modules spanning how the different parts of the body work, different hazards in the workplace, and how it is possible to protect against them. We are determined to increase the safety culture and having online training means we can reach more people. It is also flexible to the learning pace of the user, and very user friendly as well as being convenient and relevant to the needs of each individual.



3M Personal Safety Division

The 3M Worker Health and Safety Academy

The flexible way to discover and learn throughout your busy day

Join us online any time of the day to expand your knowledge on our current range of personal protective equipment for the workplace. Learn what you want, when you want, where you want... and at a pace that's right for you.



3M offers you engaging interactive training on topics relevant to you

- Workplace hazards and health effects
- Industry standards and regulations
- The approach to protection
- 3M Personal Safety Solutions

Why e-learning?

Conventional training can often be difficult to manage. It can also be expensive, not simply in monetary terms, but in the time that people are kept away from their job. Time may be limited to cover content, whilst finding a convenient time for both trainer and staff may also be difficult.

- User-friendly site with online help
- Convenient – learn whenever and wherever you want
- Flexible – learn at a pace that's comfortable
- Personalised completion certificates
- Structured curriculum deployed training
- Managers customised employee training reports

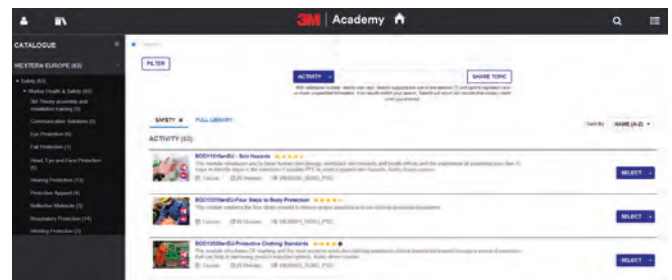

3M Personal Safety Division

Services

We believe that with a quality product, it is important that the customer also receives quality services. Not only do we provide different varieties of training and education, but we also have many other tools available to our customers.

Fit testing is key

In order to be fully protected, it is essential that PPE fits correctly. We provide fit testing for respirators (and fit testing guidelines online) as well as E-A-Rfit Validation testing for earplugs and earmuffs. We know that everyone is different and in order to get the best protection it is crucial that they know how to correctly fit and wear their personal protective equipment.

3M™ Respiratory Fit Testing System

3M Respiratory Protection offers a wide range of disposable and reusable respirators, as well as Powered and Supplied Air Respiratory Systems. However, even high quality products need a secure fit in order to protect the wearer. One model of respirator may not fit everyone. When choosing a respirator users should be fit tested in accordance with national requirements. For information on fit testing procedures, contact your safety officer or 3M. Even after a user has had a fit test, a fit check should be carried out before each use. A Respiratory Fit Check guide is available on **page 23** of this catalogue.



3M™ E-A-Rfit Dual-Ear Validation System

As the leader in hearing protection, 3M offers a complete solution, with dual-ear and earmuff testing capabilities plus a user-friendly interface. The 3M™ E-A-Rfit Dual-Ear Validation System is the fast and easy way to find your employees' PAR, because we know how important it is to make your hearing conservation program fit seamlessly into your operation.

Get results you can trust. The 3M™ E-A-Rfit Dual-Ear Validation System measure the effectiveness of the earplug or earmuff inside the employee's ear providing accurate, quantitative results. Because you can simultaneously test both ears, you have more to focus on education including the importance of fit and protection.



3M™ Eyewear Fit System

When it comes to eyewear, a comfortable, well-fitted workforce is likely to be more effective. Current standards suggest careful consideration should be given to eyewear fit, however there is no specific guidance on how to evaluate eyewear fit on an individual. In view of this, 3M have developed the Eyewear Fit System, a simple 6 step method, designed to help select the best fitting eyewear for an individual.

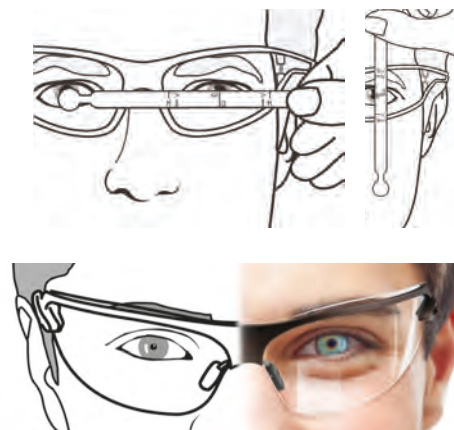

Find out more by contacting your 3M Personal Safety Sales Representative.

3M Personal Safety Division

3M Online

A selection of downloadable and printable documents are available online, such as selection tools, fit test guides, and guidance on the importance of protection. From our website you will be able to access product information, with market area specifications, to help select the right personal protective equipment for the right environment. You will also be able to discover webinars by experts concerning health and safety in the workplace as well as our own eAcademy.

Everything in one place, on your computer, laptop, tablet or mobile.

- Access our news, or eAcademy, find out where to buy or how to contact us
- Quick links to our Product Catalogue
- Quick product search
- Narrow your selection
- Tailored Solutions for your industry
- Compare Products
- Our catalogue on your mobile
- Subscribe to our newsletter
- Download product and technical documents

3M PPE Safety Solutions

Subscribe to our channel on YouTube to watch customer testimonials, technical support or product information videos.

Visit www.youtube.com/user/3MPPESafetySolutions

You can also:

Find us on Facebook  or Follow us on Twitter 

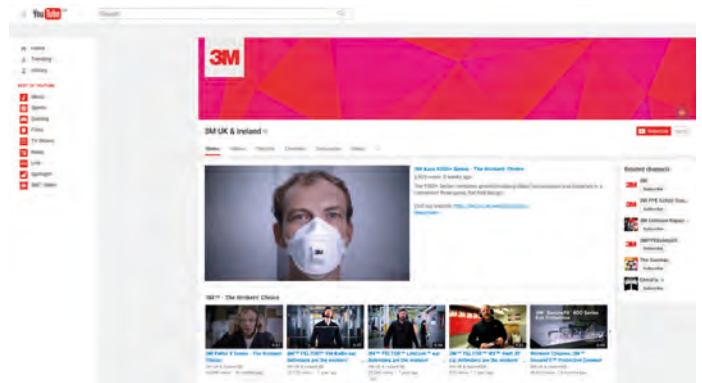

3M Personal Safety Division

Science of Safety

3M's new Science of Safety approach can support you with guidance on:



Selection



Training



Fit validation

3M delivers consistent quality around the world helping you select the correct PPE for your workers, helping to ensure your workers are educated on the correct use of PPE and raising awareness of how important fit and comfort are to the health and wellbeing of your workforce.

For more information visit www.3M.eu/SoS



Source: HSE Research Report RR720 'Real world use and performance of hearing protection'

H&S officials

and employers have a duty to provide the correct safety equipment and training.

Maintaining consistency in this arena can prove difficult, hindering the health and safety process.



Many companies don't have the ability to test whether PPE fits the employee properly.



Employees are at risk of damaging their health long term which may lead to an increase in liability for employers.

3M Personal Safety Division



Why partner with 3M for your health and safety?

3M can deliver consistent quality around the world



Our industry-leading approach embraces best practice on a global level



Selection



Training



Fit validation



3M PPE equipment

industry-leading breadth and depth, helping to optimise protection and fit.



3M can give local support and advice wherever you do business

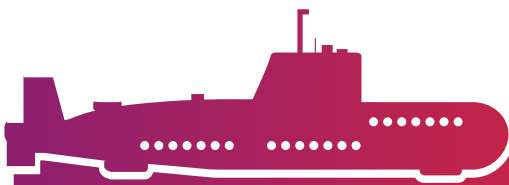

www.3M.eu/SoS

#3MScienceOfSafety

3M Personal Safety Division

Productivity

We don't only aim to improve the safety of our customers, we also want to help them keep costs down. Our products are designed to last and to provide more efficient protection, but they can bring efficiencies in other ways.

PELTOR™

As many supervisors know, efficient on-site communication can save a lot of time throughout the duration of a project. Recently, a study by Lund University Faculty of Engineering in Sweden showed that downtime and interruptions were reduced by 19% when two-way radio communication headsets were used. A single construction worker gained 380 minutes of productive time per week.

The study was conducted by Victoria Joang and Aidin Sakikovic, two researchers from Lund's graduate program in civil engineering. They compared two work weeks on one of Skanska's major water main projects in Sweden, analysing similar work activities during each week. In the first week, the workers did not use two-way radios. In the second week, they were equipped with 3M™ PELTOR™ WS™ LiteCom Headsets, which have a built-in two-way radio and a Bluetooth® wireless technology mobile phone connection.

Detailed follow-up interviews showed that the big advantage was being able to quickly relay and receive messages on the job, especially on large construction sites where eye contact is not possible. Improved team spirit was another reported benefit.

Speedglas™

Another example of efficiency can be seen in our Welding portfolio, where, by using a 3M™ Speedglas™ Welding Helmet with auto-darkening filters, companies can save up to 1€ per hour.

We have created a Return on Investment calculator for the welding portfolio, where you can input all your numbers to see how much your company would save by using these auto-darkening filters. From this we have calculated that a company with low salary costs who have previously not used an auto-darkening filter, would be able to save 75 euro cents per hour per worker by using almost any auto-darkening filter. So if they had 100 workers, all wearing an auto-darkening filter, 5 days a week, for 8 hours they would make a weekly company saving of 3000 euros.





Respiratory protection

3M™ Respiratory Protection Equipment

Types of Protection Equipment from 3M

3M offers you a wide range of disposable, reusable, powered and supplied air respirators for protection against gases, vapours and particulates allowing you to choose the level and type of protection, comfort, style and maintenance requirements you need to work safely, comfortably and effectively.

There are three main types of RPE available from 3M on the following pages:

Filtering Facepiece Respirators

- Ideal for most industries and applications where wearers require particulate protection e.g. dusts and mists
- A choice of cup-shape or flat-fold, valved or unvalved and also the option to protect against ozone and nuisance levels of organic vapours and acid gases
- Available in two types to satisfy single shift use (NR) and reusable (R) requirements
- Lightweight and maintenance free
- Comfortable, convenient and easy to use



Reusable Half and Full Face Respirators

- Offer protection against particulates, gases and vapours and combinations of the two
- These respirators have integrated or replaceable filters and parts. They may be cleaned, stored and reused provided they are in good condition
- Full face respirators also offer integrated eye and face protection
- Many models are fully maintainable



Powered Air & Supplied Air Systems

- Offer protection against dusts, mists, fumes, gases, vapours and combination hazards e.g. paint spray
- Can offer integrated eye, face, head, neck and hearing protection in one system avoiding incompatibility issues between items of PPE
- Modular system allows you to mix and match parts as your environment or application changes giving you the ultimate in flexibility and ease of use
- No increase in breathing resistance means more comfortable and longer wear time
- Usable by a wide range of users regardless of facial characteristics; shape, size etc.



3M™ Respiratory Protection Equipment

The 4-Step Method

Selecting and specifying the appropriate respiratory protective equipment may appear daunting with so many factors to consider and so many options to choose from. With our simple 4-step method it's easy to choose the correct level of protection and comfort required to optimise respiratory protection:

1. Identify the hazards

Respiratory: dust, metal fume, gas, vapour etc.
Other neck-up: head, eye, face, hearing etc.



2. Assess the risk

Assess the hazard levels against safety standards and consider other protection e.g. skin, eye, face, head and body



3M™ Organic Vapour Monitor Badges measure personal exposure to hazards

3. Select the right respirator

Disposable, reusable, half mask, full face, powered air, supplied air and the right filter if appropriate



4. Train in fitting and use

Make sure you know how to use and maintain your RPE to ensure effective respiratory protection. 3M sales and technical professionals can help you to define your training needs and can provide training and on-site consultations on all aspects of respiratory protection tailored to your individual needs. You'll also find easy to use training on our website:

www.3M.eu/PPESafety







Filtering Facepiece Respirators

Comfortably breathing clean, safe air is important for workers' health and workplace morale. With this in mind we have designed a range of 3M™ Filtering Facepiece Respirators using science to increase comfort, breathability and protection.

In combination with ergonomic design, a wide range of technologies including the new 3M™ Cool Flow™ Comfort Valve help to deliver comfortable protection with easier breathing and reduced heat build-up.

3M™ Filtering Facepiece Respirators

The 4-Step Method

1. Identify the Hazards

Application		Suggested Minimum Performance Level	Important Information
Sanding, Cutting, Drilling	Rust, Metal Particles, Filler	FFP1	
	Concrete, Stone	FFP1	
	Cement, Wood, Steel	FFP2	FFP3 When Silica is present
	Paints/Varnish/Anti-rust coating	FFP2	
	Steel, Stainless Steel	FFP3	FFP3 When Chromates are present Speciality respirator may be required
	Anti-Fouling Varnish	FFP3	
Low temp. oil spray		FFP2	
Welding	Mild Steel, Zinc (Autogen, MIG/MIK)	FFP2	3M™ 9928 or 3M™ 9925 for Ozone protection FFP3 May be required in some countries - see national regulations
	Stainless Steel (Electrodes)	FFP2	3M™ 9928 or 3M™ 9925 for Ozone protection FFP3 May be required in some countries - see national regulations
	Soldering	FFP2	FFP3 May be required in some countries - see national regulations
Work with Asbestos	Small amounts infrequent exposure	FFP3	
Work with Glass and Mineral fibres		FFP2	
Waste Sorting		FFP2	Speciality Respirator may be preferred May need gas and vapour respirator
Spraying	Paint spray	FFP2	May need gas & vapour respirator
	Pesticides (water based)	FFP2	
Utility maintenance (e.g. filter change)		FFP3	
Allergies	Pollen, Animal dander	FFP1	
	Grain dust	FFP2	
Contact with:	Mold/Fungus	FFP2	FFP3 With Tuberculosis or high consequence infectious microorganisms
	Bacteria/Virus	FFP2	
	Diesel exhaust/Smoke	FFP2	

Warning: This guide is only an outline. It should not be used as the only means for selecting a respirator. Details regarding performance and limitations are set out on the respirator package and user instructions. Before using any of these respirators, the wearer must read and understand the user instructions for each product. Specific country legislation must be observed. Please note that the applications shown highlight some of the hazards which may be considered. Selection of the most appropriate respiratory protective equipment (RPE) will depend on the particular situation and should be made only by a competent person knowledgeable of the actual working conditions and the limitations of RPE.

2. Assess the Risk

	EN 149:2001+A1:2009 FFP1 Respirators	EN 149:2001+A1:2009 FFP2 Respirators	EN 149:2001+A1:2009 FFP3 Respirators	EN 149:2001+A1:2009 Welding Respirators
Nominal Protection Factor (NPF)	NPF 4	NPF 12	NPF 50	NPF 10
Typical Applications	Low levels of fine dust particles and oil or water based mist typically found during hand sanding, drilling and cutting	Moderate levels of fine dust particles and oil or water based mist typically found during plastering, cement, sanding and wood dust	Higher levels of fine dust particles and oil or water based mist typically found when handling hazardous powders found in the pharmaceutical industry or work with biological agents and fibres	Moderate levels of fine dust particles, oil and water based mist, metal fume and ozone and organic vapours below exposure limit typically found in welding and soldering

Nominal Protection Factor (NPF): The theoretical protection level of a respirator based on laboratory measured performance data.

3M™ Filtering Facepiece Respirators

3. Select the right respirator

Once you have selected the protection factor you require, you can then consider whether you need a cup-shaped respirator, or a foldable respirator, whether it has buckled straps and whether it is valved or not.



3M™ Cup-Shaped Respirators

- Convex shape, nose clip and twin strap design
- Easy to fit
- Durable, collapse resistant shell



3M™ Buckle Strap Respirators

- Robust and durable design provides multishift capability and secure feel
- Adjustable braided headbands
- Soft inner face-seal improves comfort



3M™ Foldable Respirators

- Ultra soft, flexible and comfortable fit resulting from the multiple panel design
- Comfort Series - Flat Fold only: Individually packed, foldable design prevents contamination before use and allows easy storage



3M™ Cool Flow™ Valve

- Effective removal of heat build-up provides a cooler and more comfortable wear
- Provides longer continuous wear time
- Reduces risk of fogging of spectacles and eyewear

4. Train in fitting and use

Training offered by 3M

Correct use and appropriate maintenance of personal protective equipment (PPE) from 3M makes a major contribution towards ensuring that it provides effective protection. Our experienced sales and technical teams will help you make the most of your products. In compact

training units, they will show you and your employees how to recognise potential hazards, suggest what measures to take and help explain how to choose the appropriate protective equipment for each particular situation.

EN 149:2001+A1:2009 Standard

3M™ Filtering Facepiece Respirators meet the requirements of European Standard EN 149:2001 + A1:2009, filtering facepiece respirators for use against solid and non-volatile liquid particles only. Products are classified by filtering efficiency and maximum total inward leakage performance (FFP1, FFP2 and FFP3), also by usability and clogging resistance.

Performance tests in this standard include:

- filter penetration and extended exposure (loading) test - evaluates the filtration performance when new and over time
- breathing resistance - evaluates the ease of breathing (inhalation and exhalation) through the respirator
- total inward leakage - evaluates the filter penetration, valve leakage (if fitted) and importantly the face seal leakage of the respirator when worn by a panel of different people whilst conducting simulated work exercises
- clogging resistance - evaluates the ability of the respirator to continue to function effectively and provide respiratory protection in very high dust environments

Reusable products are also subjected to a cleaning cycle (specified by the manufacturer) and 24 hour storage to confirm the product performance is not affected by re-use. Clogging resistance testing is a mandatory requirement for reusable products, but is optional for single shift use only (non reusable) products. A full copy of EN 149:2001+A1:2009 can be purchased from your national standards body.

Marking designations:

- R = Reusable
- NR = Non reusable (single shift use only)
- D = Meets the clogging resistance requirements

3M™ Filtering Facepiece Respirators

The importance of comfort

To make sure that the respirator protects you, it must be worn during all periods of exposure. Make sure that you choose a respirator that you can wear comfortably for your entire shift.



Face and head comfort

The respirator's edge should be flexible and the shape and size should cover the nose, mouth and chin without causing excessive pressure. A headband material which provides a good, even tension across the head can ensure a comfortable, secure fit for a range of head sizes.



Skin comfort

Skin comfort will be affected by the smoothness and softness of the inner material in contact with the skin - especially over a long period of time. A soft inner face seal and sweat absorbent nose foam will provide greater comfort. Rough or hard materials, coupled with a high temperature inside the respirator may be itchy and unpleasant.

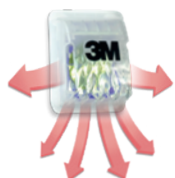

Coolness

An efficient exhalation valve minimises heat build up, particularly in hot and humid work conditions.



Lightweight

Take advantage of technological innovation and choose a lightweight respirator for optimal comfort.



Breathing ease

An efficient exhalation valve and high-efficiency, low breathing resistance filter material will help you to breathe comfortably.



Compatibility with other PPE

Make sure that the respirator you select fits well with the other PPE required for your work such as eyewear and hearing protection to ensure maximum comfort.

3M™ Filtering Facepiece Respirators

The importance of fit

Particulate respirators and reusable half face masks are most effective when there is a good seal between the edges of the respirator and your face. The instant this seal is broken, protection is compromised as contaminated air can leak in through any gaps.

Here's what to look for:

- Upper strap should be positioned on the crown of the head. Strap should not be twisted
- Respirator should be correctly positioned on your face and head
- Lower strap should be positioned below the ears. Strap should not be twisted
- Care must always be taken to ensure other safety equipment is compatible with your respirator and does not interfere with its fit, for example, straps should always be fitted underneath safety eyewear and hoods



- Before fitting your respirator, make sure that your face is clean shaven. Respirators must not be worn with stubble, beards or other facial hair under the area of the face seal as these can prevent a good seal to the face



- For flat fold respirators make sure the panels are fully unfolded
- Noseclip should be moulded around nose and cheeks to give a good seal. Using both hands, mould noseclip to the shape of the lower part of the nose to ensure a close fit and good seal. Do not pinch the noseclip with only one hand as this may not give a good fit



Fit Check

- A pre-use fit check must be conducted every time you fit your respirator
- Cover the front of the respirator with both hands, being careful not to disturb the fit of the respirator
- Unvalved respirator – exhale sharply, Valved respirator – inhale sharply
 - If air leaks around the nose, re-adjust the noseclip to eliminate leakage
 - If air leaks at the respirator edges, work the straps back along the sides of the head or adjust the tension to eliminate leakage

Repeat the above fit check.

If you cannot achieve a proper fit do not enter the hazardous area - see your supervisor.



One model of respirator may not fit everyone. Users should be fit tested in accordance with national requirements. For information on fit testing procedures, contact your safety officer or 3M.

3M™ Filtering Facepiece Respirators

Comfort Series: 3M™ Aura™ Particulate Respirators 9300+Gen3 Series

Safety and comfort are a top priority at 3M. The third generation of Aura™ respirator brings a number of improvements, combining impressive new technology with ergonomic design.

The new Cool Flow™ Comfort Valve opens easier to help reduce heat inside the respirator, delivering a more comfortable wearer experience.

Typical Applications

- Construction
- Metal working
- Agriculture
- General manufacturing
- Automotive
- Woodworking
- Maintenance
- Chemical/ petrochemical
- Pharmaceuticals/ laboratory

Features and benefits:

Convenience of use

- New upper and lower tabs
- Simplified positioning and adjustment on the face with new 'grip' feature on the valve

New 3M™ Cool Flow™ Comfort Valve

- Updated, modern and stylish design with clear cover lets you see new technology in action
- Allows more hot air out to reduce heat buildup and increase comfort
- Helps to minimise the risk of eyewear fogging from heat exiting through the media (certain models only)

Engineered for comfort

- New braided headbands for enhanced durability
- Colour coded for easy identification (yellow for FFP1, blue for FFP2, red for FFP3)
- 3-panel flat-fold design

Clear vision

- Embossed top panel helps re-direct exhaled air, reducing fogging of eyewear
- Curved, low profile design conforms well to nose and eye contours – helps provide a good field of vision
- Designed to be compatible with safety eyewear from 3M

Cooler breathing – 3M™ Advanced Electret (Filter) Media (AEM)

- High charge on filter fibres attracts particles from a wider capture area, enabling less filter media to be needed
- Low initial breathing resistance

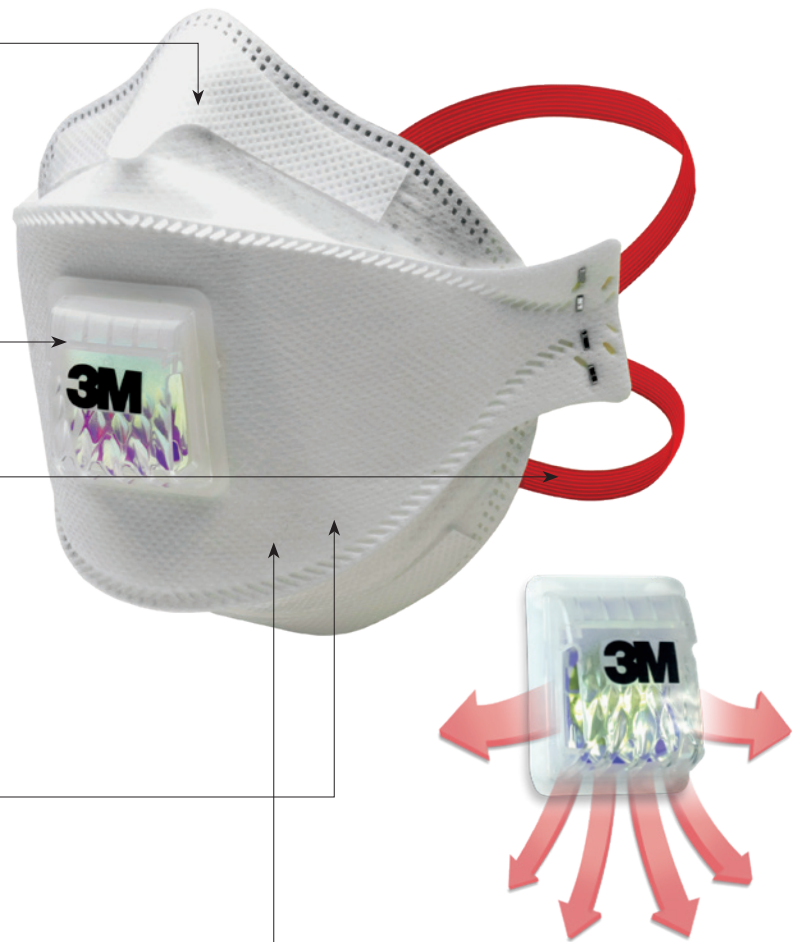

	Classification	Protection	Nominal Protection Factor	
3M™ Aura™ 9310+Gen3	EN 149:2001+A1:2009 FFP1 NR D	Dust/Mist	4	FFP1
3M™ Aura™ 9312+Gen3 (valved)	EN 149:2001+A1:2009 FFP1 NR D	Dust/Mist	4	FFP1
3M™ Aura™ 9320+Gen3	EN 149:2001+A1:2009 FFP2 NR D	Dust/Mist	12	FFP2
3M™ Aura™ 9322+Gen3 (valved)	EN 149:2001+A1:2009 FFP2 NR D	Dust/Mist	12	FFP2
3M™ Aura™ 9330+Gen3	EN 149:2001+A1:2009 FFP3 NR D	Dust/Mist	50	FFP3
3M™ Aura™ 9332+Gen3 (valved)	EN 149:2001+A1:2009 FFP3 NR D	Dust/Mist	50	FFP3

3M™ Filtering Facepiece Respirators

3M™ Particulate Cup Shaped Respirator 8825+ and 8835+

The 3M™ Cup Shaped Respirators 8825+ and 8835+ have been engineered to help improve fit to wearer's individual face shape and size. With their robust shell and cup design, these respirators meet the particular requirements of the clogging test for FFP (filtering face piece) respirators and are EN 149 'R' rated which means that they may be used for more than one shift.

Features and benefits:

Proprietary soft inner face seal

- Flexible material helps form comfortably onto a wide range of face shapes and sizes
- Innovative contoured design engineered to help provide a more secure seal around the nose
- Comfortable feel on the skin
- Easy to clean for wearer hygiene using the 3M™ Face Seal Cleaning Wipe 105 (as per EN 149+A1)
- Designed to help reduce eyewear fogging

Innovative design

- Engineered to help improve fit to wearer's individual face shape and size
- EN 149 'R' Rated. Reusable – this mask can be used for more than one shift
- Collapse resistant: works well in hot humid environments
- Modern and stylish
- Easy to don and doff

3M™ Advanced Electret Filter Media (AEM)

- High performance filter material that's easy to breathe through
- Meets the clogging test requirements of EN 149:2001+A1:2009
- Consistent high quality performance

3M™ Cool Flow™ Valve

- Effective exit of heat build up provides a cooler and more comfortable wear and helps to minimise the risk of fogging eyewear

Adjustable braided headbands

- 4-point adjustment helps to provide a more secure feel
- Comfortable on the head and neck

Materials

This product does not contain components made from:

- natural rubber latex
- metal
- PVC



	Classification	Protection	Nominal Protection Factor	
3M™ Particulate Respirator 8825+	EN 149:2001+A1:2009 FFP2 NR D	Dust / Mist / Metal Fume	12	FFP2
3M™ Particulate Respirator 8835+	EN 149:2001+A1:2009 FFP3 NR D	Dust / Mist / Metal Fume	50	FFP3

3M™ Filtering Facepiece Respirators

Comfort Series: 3M™ Aura™ Flat Fold 9300+ Series

Features and benefits:

Embossed top panel

- Helps reduce fogging of eyewear

Foldable – proprietary 3-panel design

- Ingenious 3-panel design fits a wide range of face shapes and sizes
- Collapse resistant: ideal for work in hot humid environments

Sculpted nose panel

- Curved, low profile design
- Conforms well to nose and eye contours
- Helps provide a good field of vision and improves compatibility with eyewear

Low breathing resistance filter technology

- Combines the benefits of 3M's electret particulate filter material with advanced low breathing resistance filter technology

3M™ Cool Flow™ Valve

- Effective removal of heat build up provides a cooler and more comfortable wear
- Removes exhaled air and minimises the risk of fogging eyewear

Chin tab

- Improves ease of donning and adjustment to help achieve a comfortable fit



	Classification	Protection	Nominal Protection Factor	
3M™ Aura™ Particulate Respirator 9310+	EN 149:2001+A1:2009 FFP1 NR D	Dust/Mist	4	FFP1
3M™ Aura™ Particulate Respirator 9312+ (valved)	EN 149:2001+A1:2009 FFP1 NR D	Dust/Mist	4	FFP1
3M™ Aura™ Particulate Respirator 9320+	EN 149:2001+A1:2009 FFP2 NR D	Dust/Mist	12	FFP2
3M™ Aura™ Particulate Respirator 9322+ (valved)	EN 149:2001+A1:2009 FFP2 NR D	Dust/Mist	12	FFP2
3M™ Aura™ Particulate Respirator 9330+	EN 149:2001+A1:2009 FFP3 NR D	Dust/Mist	50	FFP3
3M™ Aura™ Particulate Respirator 9332+ (valved)	EN 149:2001+A1:2009 FFP3 NR D	Dust/Mist	50	FFP3

3M™ VFlex™ Flat Fold 9100 Series

Features and benefits:

Adjustable noseclip

- Helps provide a custom and secure seal
- Imbedded, metal detectable

Tabs

- Designed for positioning the respirator on the face

Embossed front panel

- Helps the respirator retain its shape, away from your mouth
- Helps maintain spacious feel

3M™ Cool Flow™ Valve

- Increased comfort and breathability thanks to 3M™ Cool Flow™ valve

V-shaped pleats

- Flex and expand with mouth movement for easier talking and breathing

Comfortable inner Layer 3M™ Proprietary Media

- 3M™ high performance filter material provides effective filtration combined with low breathing resistance

Flat-fold convenience

- Convenient storage prior to use

Additional design features

- Elastic headbands contain no natural rubber latex components
- Spacious feel inside, with minimal impact on field of vision
- Compatible with a variety of eyewear and hearing protection from 3M™
- Available in 2 sizes
- Fits a broad range of faces



	Classification	Protection	Nominal Protection Factor	
3M™ VFlex™ Particulate Respirator 9101E	EN 149:2001+A1:2009 FFP1 NR D	Dust/Mist	4	FFP1
3M™ VFlex™ Particulate Respirator 9101ES (Small size)	EN 149:2001+A1:2009 FFP1 NR D	Dust/Mist	4	FFP1
3M™ VFlex™ Particulate Respirator 9152E	EN 149:2001+A1:2009 FFP2 NR D	Dust/Mist	12	FFP2
3M™ VFlex™ Particulate Respirator 9152ES (Small size)	EN 149:2001+A1:2009 FFP2 NR D	Dust/Mist	12	FFP2
3M™ VFlex™ Particulate Respirator 9161E	EN 149:2001+A1:2009 FFP1 NR D	Dust/Mist	4	FFP1
3M™ VFlex™ Particulate Respirator 9161ES (Small size)	EN 149:2001+A1:2009 FFP1 NR D	Dust/Mist	4	FFP1
3M™ VFlex™ Particulate Respirator 9162E	EN 149:2001+A1:2009 FFP2 NR D	Dust/Mist	12	FFP2
3M™ VFlex™ Particulate Respirator 9162ES (Small size)	EN 149:2001+A1:2009 FFP2 NR D	Dust/Mist	12	FFP2
3M™ VFlex™ Particulate Respirator 9163E	EN 149:2001+A1:2009 FFP3 NR D	Dust/Mist	50	FFP3
3M™ VFlex™ Particulate Respirator 9163ES (Small size)	EN 149:2001+A1:2009 FFP3 NR D	Dust/Mist	50	FFP3



3M™ Filtering Facepiece Respirators

Comfort Series: 3M™ Cup Shaped 8300 Series

The 3M™ 8300 Series Respirators enable you to enjoy a comfortable 'cushion-fit', facing hard work from a soft place. The super-soft, cushioned lining provides instant yet lasting comfort; whilst the robust design makes the 8300 Series tough and durable – all this helps to increase user wearability.

Features and benefits:

Braided headbands

- Materials have been selected for extra comfort and durability
- Colour-coded headbands offer easy protection level identification

M-Noseclip

- The noseclip is quick and easy for wearers to mould around the nose offering greater comfort

Robust outer shell

- The shell construction offers users added durability

3M™ Cool Flow™ Valve

- The Cool Flow valve reduces heat build-up to offer workers comfortable protection – even in hot humid conditions

3M™ High Performance Filter Material

- Effective filtration helps wearers to breathe easily through the respirator for more comfortable protection

'Cushion-fit' lining

- The super-soft, cushioned inner lining helps workers stay comfortable

Soft waffle edge

- The flexible, textured edge offers a comfortable and secure feel on the face

Soft inner face seal (8833 only)

- Gives a secure, conforming fit for added comfort
- Can be cleaned for wearer hygiene if used for longer than one shift



	Classification	Protection	Nominal Protection Factor
3M™ Particulate Respirator 8310	EN 149:2001+A1:2009 FFP1 NR D	Dust / Mist	4 FFP1
3M™ Particulate Respirator 8312 Valved	EN 149:2001+A1:2009 FFP1 NR D	Dust / Mist	4 FFP1
3M™ Particulate Respirator 8320	EN 149:2001+A1:2009 FFP2 NR D	Dust / Mist	12 FFP2
3M™ Particulate Respirator 8322 Valved	EN 149:2001+A1:2009 FFP2 NR D	Dust / Mist	12 FFP2
3M™ Particulate Respirator 8833 Valved	EN 149:2001+A1:2009 FFP3 NR D	Dust / Mist	50 FFP3

Classic Series: 3M™ Cup Shaped 8000 Series

The 3M™ Respirators 8000 Series provide lightweight, comfortable and effective respiratory protection against dust and mist. The convex shape, twin strap design, nose foam and nose clip ensure comfortable wear over a range of face sizes. The collapse resistant shell and 3M™ Cool Flow™ Valve in the 8822 and 8812 respirators offer durable, comfortable protection particularly in hot and humid conditions.

Features and benefits:

Comfort

- Traditional convex shape, with nose clip and twin strap design
- Comfortable, lightweight, off-the-face design

Safety

- Reliable, effective protection against fine particles
- Durable, collapse resistant inner shell

3M™ Cool Flow™ Valve

- Effective removal of heat build up provides a cooler and more comfortable wear
- Removes exhaled air and minimises the risk of misting eyewear

Compatible with

- Eyewear from 3M
- Hearing Protection from 3M

3M™ Particulate Respirators 8710E, 8810 and 8822, also available in handy packs of 5



	Classification	Protection	Nominal Protection Factor
3M™ Particulate Respirator 8812 (valved)	EN 149:2001+A1:2009 FFP1 NR D	Dust / Mist	4 FFP1
3M™ Particulate Respirator 8710E	EN 149:2001+A1:2009 FFP1 NR D	Dust / Mist	4 FFP1
3M™ Particulate Respirator 8822 (valved)	EN 149:2001+A1:2009 FFP2 NR D	Dust / Mist	12 FFP2
3M™ Particulate Respirator 8810	EN 149:2001+A1:2009 FFP2 NR D	Dust / Mist	12 FFP2
3M™ Particulate Respirator 8832	EN 149:2001+A1:2009 FFP3 NR D	Dust / Mist	50 FFP3



3M™ Filtering Facepiece Respirators

Comfort Series: 3M™ Aura™ Flat Fold 9400+ Series

3M™ Aura™ Respirators 9422+ and 9432+ provide reliable and comfortable protection from a range of airborne particulate hazards while minimising contamination risks to food or pharmaceutical production processes. They are made without staples or small detachable parts and are metal and visually detectable. Built on the innovative 3M™ Aura™ platform, the disposable respirators 9422+ and 9432+ fit a wide range of face shapes and sizes. Comfortable to wear and easy to breathe through, they are ideal for use in hot humid environments.

Features and benefits:

Metal detectable

- Embedded metal nose clip kept securely in place within the layers of the respirator to help ensure the safety of your production

Staple-free

- To help minimise contamination risks to your production

Sculpted nose panel

- Curved low profile design helps provide a good field of vision and improves compatibility with eyewear
- Conforms well to nose and eye contours

Embossed top panel

- Helps reduce the fogging of eyewear

Distinguishable non-food colour

- Bright blue for quick search recognition

Foldable – proprietary 3-panel design

- Ingenious 3-panel design fits a wide range of face shapes and sizes
- Accommodates your facial movements
- Collapse resistant: ideal for work in hot humid environments

3M™ Cool Flow™ Valve

- Effectively removes heat build up provides a cooler and more comfortable wear
- Removes exhaled air and minimises the risk of fogging eyewear

Low breathing resistance filter technology

- Combines the benefits of 3M's electret particulate filter material with advanced low breathing resistance filter technology
- Improved breathing ease and comfort

Chin tab

- Improves ease of donning and adjustment, to help achieve a comfortable fit

Individual packaging

- Hygienic individual packaging helps protect the respirator from contamination before use
- Allows practical storage and dispensing in the workplace



	Classification	Protection	Nominal Protection Factor	
3M™ Aura™ Particulate Respirator 9422+	EN 149:2001+A1:2009 FFP2 NR D	Dust/Mist	12	FFP2
3M™ Aura™ Particulate Respirator 9432+	EN 149:2001+A1:2009 FFP3 NR D	Dust/Mist	50	FFP3

Welding Fume Respirators

The 3M™ Welding Fume Respirators 9925 and 9928 provide lightweight, effective, comfortable and hygienic respiratory protection against dust, mist and metal fumes and resist clogging for extended use against welding fume. The convex shape enhances wearer comfort; the 3M™ Cool Flow™ Exhalation Valve reduces heat build up, particularly in hot humid work conditions. The 4-point adjustable straps and adjustable nose clip help achieve a comfortable fit. The 3M respirators 9925 and 9928 have been designed specifically for welding applications to provide protection against ozone and welding fumes, plus relief from nuisance odours.

Features and benefits:

Robust shell and cup design

- Flame retardant outer surface minimises the effect of welding splatter
- Conforms well to most face shapes and sizes
- Collapse-resistant

Soft inner face-seal ring (9928 only)

- Provides secure feel
- Improves wearer comfort

Can be hygienically cleaned if used for longer than one shift (3M™ Faceseal Cleaner 105)

3M™ Cool Flow™ valve

- Effective removal of heat build up provides a cooler and more comfortable wear
- Removes exhaled air and minimises the risk of misting eyewear

Colour coded valve lettering

- Easy to recognise protection level (FFP2) by colour coding

Carbon layer

- Provides protection against ozone gas and relief from nuisance level odours

Adjustable braided headbands

- Help provide comfort to face, head and neck

Compatible with

- Eyewear from 3M
- Hearing protection from 3M
- 3M™ Speedglas™ Welding Headtop
- Welding shields – low profile design for compatibility with welding shields



	Classification	Protection	Nominal Protection Factor	
3M™ Welding Particulate Respirator 9928	EN 149:2001+A1:2009 FFP2 R D	Dust/Mist/Ozone/ Nuisance level odours	10 for Ozone and particulates Below NPF for Nuisance Odours	FFP2
3M™ Welding Particulate Respirator 9925	EN 149:2001+A1:2009 FFP2 NR D	Dust/Mist/Ozone/ Nuisance level odours	10 for Ozone and particulates	FFP2

3M™ Filtering Facepiece Respirators

Speciality Series Respirators

The Speciality Series by 3M have been developed to provide lightweight, effective, comfortable and hygienic respiratory protection for particular working environments ranging from welding to waste sorting.

These speciality respirators which protect against dust and mist also feature an integrated activated carbon layer, offering relief from nuisance odours below nominal protection factor and, depending on the product type, from low levels of organic vapours or acid gases.

Features and benefits:

Robust shell and cup design

- Conforms well to most face shapes and sizes
- Maintains its shape well during use
- Collapse-resistant

3M™ High Performance Filter Material

- Effective filtration with easy breathing
- Consistent high quality performance

3M™ Cool Flow™ Valve

- Effective removal of heat build up provides a cooler and more comfortable wear
- Removes exhaled air and minimises the risk of misting eyewear

Carbon layer

- Provides protection against nuisance level organic vapours below nominal protection factor

Colour coded straps

- Easy to recognise performance level by colour coded straps

Compatible with

- Eyewear from 3M
- Hearing protection from 3M

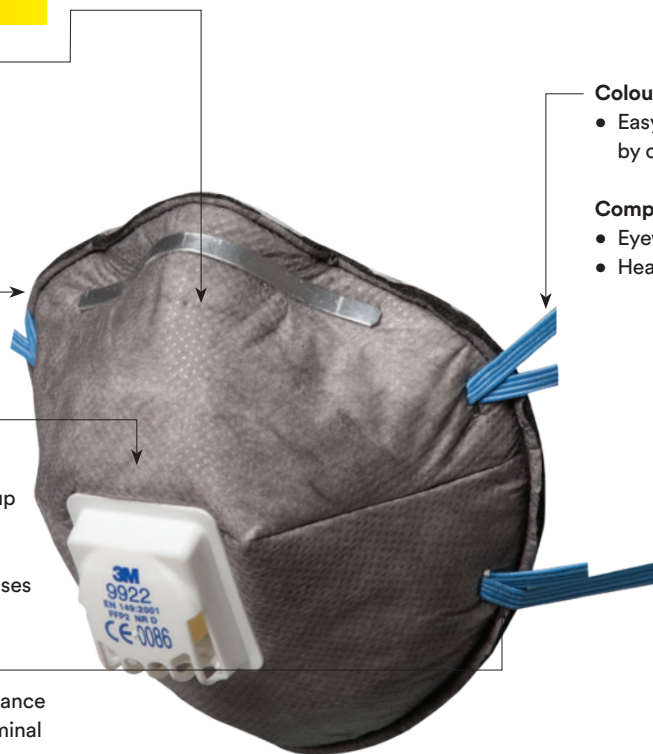

	Classification	Protection	Nominal Protection Factor
3M™ Speciality Particulate Respirator 9906	EN 149:2001+A1:2009 FFP1 NR D	Dust/Mist/Nuisance Level Hydrogen Fluoride	4 for Particulates Below NPF for Hydrogen Fluoride FFP1
3M™ Speciality Particulate Respirator 9913	EN 149:2001+A1:2009 FFP1 NR D	Dust/Mist/Nuisance Level Organic Vapour	4 for Particulates Below NPF for Organic Vapors FFP1
3M™ Speciality Particulate Respirator 9914	EN 149:2001+A1:2009 FFP1 NR D	Dust/Mist/Nuisance Level Organic Vapour	4 for Particulates Below NPF for Organic Vapors FFP1
3M™ Speciality Particulate Respirator 9915	EN 149:2001+A1:2009 FFP1 NR D	Dust/Mist/Nuisance Level Acid Gas	4 for Particulates Below NPF for Acid Gases FFP1
3M™ Speciality Particulate Respirator 9921	EN 149:2001+A1:2009 FFP2 NR D	Dust/Mist/Nuisance Level Acid Gas	12 for Particulates Below NPF for Acid Gases FFP2
3M™ Speciality Particulate Respirator 9922	EN 149:2001+A1:2009 FFP2 NR D	Dust/Mist/Nuisance Level Ozone	10 for Particulates and Ozone Below NPF for Organic Vapors FFP2
3M™ Speciality Particulate Respirator 9926	EN 149:2001+A1:2009 FFP2 NR D	Dust/Mist/Nuisance Level Acid Gas	12 for Particulates Below NPF for Acid Gases FFP2
3M™ Speciality Particulate Respirator 9936	EN 149:2001+A1:2009 FFP3 R D	Dust/Mist/Nuisance Level Acid Gas	50 for Particulates Below NPF for Acid Gases FFP3





Reusable Respirators

For prolonged periods of use, 3M™ Reusable Respirators offer exceptional value and quality, all combine comfort with ease of use. 3M™ Respirators have to pass strict quality control tests and provide a consistently high level of safety.

The choice of the right mask and filter type depends on your particular working environment and individual requirements. 3M can assist you to choose the protection that helps you achieve optimum results.

3M™ Reusable Respirators

The 4-Step Method

1. Identify the Hazards

Application	Hazard	Typical Protection
Painting, Spraying, Varnishing, Coating	Solvent-Based Paint**	A2P3 R
	Anti-Fouling Paint Spraying / Grinding	A2P3 R
	Water Soluble Paint	A1P2 R
	Solvents, Resins, Synthetic Resins**	A2P3 R
	Latex-Paint, Residual Solvents	A2P3 R
	Wood Preservatives	A1P2 R
Maintenance	Disinfection, Cleaning*	ABEK1P2 R
Decoration	Spray-On Glue, Foam, Varnish, Adhesive	A1P2 R
Waste Removal	Bacteria, Spores, Odours	A1P2 R
Agriculture	Pesticides, Insecticides	ABEK1P2 R
Wood Treatment	Bonding, Spray-On Glue	A2P3 R
Construction, Grinding, Cutting, Drilling	Tarring	A2P3 R
	Sealing	A1P2 R
	Spray Foam Insulation	A1P2 R
Coating	Organic Solvent/with boiling point less than 65 C	AXP3 R
	Ammonia Based Paint Remover	ABEK
	Polyurethane Coating**	ABEK1P3 R
	Solvent Based Varnish	A2
	Water Based Varnish	A1
Bonding	Solvent containing Adhesives	A1
Handling	Sulphur Dioxide	ABE
	Hydrochloric Acid	ABE
	Liquid Manure	ABEK
	Ammonia	K
	Formaldehyde	A1 + Form
	Hazardous goods storage/transport	ABEK1P3 R

Warning:

This guide is only an outline. It should not be used as the only means for selecting a respirator. Details regarding performance and limitations are set out on the respirator package and user instructions. Before using any of these respirators, the wearer must read and understand the user instructions for each product. Specific country legislation must be observed.

* excluding Formaldehyde

** for occurrence of Isocyanates, please contact the 3M Customer Helpline +44 (0) 870 60 800 60 or your local 3M office

2. Assess the Risk

Nominal Protection Factors (NPF) for reusable half and full face masks*

Filter Classification	NPF* with 3M Half Mask	NPF* with 3M Full Face Mask
P1	4	5
P2	12	16
P3	48	1000
Class 1 Gas and Vapour filters	50 or 1000ppm (whichever is lower)	2000 or 1000ppm (whichever is lower)
Class 2 Gas and Vapour filters	50 or 5000ppm (whichever is lower)	2000 or 5000ppm (whichever is lower)

AX-Filter for low boiling point (organic composition with a low boiling point under 65 °C). AX-Filter should only be fitted to 3M™ Full Face masks. AX filters may only be used for a single shift. A1 and A2 Filter for organic vapour with a boiling point above 65 °C.

* Country APF should be used where available.

Nominal Protection Factor (NPF) - a number derived from the maximum percentage of total inward leakage permitted in relevant European Standards for a given class of respiratory protective devices.

3M™ Reusable Respirators

3.2 Select the right filter and respirator

How do I select my filter?

**Consider the hazard**

Are they particles or particles, gases and vapours?

**Contaminant**

How much contaminant is in the air?

**Comfort and Convenience**

Filter protection level, weight, balance, field of view, compatibility with other equipment such as face shields.

**Mask type**

Is it a full face or half face mask?

**Compatibility**

What other Personal Protective Equipment is required e.g. welding shield?

**Environment**

Will the filter be caked in dust?

3M can help with free Select and Service Life Software.

3M™ Select and Service Life Software www.3M.com/SLS

How do I select my respirator?

3M™ offers a wide range of reusable respirators designed for user requirements. Respirators are compatible with one of the following filter platforms:

- 3M™ Bayonet Filter Series: Convenience and Versatility
- 3M™ Secure Click™ Series: Reliability and Comfort
- 3M™ Pro2000 Series: Heavy Duty and Low Maintenance

4. Train in fitting and use

Make sure you know how to use and maintain your Respiratory Protective Equipment to ensure effective respiratory protection. 3M sales and technical professionals can help you to define your training needs and can provide training and on-site consultations on all aspects of respiratory protection tailored to your individual needs. You'll also find easy to use training on our website: www.3M.eu/occsafety

Reusable respirator care and maintenance

3M™ Reusable Respiratory Equipment requires regular checks and maintenance to ensure optimum performance and protection for the wearer. In addition to potentially reducing protection levels, poor maintenance can also reduce the effective lifetime of the equipment, resulting in the additional cost of replacement. Guidance on the appropriate checks is provided in the instruction booklets with each new item.

3M™ Reusable Respirators

3M™ Bayonet Filter Series

3M™ Reusable Respirators and Filters at a glance

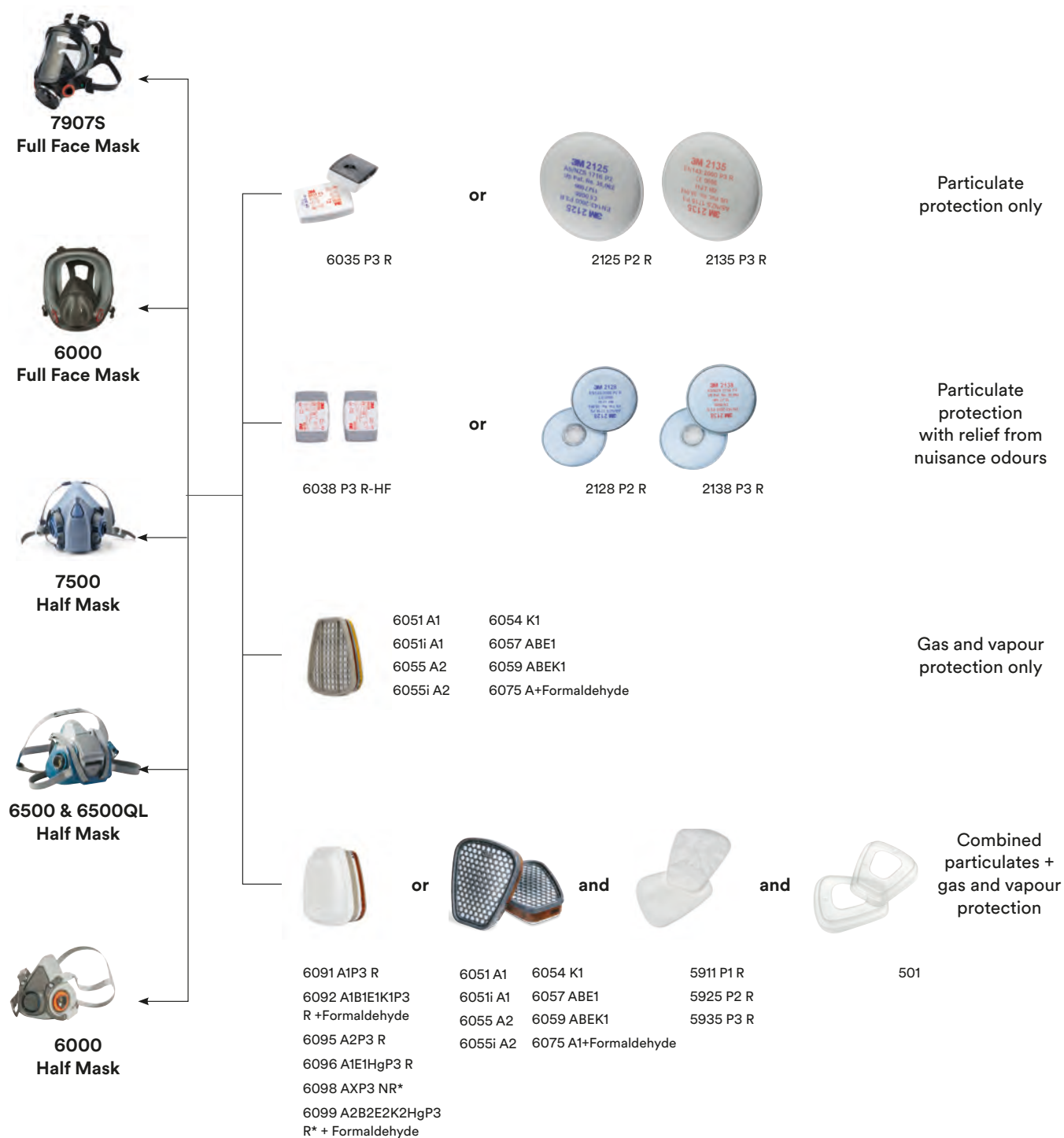

*full face only

3M™ Reusable Respirators

3M™ Secure Click™ Filter Series



3M™ Pro2000 Series Filter Series

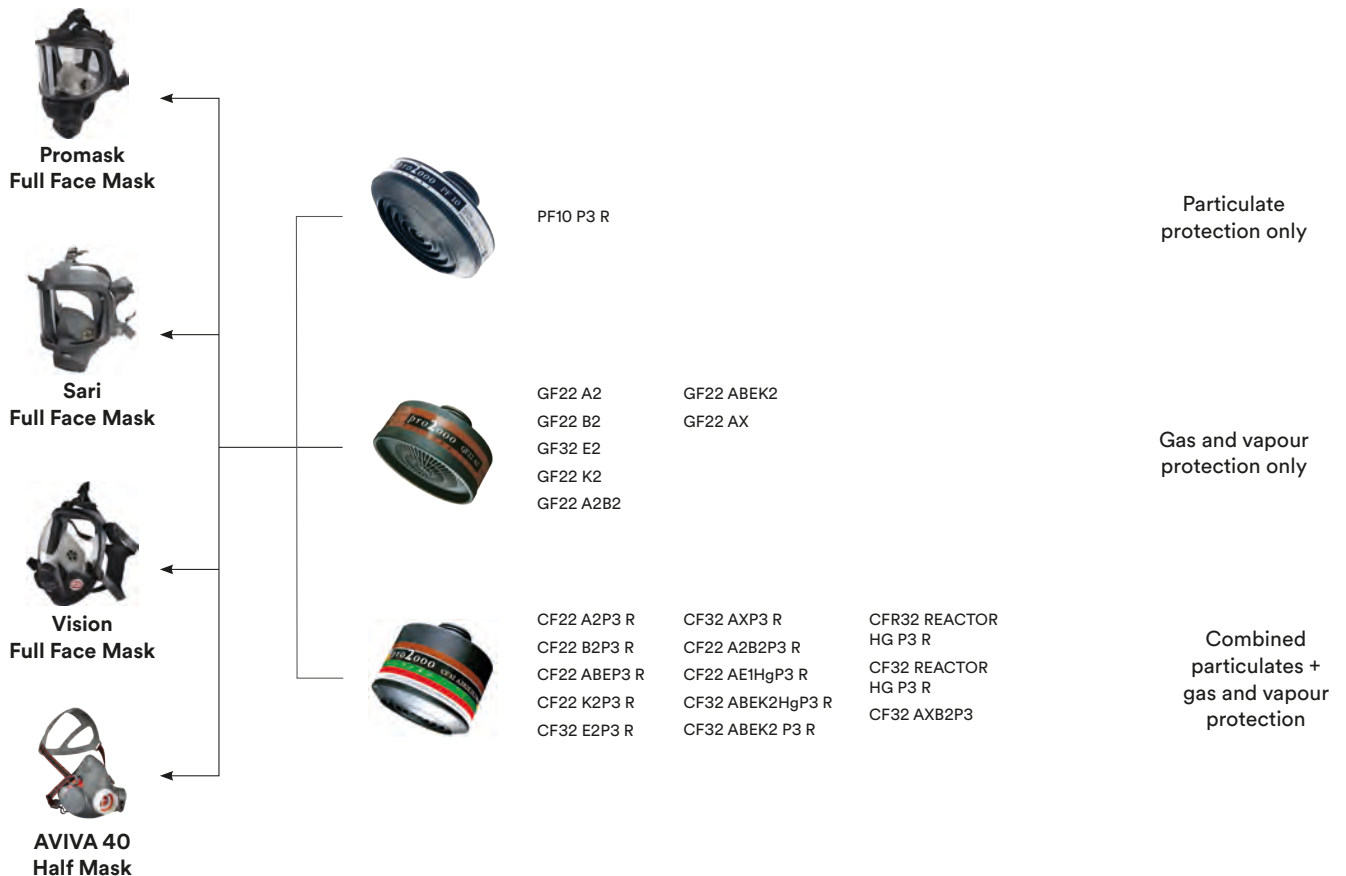

3M™ Reusable Respirators

Respirator Select and Service Life Software

3M have designed state of the art software to help make the selection of 3M™ Respirators and filters easier. The user-friendly software also helps users estimate the service life of 3M™ Gas and Vapour Filters and helps determine how to use the NEW 3M™ 6051i and 6055i filters that feature the 3M™ End of Service Life Indicator (ESLI).

The 3M™ Select and Service Life Software simplifies and speeds up the selection of 3M™ Respirators through a user-friendly interface that allows the user to enter contaminants and their concentrations.

With the ability to analyse more than 700 different chemicals, and mixtures of chemicals, the software provides a series of prompts to the user to select an appropriate respirator. A record is also provided of the choices made by the user.

Respiratory filters have a limited service life, this is the estimated period of time before breakthrough of a chemical for a specific filter. Respiratory protection standards and/or good practice often require users of chemical filter respirators to implement a filter change schedule based on "objective information or data" to help prevent worker overexposure.

The 3M™ Select and Service Life Software offers the additional capability of estimating the frequency of replacement of 3M™ Gas and Vapour Filters. The software calculates service life based on workplace conditions such as contaminant concentration. This information can then be used to establish a filter change schedule.

ESLI Software



The 3M™ Gas & Vapour Service Life Indicator Filters 6051i and 6055i feature an End of Service Life Indicator (ESLI). The ESLI software can help you determine if you can rely on the ESLI as your primary filter change plan.

3M™ Select Software



3M™ Select Software is designed to help you choose the appropriate 3M™ Respirator for your work environment.

3M™ Service Life Software

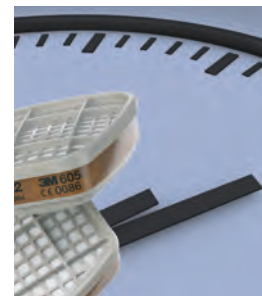

The Service Life calculation is designed to help you estimate the service life of selected 3M™ Gas and Vapour Filters.

To use the software simply visit:
www.3M.com/SLS





3M™ Reusable Respirators

3M™ Bayonet Filter Series

Simply twist and click to connect your preferred combination of 3M filters and bayonet facepieces with the easy to use 3M™ Bayonet Filter Attachment System (excluding 6098 and 6099 which need to be used with 3M full face respirators). 3M Bayonet Filters provide protection against a range of particulates, gases and vapours, or a combination of hazards.

3M™ Particulate Filters

Particulate filters protect only against particles i.e. dust, mists, aerosols, smoke, mould, bacteria and so on. Some of our filters also provide relief from nuisance odours.

3M™ Particulate Filters 6035/6038 Series

	Filter	Protection level	Protection against
	6035	P3 R	Solid and liquid particles – in solid plastic case for rough application
	6038	P3 R	Solid and liquid particles. Hydrogen Fluoride gas up to 30ppm and relief from nuisance level organic vapours and acid gases below nominal protection factor in solid plastic case for tough applications
	502*		Filter retainer

3M™ Particulate Filters 5000 Series

	Filter	Protection level	Protection against
	5911*	P1 R	Solid and liquid particles
	5925*	P2 R	Solid and liquid particles
	5935*	P3 R	Solid and liquid particles
	501		Filter retainer
	603		Filter retainer

3M™ Particulate Filters 2000 Series

	Filter	Protection level	Protection against
	2125	P2 R	Solid and liquid particles
	2128	P2 R	Solid and liquid particles, ozone protection up to 10 x nominal protection factor, organic vapours/ acid gas
	2135	P3 R	Solid and liquid particles
	2138	P3 R	Solid and liquid particles, ozone protection up to 10 x nominal protection factor, organic vapours/acid gas
	502*		Filter retainer

3M™ Reusable Respirators

3M™ Combination Filters

Protect against both particulates and gases. Different combinations of particulate and gas and vapour filters are used depending on the gases or vapours present in the air

3M™ Gas, Vapour and Particulate Filters 6000 Series

	Filter	Protection level	Protection against
	6091	A1P3 R	Organic gases and vapours bp> 65°C and particulates
	6092	A1B1E1K1P3 R + Formaldehyde	Organic vapours bp>65°C, inorganic vapours, acid gases, ammonia and its derivatives, formaldehyde up to 10ppm and particulates
	6095	A2P3 R	Organic gases and vapours bp>65°C and particulates
	6096	A1E1HgP3 R	Organic vapours bp>65°C, acid gases, mercury and particulates
	6098*	AXP3 NR	Organic vapours bp<65°C and particulates
	6099*	A2B2E2K2HgP3 R + formaldehyde	Organic vapours bp>65°C, inorganic vapours, acid gases, ammonia and its derivatives, mercury, formaldehyde up to 10ppm and particulates

3M™ Gas and Vapour Filters

Gas and vapour filters protect only against gases and vapours. These can be combined with some particulate filters if needed.

3M™ Gas and Vapour Filters with 3M™ Service Life Indicator 6000i Series

	Filter	Protection level	Protection against
	6051i	A1	Organic gases and vapours bp>65°C
	6055i	A2	Organic gases and vapours bp>65°C

3M™ Gas and Vapour Filters 6000 Series

	Filter	Protection level	Protection against
	6051	A1	Organic gases and vapours bp>65°C
	6054	K1	Ammonia and derivatives
	6055	A2	Organic vapours bp>65°C
	6057	ABE1	Organic vapours bp>65°C, inorganic vapours and acid gases
	6059	ABEK1a	Organic vapours bp>65°C, inorganic vapours, acid gases, ammonia and its derivatives
	6075	A1+ formaldehyde	Organic vapours bp>65°C and formaldehyde up to 10ppm

* Please see the 6051i and 6055i User Instructions or the 3M™ Select and Service Life Software to determine if these filters are appropriate as a primary change out method for your work environment. It is important to change your gas and vapour filters at the right time; using the filter for longer can lead to break-through of hazard into the mask. Service life is the terms used to describe how long a set of filters can be used before they need to be changed. The ESLI is only appropriate as a primary change out method for certain organic vapours and exposure concentrations, must also be less than the workplace exposure limit (WEL).

3M™ Reusable Respirators

3M™ Pro2000 Filter Series

Align and screw your Pro2000 DIN Thread filters to compatible 3M half masks and full facepieces (excluding compatible full face respirators). 3M Pro2000 Filters provide protection against a range of particulates, gases and vapours, or a combination of hazards.

3M™ Gas and Vapour Filters

Gas and vapour filters protect only against gases and vapours. These can be combined with some particulate filters if needed.

3M™ Gas & Vapour Filters Pro2000 Series

Filter	Protection level	Protection against	
	GF22 A2	A2	Gases and vapours from organic compounds with a boiling point above 65°C
	GF22 B2	B2	Inorganic gases and vapours, e.g. chlorine, hydrogen sulphide, hydrogen cyanide
	GF32 E2	E2	Acid gases and vapours, e.g. sulphur dioxide
	GF22 K2	K2	Ammonia and organic ammonia derivatives
	GF22 A2B2	A2B2	Gases and vapours from organic compounds with a boiling point above 65°C. Inorganic gases and vapours, e.g. chlorine, hydrogen sulphide, hydrogen cyanide
	GF32 ABEK2	ABEK2	Gases and vapours from organic compounds with a boiling point above 65°C. Inorganic gases and vapours, e.g. chlorine, hydrogen sulphide, hydrogen cyanide. Acid gases and vapours, e.g. sulphur dioxide. Ammonia and organic ammonia derivatives.
	GF32 AX	AX	Gases and vapours from organic compounds with a boiling point less than, or equal to, 65°C. Single Use Only

3M™ Particulate Filters

Particulate filters protect only against particles i.e. dust, mists, aerosols, smoke, mould, bacteria and so on.

3M™ Particulate Filters Pro2000 Series

Filter	Filter	Protection level	Protection against
	PF10 P3	P3 R	Solid and liquid particles, toxic and radioactive particles, micro-organisms (e.g. bacteria and viruses) and enzymes

3M™ Reusable Respirators

3M™ Combination Filters

Protect against both particulates and gases. Different combinations of particulate and gas and vapour filters are used depending on the gases or vapours present in the air.

3M™ Gas, Vapour and Particulate Filters Pro2000 Series

Filter	Protection level	Protection against
 CF22 A2P3	A2P3 R	Gases and vapours from organic compounds with a boiling point above 65°C. Solid and liquid particles, toxic and radioactive particles, micro-organisms (e.g. bacteria and viruses) and enzymes
CF22 B2P3	B2P3 R	Inorganic gases and vapours. Solid and liquid particles, toxic and radioactive particles, micro-organisms (e.g. bacteria and viruses) and enzymes
CF22 A2B2E1P3	A2B2E1P3 R	Gases and vapours from organic compounds with a boiling point above 65°C. Inorganic gases and vapours. Acid gases and vapours. Solid and liquid particles, toxic and radioactive particles, micro-organisms (e.g. bacteria and viruses) and enzymes
CF22 K2P3	K2P3 R	Ammonia and organic ammonia derivatives. Solid and liquid particles, toxic and radioactive particles, micro-organisms (e.g. bacteria and viruses) and enzymes
CF32 E2P3	E2P3 R	Acid gases and vapours. Solid and liquid particles, toxic and radioactive particles, micro-organisms (e.g. bacteria and viruses) and enzymes
CF32 AXP3	AXP3 R	Gases and vapours from organic compounds with a boiling point less than, or equal to, 65°C. (AX Filter single use only). Solid and liquid particles, toxic and radioactive particles, micro-organisms (e.g. bacteria and viruses) and enzymes
CF22 A2B2P3	A2B2P3 R	Gases and vapours from organic compounds with a boiling point above 65°C. Inorganic gases and vapours. Solid and liquid particles, toxic and radioactive particles, micro-organisms (e.g. bacteria and viruses) and enzymes
CF22 AE1HgP3	AE1HgP3 R	Gases and vapours from organic compounds with a boiling point above 65°C. Acid gases and vapours. Mercury (maximum usage time of Hg filter is 50 hours). Solid and liquid particles, toxic and radioactive particles, micro-organisms (e.g. bacteria and viruses) and enzymes
CF32 ABEK2HGP3 (with cap cover)	ABEK2HgP3 R	Gases and vapours from organic compounds with a boiling point above 65°C. Inorganic gases and vapours. Acid gases and vapours. Ammonia and organic ammonia derivatives. Mercury (maximum usage time of Hg filter is 50 hours). Solid and liquid particles, toxic and radioactive particles, micro-organisms (e.g. bacteria and viruses) and enzymes
CF32 ABEK2P3	ABEK2P3 R	Gases and vapours from organic compounds with a boiling point above 65°C. Inorganic gases and vapours. Acid gases and vapours. Ammonia and organic ammonia derivatives. Solid and liquid particles, toxic and radioactive particles, micro-organisms (e.g. bacteria and viruses) and enzymes
CFR32 REACTOR-HGP3 (reduced opening)	REACTOR HGP3 R	Radioactive agents and Mercury (maximum usage time of Hg filter is 50 hours). Solid and liquid particles, toxic and radioactive particles, micro-organisms (e.g. bacteria and viruses) and enzymes
CFR32 ABEK2P3 (reduced opening and foil bag)	ABEK2P3 R	Gases and vapours from organic compounds with a boiling point above 65°C. Inorganic gases and vapours. Acid gases and vapours. Ammonia and organic ammonia derivatives. Solid and liquid particles, toxic and radioactive particles, micro-organisms (e.g. bacteria and viruses) and enzymes
CF32 REACTOR-HGP3	REACTOR HGP3 R	Radioactive agents and Mercury (maximum usage time of Hg filter is 50 hours). Solid and liquid particles, toxic and radioactive particles, micro-organisms (e.g. bacteria and viruses) and enzymes
CF32 AXB2P3	AXB2P3 R	Gases and vapours from organic compounds with a boiling point less than, or equal to, 65°C. Inorganic gases and vapours. Solid and liquid particles, toxic and radioactive particles, micro-organisms (e.g. bacteria and viruses) and enzymes
CF32 ABEK2P3	ABEK2P3 R	Gases and vapours from organic compounds with a boiling point above 65°C. Inorganic gases and vapours. Acid gases and vapours. Ammonia and organic ammonia derivatives. Solid and liquid particles, toxic and radioactive particles, micro-organisms (e.g. bacteria and viruses) and enzymes

3M™ Reusable Respirators

3M™ Secure Click Filter Range

Work with the confidence, provided by the all new Secure Click connection, that filters/cartridges are installed properly. Simply align the connections and push to hear a click. Experience greater breathability and comfort provided by the world's first quad-flow gas and vapour filter/combination filter system

3M™ Combination Filters

Protect against both particulates and gases. Different combinations of particulate and gas and vapour filters are used depending on the gases or vapours present in the air

3M™ Secure Click Gas, Vapour and Particulate Filters

	Filter	Protection level	Protection against
	D8095	A2P3 R	Organic gases and vapours bp>65°C and Particulates
	D8094	ABEKP3 R	

3M™ Gas and Vapour Filters

Gas and vapour filters protect only against gases and vapours. These can be combined with some particulate filters if needed.

3M™ Secure Click Gas and Vapour Filters

	Filter	Protection level	Protection against
	D8051	A1	Organic gases and vapours bp>65°C
	D8055	A2	Organic vapours bp>65°C
	D8059	ABEK1a	Organic vapours bp>65°C, inorganic vapours, acid gases, ammonia and its derivatives

3M™ Particulate Filters

Particulate filters protect only against particles i.e. dust, mists, aerosols, smoke, mould, bacteria and so on. Some of our filters also provide relief from nuisance odours.

3M™ Secure Click Particulate Filters

	Filter	Protection level	Protection against	
	D3125	P2 R	Solid and liquid particles	
	D3128	P2 R	Solid and liquid particles, ozone protection up to 10 x nominal protection factor, organic vapours/acid gas	
	D3135	P3 R	Solid and liquid particles	
	D3138	P3 R	Solid and liquid particles, ozone protection up to 10 x nominal protection factor, organic vapours/acid gas	
	D7915	P1 R	Solid and liquid particles	
	D7925	P2 R	Solid and liquid particles	
	D7935	P3 R	Solid and liquid particles	
	D701			Filter Retainer

3M™ Reusable Respirators

3M™ Secure Click™ Half Mask Reusable Respirator HF-800 Series

Designed with smart and intuitive features, the 3M™ Secure Click™ Half Mask Reusable Respirator HF-800 Series helps protect workers from particulates and a wide variety of gases and vapours when used with approved 3M™ Secure Click™ filters and cartridges.

Greater breathability and comfort is provided by the world's first quad flow cartridge system.

Features and Benefits:

Speaking Diaphragm

- Designed to help provide easier communication while working

Unique Filter and Cartridge Connection

- Align the connections and push to hear a click
- Two dual-flow cartridges on each respirator combine four airflow paths for easier breathing
- Swept back filter design for compatibility with certain welding and grinding shields

Exhalation Valve

- Helps direct exhaled breath and moisture downward

Push Button Seal Check

- Provides increased worker confidence that the respirator is being worn properly

Easy-Adjust Buckle

- Simple two-way adjustability: pull straps to tighten, squeeze wings to loosen

Patented Silicone Flex-Joint Faceseal

- Provides a softer feel for more comfort on the wearer's face



Hear it:



Check it:



Feel it:



Say it:

Compatible with:



3M™ S-200+ Supplied Air System
3M Protective Eyewear
3M Hearing Protection

Work with the confidence, provided by the all new Secure Click™ connection, that filters/cartridges are installed properly. Simply align the connections and push to hear a click.

Increase worker confidence that the respirator is being worn properly with the easy, one-touch, user seal check.

Experience the greater breathability and comfort provided by the world's first quad-flow gas and vapour filter/combination filter system.

Utilise the speaking diaphragm designed to help provide easier communication while working.

3M™ Reusable Respirators

3M™ Maintenance Free Reusable Respirators 4000+ Series

Engineered for improved breathing ease, this evolution of 3M's most popular maintenance-free reusable half mask is convenient to use, reassuringly reliable and now offers measurable improvements in comfort. With no parts assembly or maintenance required this simple, lightweight, well balanced respirator offers reliable respiratory protection against a range of gases, vapours and particulates typically found in a variety of industries. A unique bonded carbon technology allows the respirator to sit close to the face and fit well under many other types of protective equipment, providing an undisturbed field of vision and a more comfortable worklife.

Features and Benefits:

Comfortable, Effective Protection

- New enhanced exhalation valve assembly reduces breathing resistance by over 30%
- Low profile design for better peripheral vision
- Lightweight, well balanced design
- Soft, non-allergenic material with textured face seal
- Proven to consistently exceed EU standard requirements for breathing ease

Convenience

- Ready-to-use, maintenance-free construction with integrated filter
- Four versions available, each offering protection against differing hazards throughout industry
- Resealable bag provides convenient and clean storage between uses

Cooler Wear

- Central position of the exhalation valve for effective removal of heat and moisture build up within facepiece

Adjustability

- Helps to achieve a stable secure fit
- Easy to fasten neck strap

Accessories

- 3M™ Overspray Guard 400+ is available to help prolong the life of the main particulate filters



	Classification	Protection	
3M™ Reusable Respirator 4251+	EN 405:2001+A1:2009	Organic Vapour + Particulates	FFA1P2 R D
3M™ Reusable Respirators 4255+	EN 405:2001+A1:2009	Organic Vapour + Particulates	FFA2P3 R D
3M™ Reusable Respirator 4277+	EN 405:2001+A1:2009	Organic Vapour / Inorganic Vapours + Acid Gas / Particulates	FFABE1P3 R D
3M™ Reusable Respirator 4279+	EN 405:2001+A1:2009	Organic Vapour / Inorganic Vapours + Acid Gas / Ammonia / Particulates	FFABEK1P3 R D

3M™ Reusable Respirators

3M™ Reusable Half Masks 7500 Series

3M™ Reusable Half Face Mask 7503 has a bayonet style twin filter design that fits a broad range of lightweight filters. Our 7500 Series reusable mask has a 3M™ Cool Flow™ Valve, a soft sealing surface for comfort, and a unique head harness with an optional drop down strap design.

Features and benefits:

Head harness

- Balanced, secure fit
- Reduced pressure and tension points

Facepiece

- Available in 3 sizes, distinguished by colour
- Drop Down feature for added convenience during breaks
- Soft silicone face piece material for comfort and durability
- Thin nose bridge area for more comfort
- Low weight of 136g

3M™ CoolFlow™ Exhalation Valve

- Less exhalation resistance and easier breathing
- Effective removal of heat build up provides a cooler and more comfortable wear
- Removes exhaled air to minimise the risk of fogging eyewear

Low Profile Design

- Minimises interference with field of view
- Minimises dirt traps
- Sleek look and feel

3M™ Bayonet Filter Connection System

- Twin filter design provides lower breathing resistance, even weight distribution and balanced fit
- Optical marking of attachment point
- Flexible filter system for gas, vapour and particulate filters
- Optional supplied air connection.

Ready to Use Respirator Kits

- Available in convenient Ready to Use Kits, containing facepiece, filters, filter retainer



	Classification	Size	Colour
3M™ Half Mask 7501	EN140:1998	Small	Grey Blue
3M™ Half Mask 7502	EN140:1998	Medium	Light Blue
3M™ Half Mask 7503	EN140:1998	Large	Dark Blue

Compatible with:

- 3M S-200+ Supplied Air System
- 3M Protective Eyewear
- 3M Hearing Protection
- 3M Bayonet Filter Connection System

3M™ Reusable Half Masks 6500 Series

The 3M™ Reusable Half Masks 6500 Series have been designed with tough and dirty work environments in mind. Stay productive and protected – the 6500 Series delivers durability and stability with a firm, lightly textured silicone face seal and strong body construction.

Features and benefits:

Overmoulded, Low-Profile Design

- Simplified cleaning and maintenance with minimal parts and crevices
- Advanced half mask design for a wide field of view

Adjustable Head Harness Assembly

- Optimum fit and comfort with three-size adjustable head cradle and durable harness straps

Silicone Face Seal

- Provides comfort and stability with a soft but firm face seal
- Extended product life due to resilient silicone material
- Keeps its shape in high-heat environments

3M™ Bayonet Connection

- Flexible bayonet system for connection to a wide range of 3M™ gas, vapour and particulate filters

Valve Cover Design

- Directs exhaled breath and moisture downward
- Easy positive pressure seal check

3M™ Cool Flow™ Exhalation Valve

- Enhanced comfort by reducing heat and moisture
- Less exhalation resistance makes breathing easier

Quick Latch (QL) - Drop Down Mechanism*

- Easy on and off as you move in and out of contaminated areas
- No need to remove your safety helmet or face shield when lowering or raising your respirator



	Classification	Size	Quick Latch Mechanism?
3M™ Half Mask 6501QL	EN140:1998	Small	Yes
3M™ Half Mask 6502QL	EN140:1998	Medium	Yes
3M™ Half Mask 6503QL	EN140:1998	Large	Yes
3M™ Half Mask 6501	EN140:1998	Small	No
3M™ Half Mask 6502	EN140:1998	Medium	No
3M™ Half Mask 6503	EN140:1998	Large	No

Compatible with:

- 3M S-200+ Supplied Air System
- 3M Protective Eyewear
- 3M Hearing Protection
- 3M Bayonet Filter Connection System

3M™ Reusable Respirators

3M™ Reusable Half Masks 6000 Series

The 3M™ Reusable Half Masks 6000 Series are economical, low-maintenance, simple to handle and lightweight. Available in three sizes, all masks have the 3M™ Bayonet Connection System allowing connection to a broad range of twin filters to protect against gases, vapours and particulates depending on your individual needs.

Features and benefits:

Head harness

- Cradle suspension for comfortable fit
- Easy to fasten neck strap

Facepiece

- Three colour coded sizes for easier identification
- Lightweight elastomeric material for comfort during long periods of work
- Ultra-low weight of 82g

Low Profile Design

- Minimises interference with field of view

3M™ Bayonet Filter Connection System

- Twin filter design provides lower breathing resistance
- Better weight distribution and more balanced fit
- Improved peripheral vision
- Safe and secure fit
- Optical marking of attachment point
- Flexible filter system for gas, vapour and particulate filters
- Optional supplied air connection.

Ready to Use Respirator Kits

- Available in convenient Ready to Use Kits, containing facepiece, filters, filter retainer



	Classification	Size	Colour
3M™ Half Mask 6100	EN140:1998	Small	Light Grey
3M™ Half Mask 6200	EN140:1998	Medium	Grey
3M™ Half Mask 6300	EN140:1998	Large	Dark Grey

Compatible with:

- 3M S-200+ Supplied Air System
- 3M Protective Eyewear
- 3M Hearing Protection
- 3M Bayonet Filter Connection System

3M™ Reusable Half Masks AVIVA 40

AVIVA 40 Half Mask has been designed with user comfort and protection in mind. With a wide range of compatible filters, AVIVA 40 is suitable for protecting against a number of respirable hazards. AVIVA 40 Half Mask utilises the 3M™ Pro2000 Series filter attachment system.

Features and benefits:

Facepiece

- Seal check button - when pressed during exhaling, the mask inflates slightly showing a good seal has been achieved
- Standby positioning enables users to temporarily remove the mask without requiring the removal of headwear
- Nose pinch - allows for integration with eyewear
- Made from Thermoplastic Elastomer (TPE).
- Integrated voice panel, for enhanced voice intelligibility
- Available in 3 sizes: Designed to suit a number of face shapes.

User Comfort

- Reflex seal: Contours to the face, flexing with wearer movement. Designed to aid wearer comfort whilst sealing to the face.
- Comfortable, durable, low profile head cradle

Ready to Go Protection

- Also available as a Ready to Use Kit:
- Consisting of a mask and filters in a resealable tub for convenience and to ensure the mask is stored and transported correctly.

Compatible with:

- 3M™ Pro2000 Filter Attachment System



	Classification	Size
AVIVA 40 Half Mask	EN140:1998	Small
AVIVA 40 Half Mask	EN140:1998	Medium
AVIVA 40 Half Mask	EN140:1998	Large

3M™ Reusable Respirators

3M™ Reusable Full Face Mask 7907S

The 3M™ Full Face Mask 7907S offers durability and safety for demanding tasks that require face and respiratory protection. The 3M™ Bayonet Connection System offers a broad range of twin lightweight filters to protect against gases, vapours and particulates depending on your individual needs.

The 7907S full face mask by 3M can also be used with Supplied Air Systems by 3M for your increased convenience and flexibility.

Features and benefits:

Six Strap Head harness

- Easy and secure fit for maximum safety
- Provides greater stability
- Easy release buckles

Full Face Lens

- Large polycarbonate lens with wide field of view
- Spectacle kit and lens covers available

Facepiece

- Double face sealing for safe, secure fit to most face sizes
- Silicone rubber one-size-fits-all
- Highly durable
- Range of consumables available
- Speech Diaphragm for improved communication

3M™ Bayonet Filter Connection System

- Twin filter design provides lower breathing resistance
- Better weight distribution and more balanced fit
- Improved peripheral vision
- Safe and secure fit
- Optical marking of attachment point
- Flexible filter system for gas, vapour and particulate filters
- Optional supplied air connection.

Compatible with:

- 3M Supplied Air Systems
- 3M Hearing Protection
- 3M Bayonet Filter Connection System



3M™ Reusable Full Face Masks 6000 Series

The 3M™ Full Face Masks 6000 Series are simple to handle and comfortable to wear. The exhalation port provides increased durability and is easy to keep clean. Available in three sizes, all masks have the 3M™ Bayonet Connection System enabling connection to a broad range of twin lightweight filters to protect against gases, vapours and particulates depending on your individual needs.

Features and benefits:

4 Strap Head Suspension

- Easy to put on and take off
- Well balanced

Full Face Piece

- Soft, non-allergenic elastomeric face piece
- Extremely lightweight (400 grams) for high comfort
- Minimised dirt traps to stay clean
- Sleek look and feel

Full Face Lens

- Broad field of vision
- Polycarbonate lens, scratch and impact resistant to EN1 66:2001 B

3M™ CoolFlow™ Exhalation Valve

- Less exhalation resistance and easier breathing
- Effective removal of heat build up provides a cooler and more comfortable wear
- Reduces valve vibration

3M™ Bayonet Filter Connection System

- Twin filter design provides lower breathing resistance
- Better weight distribution and more balanced fit
- Improved peripheral vision
- Safe and secure fit
- Optical marking of attachment point
- Flexible filter system for gas, vapour and particulate filters
- Optional supplied air connection.

Compatible with:

- 3M Supplied Air Systems
- 3M Hearing Protection
- 3M Bayonet Filter Connection System



	Classification	Size
3M™ Full Face Mask 6700	EN 136:1998 (Class 1)	Small
3M™ Full Face Mask 6800	EN 136:1998 (Class 1)	Medium
3M™ Full Face Mask 6900	EN 136:1998 (Class 1)	Large

3M™ Reusable Respirators

3M™ Reusable Full Face Mask Vision Series

The Vision full face mask provides comfort, ease of use and wearer appeal. With a choice of mask sizes and filter positions, Vision can be suitable for a wide range of users and applications.

Vision series masks are compatible with the Pro2000 Series of filters, with a wide variety of compatible filters for use in many applications.

Features and Benefits:

Visor

- Vision features a large visor with a virtually unrestricted (98%) field of vision and is designed to reduce visual distortion
- The visor is moulded in polycarbonate, providing eye and face protection
- The visor is hard coated to offer excellent scratch resistance for a long service life
- The positioning of the filter permits good downwards visibility

User comfort

- Available in 2 sizes
- Liquid Silicon Rubber (LSR) faceseal to enhance user comfort. LSR is a durable material but remains soft against the skin and is highly flexible, conforming to the users face
- The broad contact area of the faceseal is designed to minimise pressure points and seals effectively without over-tightening the head harness
- The inner mask is moulded in TPE. The mask ensures a directional air flow to help prevent misting of the visor and to maintain low carbon dioxide levels. A matte finish helps to prevent reflective glare on the inside of the visor

Lightweight

- The mask weighs just over 600g

Filter Connection

- Vision RFF1000 features a front filter fitting
- Vision RFF4000 features a side filter fitting
- Vision Series masks are compatible with the Pro2000 Series of filters, including options for particulate, gas and combination hazards



3M™ Reusable Full Face Mask Vision Classification: EN 138:1998 Class 2

3M™ Full Face Mask Vision RFF1000
– front filter fitting – Medium / Large

3M™ Full Face Mask Vision RFF1000
– front filter fitting – Medium

3M™ Full Face Mask Vision RFF1000
– front filter fitting – Small

3M™ Full Face Mask Vision RFF4000
– side filter fitting – Medium / Large

3M™ Full Face Mask Vision RFF4000
– side filter fitting – Medium

3M™ Full Face Mask Vision RFF4000
– side filter fitting – Small

3M™ Reusable Respirators

3M™ Reusable Full Face Mask Promask

The Promask Full Face Mask is a multi-function respirator designed to provide comfort and protection against a wide range of respiratory hazards. Proven in several industrial applications, Promask utilises a T-Profile face seal design, providing an efficient seal with minimal pressure on the face.

Features and benefits:

Panoramic Visor

- Large visor with a wide field of view
- Choice of Polycarbonate or optional high heat visor
- Clear inner mask designed to improve downwards vision

Full shift comfort

- Available in 2 sizes
- Proven, durable construction for use in extreme applications
- Choice of halo-butyl compound or Silicone face mask
- Five point head harness for a secure, stable fit

Filter connection

- Side fitting filter port for improved forwards vision
- Single filter design
- Compatible with the Pro2000 Series of filters including particulate, gas and vapour and combination filters



3M™ Reusable Full Face Mask Sari

The Sari Full Face Mask is a multi-function respirator designed to provide durable protection against a wide range of respiratory hazards. Proven in several industrial applications, Sari is available in natural rubber or silicone variants to ensure suitability for a wide range of users.

Features and benefits:

Panoramic Visor

- Large visor gives the wearer a panoramic field of vision
- Choice of Polycarbonate or optional Triplex visor for high heat applications
- Visor misting is reduced by directing inhalation air flow across the inside of the visor

Full shift comfort

- Wide sealing edge for increased comfort
- Fully adjustable five point elasticated harness features quick release buckles for donning and doffing

Clear Communication

- Safeguarded speech diaphragm affords communication

Filter Connection

- Front fitting filter port
- Single filter design
- Compatible with the Pro2000 Series of filters including particulate, gas and vapour and combination filters

Durable Construction

- Durable construction, ideal for use in tough environments
- Available in 3 face seal materials
- Designed for minimum maintenance – inhalation and exhalation valves are easy to check and replace without tools







Powered and Supplied Air Respirators

Providing clean breathing air is essential when working in areas where hazardous contaminants are present. 3M offers an extensive and flexible range of industrial powered and supplied air respirators, developed especially for the toughest environments.

These respiratory protective systems offer comfortable protection against multiple hazards and their ease-of-use enables improved productivity in the workplace. 3M is available to support the user in the correct selection, training and proper use of these products.

3M™ Powered and Supplied Air Respirators

Should I choose:

A powered air system?

- Incorporates a battery powered motorised fan to draw air through a filter
- Cannot be used to protect against substances with poor warning properties (taste/smell)
- Must not be used in conditions that are Immediately Dangerous to Life or Health (IDLH)
- Suitable for use over long shifts - reduced breathing resistance
- Can offer integrated head, eye and face protection

A supplied air system?

- Air is supplied from a compressor (compressed air must be of breathable quality)
- Can be used to protect against substances with poor warning properties (taste/smell)
- Must not be used in conditions that are Immediately Dangerous to Life or Health (IDLH)
- Suitable for use over long shifts – reduced breathing resistance
- Can offer integrated head, eye and face protection



Powered air respirators



3M™ Jupiter™
Powered Air Turbo



3M™ Versaflo™
Powered Air
Turbo TR-300+



3M™ Versaflo™
Powered Air
Turbo TR-600



3M™ Versaflo™
Powered Air
Turbo TR-800



3M™ Scott™
Duraflow Powered
Air Turbo



3M™ Scott™ Proflow
Powered Air Turbo



3M™ Scott™
Tornado Powered
Air Turbo



Supplied air respirators



3M™ Versaflo™
Regulators V-Series



3M™ S-200+
Supplied
Air System



3M™ Aircare™
Filtration Units

3M™ Powered and Supplied Air Respirators

Modular Systems



The modular respirator system is a comprehensive approach to worker protection systems based on comfortable-to-wear modules. All modular headtops, air delivery units and breathing tubes are compatible with one another. Users can mix and match parts as they move from one environment to another, or from one application to the next. It is the ultimate in flexibility for handling changing user environments.

Individual Systems



The individual respirator systems can be used in a variety of workplace applications. They include powered air respirators with integrated head, eye, face and respiratory protection and supplied air regulators with half and full face masks.

Selection Process for Modular Systems

Powered Air Systems

Stage 1A
Select Powered Air Turbo*

Stage 1B
Select Filters, Battery and Belt



Stage 2
Select your Headtop



Stage 3
Select your Breathing Tube



Stage 4
Choose Accessories



* Want an even easier way to select a system? Choose 3M's powered air starter kits, which include everything apart from the headtop.

Supplied Air Systems

Stage 1
Select your Regulator



Stage 2
Select your Headtop



Stage 3
Select your Breathing Tube



Stage 4
Select your Compressed Air Supply Tube



Stage 5
Select Couplings



Stage 6
Choose Accessories



3M™ Powered and Supplied Air Respirators

Modular Respirator Systems

3M™ Versaflo™ Headcovers and Hoods S-Series

Integrated Suspension Reusable Suspension

S-133 S/L
S-333G S/L

S-433 S/L
S-533 S/L

S-655
S-657
S-757

S-855E

3M™ Versaflo™ Headtops M-Series

Faceshields Helmets Helmets with Shrouds

M-206
M-207

M-306
M-307

M-406
M-407

Breathing Tubes

BT-20 S/L: Lightweight (in two lengths)
BT-30: Self-adjusting
BT-40: Heavy-duty rubber

BT-20 S/L

BT-30*

BT-40

* BT-30 not approved for use with M-400 Headtop/TR-600 Powered Air Turbo combinations. BT-20S/L or BT-40 Breathing Tube should be used.

Powered Air Turbos

Particulate only (nuisance level organic vapour and acid gas options available) Particulate + Gas and Vapour Particulate + Gas and Vapour Particulate + Gas and Vapour Intrinsically Safe Particulate + Gas and Vapour

3M™ Versaflo™ Powered Air Turbo TR-300+

3M™ Versaflo™ Powered Air Turbo TR-600

3M™ Versaflo™ Powered Air Turbo TR-800

3M™ Jupiter™ Powered Air Turbo

3M™ Jupiter™ Powered Air Turbo with IS Kit

Filter

- Spark Arrestor
- Prefilter
- P Filter
- P/Nuisance Level Organic Filter
- P/Nuisance Level Acid Gas (HF up to 10 x Threshold Limit Value)

Battery

- Standard battery
- High capacity battery

Charger

- Single Station Battery Charger
- 4-Station Battery Charger Kit

Filter

- Spark Arrestor
- Prefilter
- P Filter
- P/Nuisance Level Organic Vapour/Acid Gas
- A1P Filter
- A2P Filter
- ABE1P Filter
- ABE2K1HgP Filter

Battery

- Standard Battery
- High Capacity Battery

Charger

- Single Station Bat. Charger
- 4-Station Bat. Charger Kit

Filter

- Prefilter Pads
- Particulate P Filters
- A2P Filters
- A2BEK1P Filters
- ABE1P Filters

Battery

- 4 hour Battery
- 8 hour Battery
- 4 hour IS Battery

Charger

- Single Station Battery Charger
- 10-station Multi Battery Charger

3M™ Powered and Supplied Air Respirators



Breathing Tube Accessories

BT-922: Disposable Cover
 BT-926: Flame-resistant Cover
 BT-927: Radiant Heat Cover

Supplied Air Regulators

Air Cooling



3M™ Versaflo™
 Supplied
 Air Unit V-100E

Air Heating



3M™ Versaflo™
 Supplied
 Air Unit V-200E

Flow Controlled



3M™ Versaflo™
 Supplied
 Air Regulator V-500E

Belt unit coupling

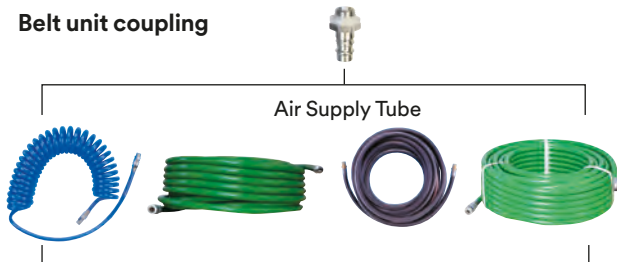

Air supply
 tube coupling set

3M™ Aircare™ Filtration Units
 (Wall Mounted or Freestanding)



Individual Respirator Systems

Mask - Mounted Powered Air Respirator System for Asbestos Environments



3M™ Scott™ Phantom Vision Powered Air Respirator

Supplied Air Respirators



3M™ S-200+
 Supplied Air System



3M™ Scott™
 Promask Combi

Welding Headtops



* For welding applications please refer to the Speedglas™ pages of this catalogue.

3M™ Powered and Supplied Air Respirators

3M™ Scott™ Modular Respirator Systems

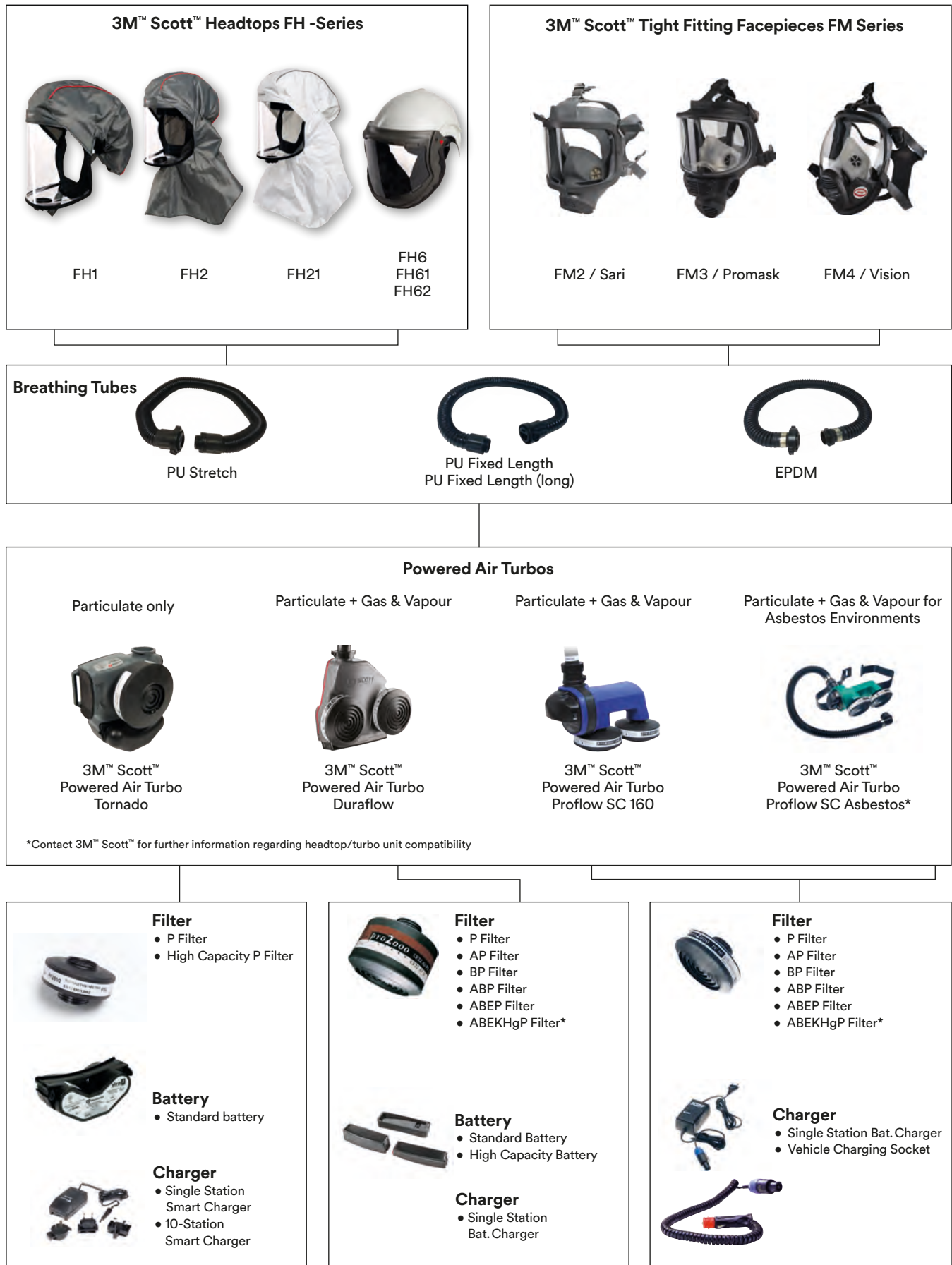

3M™ Versaflo™ Powered Air Turbo TR-800+

Intrinsically Safe (IS) Powered Air Turbo and Battery TR-800 Series are ATEX Certified for use in potentially explosive atmospheres whilst offering the comfort, modularity, control and ease of use expected from the 3M™ Versaflo™ platform.

Typical Applications

- Pharmaceutical manufacturing
- Oil & Gas refining
- Automotive and industrial paint spraying
- Transportation
- Food production
- Chemical handling

Features and Benefits:

Comfortable airflow

- Three user selectable flow rates to maximise comfort
- Controlled airflow delivers steady flow as battery discharges or filter loads with particulates

Ease of use

- IS TR-800 Series display shows battery charge status and particulate filter loading status during use
- Battery charge indicator
- Charge status is also indicated by a useful LED display on the battery
- No user calibration of turbo required
- Electronic audible and visual alarm in case of low battery and/or low air flow

Easy identification

- Bright yellow touchpoints to differentiate from non-IS versions of Versaflo Product Family

Secure battery attachment

- Approved to EN 12941, TH2 or TH3 depending on headtop
- Mechanical attachment of battery to help prevent battery removal and spark risk during use per EN 60079-11

Battery protection

- Battery features bumpers to help absorb impacts



Filter	Filter Covers
TR-6710E P	TR-6700FC
TR-6820E P + Nuisance Odour* Organic Vapour Filter and Acid Gas (Hydrogen Fluoride up to 10 x Threshold Limit Value)	TR-6800FC
TR-6110E A1P TR-6130E ABE1P	TR-6100FC
TR-6310E A2P	TR-6300FC
TR-6580E ABE2K1HgP	TR-6500FC

* "Nuisance Odour" refers to concentrations below the occupational exposure limit (OEL)

Batteries

TR-830 Intrinsically Safe Battery

Belts

TR-626 High Durability Belt TR-627 Easy Clean Belt

Spares & Accessories

TR-838 Battery Attachment Tool	TR-838 Battery Attachment Tool
TR-971 Airflow Indicator	TR-653 Cleaning and Storage Kit
TR-329 Braces	BPK-01 Backpack
TR-6600 Pre-filter	TR-662 Spark Arrestor

Chargers

TR-641E Single Station Battery Charger Kit
TR-644E 4-Station Battery Charger Kit

3M™ Versaflo™ Powered Air Turbo TR-802E

This unit comes with an airflow indicator only. To adapt to your type of environment see options below.

3M™ Versaflo™ Starter Kit TR-819E+

This 3M™ Versaflo™ Starter Kit includes the TR-802E+ Turbo, particulate filter, pre-filter, easy clean belt, intrinsically safe battery pack, battery charger kit, self-adjusting breathing tube and airflow indicator.



3M™ Modular Respirator Systems

3M™ Versaflo™ Powered Air Turbo TR-600

3M Versaflo Powered Air Respirator System TR-600 provides protection against particles, gases or vapours, or against a combination of these depending on the type of filter used.

The turbo has selectable multiple airflows through a simple, intuitive, easy to use two-button operation and the particulate filter and battery status indicators provide constant updates during use. The modern, low profile design keeps weight close to the back resulting in greater comfort.

Features and Benefits:

Comfortable Airflow

- Three user selectable flow rates to maximise comfort
- Controlled airflow delivers steady flow as battery discharges or filter loads with particulates

Ease of Use

- TR-600 display shows battery charge status and particulate filter loading status during use
- Charge status is also indicated by a useful LED display on the battery
- No user calibration of turbo required
- Electronic audible, visual and vibratory alarm in case of low battery and/or low air flow

Multiple Applications

- Easy clean belt – submersible belt with smooth surfaces allows easy, thorough cleaning
- High durability belt option for hot work or rugged environments provides greater durability and spark/flame resistance
- Suitable for shower decontamination and temporary submersion to aid cleaning
- For asbestos specific version, please see Individual Respirator Systems - TR-603E-ASB

Safety

- Approved to EN 12941 Class TH2 or TH3 dependent on headtop

Filter	Filter Covers
TR-6710E P	TR-6700FC
TR-6820E P + Nuisance Odour* Organic Vapour Filter and Acid Gas (Hydrogen Fluoride up to 10 x Threshold Limit Value)	TR-6800FC
TR-6110E A1P TR-6130E ABE1P	TR-6100FC
TR-6310E A2P	TR-6300FC
TR-6580E ABE2K1HgP	TR-6500FC

* "Nuisance Odour" refers to concentrations below the occupational exposure limit (OEL)



Typical Applications

- Pharmaceutical manufacturing
- Painting
- Chemical processing
- Agriculture
- Demolition
- Pulp and paper processing
- Medical & healthcare
- Foundries

3M™ Versaflo™ Powered Air Turbo TR-602E

This turbo can be easily adapted to your type of environment - see options below. (Includes Air Flow Indicator TR-971 and Spark Arrestor TR-662 x2).



3M™ Versaflo™ Powered Air Turbo Starter Kit TR-619E

This Versaflo™ Starter Kit includes the TR-602E Turbo, A2P filter, filter cover, prefilters (x10), spark arrestors (x2), easy clean belt, high capacity battery, single station battery charger kit, BT-30 length adjusting breathing tube and airflow indicator.



Batteries

TR-630 Standard Battery TR-632 High Capacity Battery

Belts

TR-626 High Durability Belt TR-627 Easy Clean Belt

Spares & Accessories

TR-6600 Pre-filter TR-971 Air Flow Indicator

TR-662 Spark Arrestor BPK-01 Backpack

TR-653 Cleaning & Storage Kit TR-655 Backpack Adapter

TR-651 Filter Latch Assembly TR-329 Braces

TR-627X Easy Clean Belt Extender

Chargers

TR-641E Single Station Battery Charger Kit

TR-644E 4-Station Battery Charger Kit



3M™ Modular Respirator Systems

3M™ Versaflo™ Powered Air Turbo TR-300+

3M™ Versaflo™ Powered Respirator System TR-300+ combines performance, protection and functionality with modern, stylish design and comfort. It is the key to easy-to-use, versatile, respiratory protection systems for particulate environments.

Typical Applications

- Pharmaceutical manufacturing
- Woodworking
- Surface preparation
- Food & beverage
- Metal working
- Smelting

Features and Benefits:

Ease of use

- Battery charge status, selected airflow and particulate filter loading status indicators
- Electronic audible and visual alarm in case of low battery and/or low air flow
- Charge status is indicated by a useful LED display

Comfort

- 185 l/min and 205 l/min airflow rate options for user comfort
- Light and small - slim, lightweight, balanced design for comfort

Multiple applications

- High efficiency filter captures hazardous dust, mist and fume plus options for nuisance level gases and vapours
- IP53 rating. Suitable for use in decontamination shower
- Leather belt
- Spark arrestor

Safety

- Approved to EN 12941, TH2 or TH3 depending on headtop



Leather Belt TR-326



Spark Arrestor TR-362

3M™ Versaflo™ Powered Air Turbo TR-302E+

This unit comes with an airflow indicator only. To adapt to your type of environment see options below.

3M™ Versaflo™ Starter Kit TR-315E+

This Versaflo Starter Kit includes the TR-302E+ Turbo, particulate filter, pre-filter, spark arrestor, standard belt, high capacity battery pack, battery charger kit, self-adjusting breathing tube and airflow indicator.



Filter

TR-3712E P

TR-3802E P + Nuisance Level* Organic Vapour

TR-3822E P + Nuisance Level* Acid Gas Filter (Hydrogen Fluoride up to 10 x Threshold Limit Value)

* Nuisance level refers to concentrations below the occupational exposure limit (OEL)

Batteries

TR-330 Standard Battery

TR-332 High Capacity Battery

Belts

TR-325 Standard Belt

TR-327 Easy-Clean Belt

TR-326 Leather Belt

Spares & Accessories

TR-3600 Pre-filter

TR-970 Air Flow Indicator

BPK-01 Backpack

TR-362 Spark Arrestor

TR-329 Braces

TR-380 Filter Surround Gasket

Chargers

TR-341E Single Station Battery Charger Kit

TR-344E 4-Station Battery Charger Kit

3M™ Modular Respirator Systems

3M™ Jupiter™ Powered Air Turbo

Fully compatible with all 3M™ Versaflo™ Headtops and Breathing Tubes, the 3M Jupiter Respirator provides respiratory protection against particulate and gaseous contaminants (particulate only and combined particulate/gas and vapour filters are available). It can also be used in potentially explosive atmospheres when fitted with the intrinsically safe pouch and battery (available as the Intrinsically Safe Kit).

Ergonomically designed to sit at the base of the user's back, the unit's low weight is carried mostly on the user's hips via the padded comfort belt. As a result, the 3M Jupiter Respirator is comfortable enough to wear for entire work shifts.

Features and Benefits:

Ease of Use

- Electronic audible and visual alarm in case of low battery and/or low air flow

Comfort

- Modern, ergonomic design
- High comfort decontamination belt

Multiple Applications

- IP53 rating. Suitable for shower decontamination
- "Intrinsically Safe" (IS) Kit is available for use in potentially explosive atmospheres. Kit includes pouch and Intrinsically Safe battery

Safety

- Approved to EN 12941 class TH2 or TH3 depending on headtop



Typical Applications

- Pharmaceutical manufacturing
- Demolition
- Painting
- Pulp and paper processing
- Chemical processing
- Medical & healthcare
- Agriculture
- Foundries

3M™ Jupiter™ Turbo (085-00-10P)

Includes decontamination belt, air flow indicator and calibration tube.

To adapt to your type of environment see options below.

3M™ Jupiter™

Powered Air Starter Kit

This Starter Kit includes a standard Jupiter Turbo with decontamination belt and clip, air flow indicator and calibration tube as well as a pair of organic vapour and particulate (A2P) filters, pre-filters, self-adjusting breathing tube, 8 hour rechargeable battery (NiMH) and battery charger.



Now choose your headtop



Filter

Pre-filter Pack	461-00-02P24X5
P Filter	450-00-25P2X12
A2P Filter	453-00-25P2X6
ABE1P Filter	456-18-25P2X6
A2BEK1P Filter	453-09-25P2X6

Batteries

Battery Pack - 8 hour	007-00-64P
Battery Pack - 4 hour	007-00-63P
Battery Pack - 4 hour IS battery (provided as part of IS Kit with pouch).	085-12-00P

Chargers

Intelligent Charger	CHG-02EU
10 Station Intelligent Charger	CHG-04

3M™ Modular Respirator Systems

3M™ Versaflo™ Supplied Air System V-Series

The modular range of supplied air respirators lets you choose how you want your system built, with the flexibility to change it in the future. The 3M™ Versaflo™ Supplied Air Regulators offer protection against dust, mist, fumes, gases or vapours and combination hazards e.g. paint spray. Supplied Air Regulators do not offer protection in confined spaces, oxygen deficient atmospheres or for asbestos stripping.

Typical Applications

- Surface preparation, painting and coating
- Metalworking
- Agriculture
- Woodworking

Features and Benefits:

Comfort

- Individually adjustable, consistently controlled airflow
- Air flow 170-305 l/min
- Removable, integrated activated charcoal filter
- Integrated silencer
- Belt swivel mechanism

Multiple Applications

- Spray gun or compressed air-tool port

Safety

- Low-pressure warning whistle
- Double action supplied air connection
- Approved to EN 14594 Class 2A/3A or 2B/3B dependent on headtop



3M™ Versaflo™ Supplied Air Regulator V-500E

Balanced regulator specifically designed for respirator use, the Versaflo V-500E Regulator ensures smooth airflow, safety and comfort.

3M™ Versaflo™ Cooling Regulator V-100E and 3M™ Versaflo™ Heating Regulator V-200E

3M™ Versaflo™ Regulators V-100E and V-200E allow users to either cool (V-100E) or heat (V-200E) the air by as much as 28°C, making them a good choice for workers exposed to uncomfortably hot or cold temperatures.



Now choose your headtop



Filtration Units and Couplings

The 3M™ Aircare™ Filtration Unit can be connected inline to clean the compressed air before it is fed to the regulator.

The various components of the Versaflo V-Series Regulators are connected using plug and socket hose couplings (Rectus 25 or Rectus 95 connectors available).

3M™ Modular Respirator Systems

3M™ Versaflo™ Integrated Suspension Headcovers & Hoods S-Series

Based on a computer modeling of a worldwide sampling of head sizes, the 3M™ Versaflo™ Headcovers and Hoods S-Series, through their sizing and adjustment options, will comfortably fit many users. The integrated suspension headcovers and hoods can be suitable for applications that require frequent replacement of the entire headtop assembly, such as pharmaceutical manufacturing, or in situations where there is less soiling of the outer fabric. For disposal, the suspension assembly and air inlet components can be quickly removed and separated for segregated waste streams, where facilities are available.

Typical Applications

- Surface preparation, painting and coating
- Pharmaceutical manufacturing
- Chemical industry
- Medical and healthcare
- Food and beverage
- Agriculture
- Woodworking
- Pulp and paper processing

Features and Benefits:

All-Day Comfort

- Slim design, that closely profiles the user's head for improved appearance
- Lightweight and loose-fitting
- Excellent airflow distribution for improved comfort, lower noise and reduced fogging

Integrated Suspension

- Ready to use straight out of the box
- Available in two adjustable sizes: S/M (50-58 cm) and M/L (54-64 cm)

Improved Visibility

- Excellent field of view, particularly downwards, with reduced curvature for decreased reflections and glare

Added Protection

- Comfortably worn with prescription eyewear, safety glasses, and some limited facial hair
- Meets the highest respiratory performance requirements (TH3) for this type of product when used with 3M™ Air Delivery Unit
- Eye and face protection to EN166 – liquid splash and low energy impact
- Coverage of head, hair, neck and shoulders



3M™ Versaflo™ Hood S-533

Neck and shoulder coverage with soft, low-linting fabric that more readily drapes over user.

Fabric material: Polyurethane coated knitted polyamide.

Visor material: Coated polycarbonate for increased chemical and scratch resistance.



3M™ Versaflo™ Headcover S-133

General purpose, cost-effective fabric.

Fabric material: 2-layer polypropylene spunbond/laminated film.

Visor material: PETG.



3M™ Versaflo™ Headcover S-333G

Soft, quiet, more durable low-linting fabric.

Fabric material: Polyurethane coated knitted polyamide.

Visor material: Coated polycarbonate for increased chemical and scratch resistance.



3M™ Versaflo™ Hood S-433

Includes neck and shoulder coverage.

Fabric material: 2-layer polypropylene spunbond/laminated film.

Visor material: PETG.

3M Air Delivery Unit

S-Series Headcovers and Hoods

Additional Protection

Classification

NPF¹

Eye Protection EN 166 2:F:3

3M™ Versaflo™ TR-300+	EN 12941 TH3	500
3M™ Versaflo™ TR-600	EN 12941 TH3	500
3M™ Jupiter™	EN 12941 TH3	500
3M™ Versaflo™ V-100E/ V-200E/V-500E	EN 14594 3A ²	200

1 Nominal Protection Factor (NPF) - a number derived from the maximum percentage of total inward leakage permitted in relevant European Standards for a given class of respiratory protective devices.

2 S-Series Headcovers and Hoods meet the lower strength (A) requirements of EN14594. They are approved for use with a range of compressed air supply tubes that meet both the lower and higher strength (A and B) requirements.

3M™ Modular Respirator Systems

3M™ Versaflo™ Premium Hoods with Reusable Suspensions S-Series

Premium reusable suspension hoods can be a highly cost-effective choice for some high disposal rate environments: just the soiled hood fabric is replaced, while the suspension and air ducting can be reused. It also has an externally-adjustable airflow control that allows wearers to modify the airflow distribution to suit personal comfort needs. With a simple turn of the external controller, wearers can shift the location of air flowing over the back of their head to over their temples, face and visor.

Features and Benefits:

Comfort

- Slim design, that closely profiles the user's head for improved appearance
- Lightweight and loose-fitting
- Excellent airflow distribution for improved comfort, lower noise and reduced fogging

Reusable Suspension

- Cost effective choice for some high disposal rate environments
- User control of airflow location and suspension adjustments for best comfort and custom fit
- One Size: 50-64cm

Improved Visibility

- Excellent field of view, particularly downwards, with reduced curvature for decreased reflections and glare

Added Protection

- Comfortably worn with prescription eyewear, safety glasses, and some limited facial hair
- Meets the highest respiratory performance requirements (TH3) for this type of product when used with 3M™ Air Delivery Units
- Eye and face protection EN166 – liquid splash and low energy impact



3M Air Delivery Unit	S-Series Headcovers and Hoods	Additional Protection
	Classification	NPF ¹
3M™ Versaflo™ TR-300+	EN 12941 TH3	500
3M™ Versaflo™ TR-600	EN 12941 TH3	500
3M™ Jupiter™	EN 12941 TH3	500
3M™ Versaflo™ V-100E/ V-200E/V-500E	EN 14594 3A ²	200

1 Nominal Protection Factor (NPF) - a number derived from the maximum percentage of total inward leakage permitted in relevant European Standards for a given class of respiratory protective devices.
2 S-Series Headcovers and Hoods meet the lower strength (A) requirements of EN14594. They are approved for use with a range of compressed air supply tubes that meet both the lower and higher strength (A and B) requirements.

Typical Applications

- Surface preparation, painting and coating
- Pharmaceutical manufacturing
- Chemical industry
- Medical and healthcare
- Food and beverage
- Agriculture
- Woodworking
- Pulp and paper processing



reddot design award
honourable mention 2011

3M™ Versaflo™ Hood S-655

General purpose, with knitted inner collar that is shorter and thinner than previous models.

Fabric material: 2-layer polypropylene spunbond/laminated film.

Visor material: PETG.



3M™ Versaflo™ Hood S-657

Features a double-shroud design for its respiratory seal. The inner shroud can be tucked into a shirt or protective coverall, which allows excess air to be channeled over the body, providing additional comfort.

Fabric material: 2-layer polypropylene spunbond/laminated film.

Visor material: PETG.



3M™ Versaflo™

Painters Hood S-757

Fabric specifically intended to help capture paint overspray. Double shroud design.

Fabric material: 3-layer polypropylene spunbond/laminated film/spunbond.

Visor material: Coated polycarbonate.



3M™ Versaflo™ Hood S-855E

Sealed seam hood for liquid chemical splash environments. Knitted inner collar design.

Fabric material: Spunbond polypropylene with multilayer barrier film.

Visor material: Coated polycarbonate.

3M™ Modular Respirator Systems

3M™ Versaflo™ Faceshields M-200 Series

The 3M™ Versaflo™ Headtops M-200 Series feature lightweight, compact and well-balanced faceshields that can offer integrated protection from a range of respiratory, head, eye, face and hearing hazards.

Features and Benefits:

Highly Versatile Rigid Headtops

- Provides protection from specific respiratory, head and eye hazards
- Bump cap protection approved according to EN812

Modern, Well Balanced Design

- Lightweight with excellent balance
- Fully-adjustable head suspension
- A deflector allows users to direct the airflow inside the headtop for increased control and comfort

Visor Design

- Visor design combines excellent peripheral and downward vision with good optical clarity
- Lenses provide chemical and scratch resistance

Easy To Maintain

- Many parts are common to all Versaflo M-Series Headtops, meaning reduced inventories and downtime
- Spare parts and accessories are quick, easy and intuitive to replace



Typical Applications

- Woodworking
- Grinding
- Painting
- Polishing
- Surface treatment
- Agricultural applications

3M™ Versaflo™ Faceshield M-206

Features a general purpose faceseal for dusts, spraying and chemical processing.

Fabric material: Polyurethane coated polyamide.

3M™ Versaflo™ Faceshield M-207

Features a flame resistant faceseal for applications with hot particles.

Fabric material: Flame resistant polyester.

Accessories

M-925 Uncoated Visor - providing additional molten metal splash protection

M-927 Coated Visor - providing chemical and scratch resistance

M-928 Peel-Off Visor Covers (pack of 10)

M-935 Standard faceseal (white) (pack of 5)

M-936 Comfort faceseal (pack of 5)

M-937 Flame resistant faceseal (pack of 5)

M-958 Chin-strap

M-972 Flame Resistant Headtop Cover

M-976 Head, Neck and Shoulder Cover



3M Air Delivery Unit

Versaflo™ M-200

	Classification	NPF ¹
3M™ Versaflo™ TR-300+	EN12941 TH3	500
3M™ Versaflo™ TR-600	EN12941 TH3	500
3M™ Jupiter™	EN12941 TH2	50
3M™ Versaflo™ V-100E/ V-200E/V-500E	EN14594 3B ²	200

Additional Protection

Eye Protection EN166 1:BT:3*
EN166 1:BT:3:9**

Head Protection EN812

* With M-927 Coated Visor

** With M-925 Uncoated Visor

¹ Nominal Protection Factor – a number derived from the maximum percentage of total inward leakage permitted in relevant European Standards for a given class of respiratory protective devices.

² The M-Series Faceshields and Helmets meet the higher strength (B) requirements of EN14594. They are approved for use with a range of compressed air supply tubes that meet both the lower and higher strength (A and B) requirements.

3M™ Modular Respirator Systems

3M™ Versaflo™ Helmets M-300 Series

The 3M™ Versaflo™ Helmets M-300 Series feature lightweight, compact and well-balanced helmets that can offer integrated protection from a range of respiratory, head, eye, face and hearing hazards. M-300 Series helmets meet the highest respirator performance requirements (TH3) for this type of product when used with specific 3M™ Air Delivery Units.

Features and Benefits:

Highly Versatile Rigid Headtops

- Head protection approved according to EN397
- Integrated protection from multiple hazards (e.g. respiratory, impact, splash hazards)

Modern, Well Balanced Design

- Lightweight with excellent balance
- Fully-adjustable head suspension
- A deflector allows users to direct the airflow inside the headtop for increased control and comfort

Visor Design

- Visor design combines excellent peripheral and downward vision with good optical clarity
- Lenses provide chemical and scratch resistance

Easy To Maintain

- Optional hearing protection 3M™ PELTOR™ Helmet-Mounted Earmuff Assembly
- Many parts are common to all Versaflo M-Series Headtops, meaning reduced inventories and downtime
- Spare parts and accessories are quick, easy and intuitive to replace



3M Air Delivery Unit	Versaflo™ M-300 Classification	NPF ¹
3M™ Versaflo™ TR-300+	EN12941 TH3	500
3M™ Versaflo™ TR-600	EN12941 TH3	500
3M™ Jupiter™	EN12941 TH2	50
3M™ Versaflo™ V-100E/ V-200E/V-500E	EN14594 3B ²	200

1 Nominal Protection Factor – a number derived from the maximum percentage of total inward leakage permitted in relevant European Standards for a given class of respiratory protective devices.

2 The M-Series Faceshields and Helmets meet the higher strength (B) requirements of EN14594. They are approved for use with a range of compressed air supply tubes that meet both the lower and higher strength (A and B) requirements.

Additional Protection
Eye Protection EN166 1:BT:3* EN166 1:BT:3:9**
Hearing Protection EN352-3***
Head Protection EN397 LD 440V a.c.

* With M-927 Coated Visor
 ** With M-925 Uncoated Visor
 *** With 3M™ PELTOR H31 P3AF 300 SNR = 28 Size designation M/L; Optime I SNR = 26 Size designation M/L; Optime II SNR = 30 Size designation M/L; Optime III SNR = 34 Size designation M/L; X1P5/X1P5-OR SNR = 26dB Size Designation SML; X2P5 SNR = 30 Size Designation ML; X3P5 SNR = 32 Size Designation ML; X4P5/ X4P5-OR SNR = 32 Size Designation SML or X5P5 SNR = 36 Size Designation L.
 Contact 3M for full attenuation data including octave band and H, M and L values.

Typical Applications

- Smelting and foundry applications
- Grinding
- Chemical processing and plant maintenance
- Agricultural applications
- Construction and renovation
- Demolition



reddot design award
honourable mention 2011



INTERNATIONAL DESIGN
EXCELLENCE AWARDS '11
BRONZE

3M™ Versaflo™ Helmet M-306

Features a general purpose faceseal for construction, chemical applications and heavy industry.

Fabric material: Polyurethane coated polyamide.

3M™ Versaflo™ Helmet M-307

Features a flame resistant faceseal for applications with hot particles.

Fabric material: Flame resistant polyester.

Accessories

M-925 Visor - providing additional molten metal splash protection

M-927 Coated Visor - providing chemical and scratch resistance

M-928 Peel-Off Visor Covers (pack of 10)

M-935 Standard faceseal (white) (pack of 5)

M-936 Comfort faceseal (pack of 5)

M-937 Flame resistant faceseal (pack of 5)

M-958 Chin-strap

H31P3AF 300, H510P3AF-405-GU (Optime I), H520P3AF-410-GQ (Optime II), H540P3AF-413-SV (Optime III),

The following may also be used in combination with the Z3AF/2 adaptor:
 X1P5/X1P5-OR, X2P5, X3P5, X4P5/X4P5-OR, X5P5

M-972 Flame Resistant Headtop Cover

M-976 Head, Neck and Shoulder Cover



3M™ Modular Respirator Systems

3M™ Versaflo™ Helmet M-300 with integrated communications and hearing protection

M-300 Series Helmets meet the highest powered respirator performance requirements (TH3) for this type of product when used with specific 3M™ Air Delivery Units. Now approved to be used with 3M™ PELTOR™ LiteCom headsets, M-300 Helmets offer you the possibility to communicate effectively whilst protecting your hearing in noisy environments.

Typical Applications

- Smelting and foundry applications
- Grinding
- Chemical processing and plant maintenance
- Agricultural applications
- Construction and renovation
- Demolition

Features and Benefits:

Highly versatile rigid headtops

- Head protection approved according to EN397
- Integrated protection from multiple hazards (e.g. respiratory, impact, splash hazards)

Modern, well balanced design

- Lightweight with excellent balance
- Fully-adjustable head suspension
- A deflector allows users to direct the airflow inside the headtop for increased control and comfort

Visor design

- Visor design combines excellent peripheral and downward vision with good optical clarity
- Lenses provide chemical and scratch resistance



2 options of built-in microphones

- Dynamic
- Electret

3 options of LiteCom headsets

• 3M™ PELTOR™ LiteCom



Two way radio

• 3M PELTOR™ LiteCom Plus



Two way radio



External audio input



Level dependent function for ambient listening

• 3M™ PELTOR™ WS™ LiteCom



Two way radio



External audio input



Level dependent function for ambient listening



Bluetooth® connectivity

Product references

M-307	3M™ Versaflo™ Helmet M-307 with flame resistant face seal
MT7V/1	Dynamic Microphone (including helmet attachment)
MT53V/1	Electret Microphone (including helmet attachment)
MT7H7P3E4410-EU	3M™ PELTOR™ LiteCom Plus, PMR 446, helmet attachment, dynamic mic
MT7H7P3E4310-EU	3M™ PELTOR™ LiteCom Plus, LPD 433, helmet attachment, dynamic mic
MT53H7P3E4410WSS	3M™ PELTOR™ WS™ LiteCom, PMR 446, helmet attachment, electret mic
MT53H7P3E4400-EU	3M™ PELTOR™ LiteCom, PMR 446, helmet attachment, electret mic

Approvals

Respiratory protection EN12941 TH2/TH3 EN14594 3B*
Hearing protection PPE Directive (89/686/EEC) RED Directive (2014/53/EU) EMC Directive (2014/30/EU) LVD Directive (2014/35/EU) ROHS Directive (2011/65/EU)
Head protection EN397 LD 440V a.c.
Eye protection EN166 1:BT:3** EN166 1:BT:3:9***

* The M-Series Helmets meet the higher strength (B) requirements of EN14594. They are approved for use with a range of compressed air supply tubes that meet both the lower and higher strength (A and B) requirements.

** With M-927 Coated Visor
*** With M-925 Uncoated Visor

3M™ Modular Respirator Systems

3M™ Versaflo™ Helmets with Shrouds M-400 Series

The 3M™ Versaflo™ M-Series Helmets can offer integrated protection from a range of respiratory, head, eye, face and hearing hazards with additional neck and shoulder coverage. M-400 Series helmets meet the highest respirator performance requirements (TH3) for this type of product when used with specific 3M™ Air Delivery Units.

Typical Applications

- Smelting & foundry applications
- Grinding
- Construction & renovation
- Demolition



reddot design award
honourable mention 2011



Features and Benefits:

Highly Versatile Rigid Headtops

- Head protection approved according to EN397
- Integrated protection from multiple hazards (e.g. respiratory, impact, splash hazards)

Modern, Well Balanced Design

- Lightweight with excellent balance
- Fully-adjustable head suspension
- A deflector allows users to direct the airflow inside the headtop for increased control and comfort

Visor Design

- Visor design combines excellent peripheral and downward vision with good optical clarity
- Lenses provide chemical and scratch resistance

Easy To Maintain

- Many parts are common to all Versaflo M-Series Headtops, meaning reduced inventories and downtime
- Spare parts and accessories are quick, easy and intuitive to replace



3M™ Versaflo™ Helmet M-406

Features a highly durable shroud for construction applications and heavy industry.

Fabric material: Nylon.

3M™ Versaflo™ Helmet M-407

Features a flame resistant shroud for applications with hot particles.

Fabric material: Polyaramid.

Accessories

M-925 Visor - providing additional molten metal splash protection

M-927 Coated Visor - providing chemical and scratch resistance

M-928 Peel-Off Visor Covers (pack of 10)

M-958 Chin-strap

M-447 Flame resistant shroud

M-448 High durability shroud

M-972 Flame resistant headtop cover

3M Air Delivery Unit	Versaflo™ M-400	
	Classification	NPF ¹
3M™ Versaflo™ TR-300+	EN12941 TH3	500
3M™ Versaflo™ TR-600	EN12941 TH3	500
3M™ Jupiter™	EN12941 TH3	500
3M™ Versaflo™ V-100E/ V-200E/V-500E	EN14594 3B ²	200

Additional Protection

Eye Protection EN166 1:BT:3*
EN166 1:BT:3:9**

Hearing Protection N/A

Head Protection EN397 LD 440V a.c.

* With M-927 Coated Visor

** With M-925 Uncoated Visor

1 Nominal Protection Factor – a number derived from the maximum percentage of total inward leakage permitted in relevant European Standards for a given class of respiratory protective devices.

2 The M-Series Faceshields and Helmets meet the higher strength (B) requirements of EN14594. They are approved for use with a range of compressed air supply tubes that meet both the lower and higher strength (A and B) requirements.



3M™ Modular Respirator Systems

3M™ Radiant Heat Cover M-973/M-975 and Over-Visor M-967

The 3M™ Radiant Heat Covers M-973/M-975 when used in combination with the 3M™ M-967 Over-Visor offers 360° coverage of the 3M™ Versaflo™ M-307/M-407 Respirator helmet. Protection in accordance with EN ISO 11612:2015, EN 166:2001, EN 170:2002 and EN 171:2002 is offered against radiant heat and sparks/splashes for all parts of the helmet.

Typical Applications

- Furnaces and smelting
- Foundry casting

Features and benefits:

- Designed to be robust and durable to withstand some of the harsh environments experienced in the metal production industry
- Adaptable - the radiant heat cover and over-visor comprises modular components allowing the user to select the components required to adapt to their needs
- Low profile, designed specifically for 3M™ M-307/M-407 Respirator Helmet
- The over-visors are designed to be flip-up, allowing the user the flexibility to have shaded IR/UV protection when needed but have the peace of mind of clear vision when not required
- Utilises the 3M™ Visor Carrier M-961 to fit to the 3M™ M-307/M-407 Respirator helmet
- Additional option: 3M™ Radiant Heat Breathing Tube Cover BT-927



M-307 with M-973 Radiant Heat Kit and M-967 Over Visor



M-407 with M-975 Radiant Heat Kit and M-967 Over Visor



3M™ Over-Visor M-967



3M™ Visor Carrier M-961



3M™ Radiant Heat Cover M-973 for 3M™ Helmet M-307



3M™ Radiant Heat Cover M-975 for 3M™ Helmet M-407



3M™ Versaflo™ Breathing Tube Cover BT-927

Radiant heat cover performance

EN ISO 11612 Code letter and classification Heat transmission performance requirement

A1	Limited flame spread
B1	Convective heat
C4	Radiant heat
D3	Molten aluminium splash
E3	Molten iron splash

Over-visor and visor carrier performance

Model	European standard	Scale number	Optical class	Symbol	Field of use	Mechanical strength
M-967 Over-visor	EN 166:2001	2-5 (Ultraviolet)	1	BT	High speed particles	Medium energy impact at extremes of temperature
			9		Molten metal splash	
			4-5 (Infrared)			
M-961 Visor Carrier	EN 166:2001			BT	High speed particles	Medium energy impact at extremes of temperature

Radiant heat covers

3M™ Radiant Heat Cover M-973 for 3M™ M-307 Helmet

3M™ Radiant Heat Cover M-975 for 3M™ M-407 Helmet

Visors

3M™ Visor Carrier M-961

3M™ Over-Visor M-967

Other accessories

3M™ Breathing Tube Cover BT-927

3M™ Modular Respirator Systems

3M™ Versaflo™ Breathing Tubes BT-Series

A breathing tube connecting the air source with the headtop is required to ensure that clean air reaches the headtop reliably and with unrestricted airflow. The breathing tubes offered are compatible with all 3M™ Versaflo™ Headtops and Air Delivery Units*.

Features and Benefits:

- QRS (Quick Release Swivel) breathing tubes allow fast and easy connection
- All BT-Series Breathing Tubes meet the higher respiratory performance requirements with 3M™ headtops
- A special flame-resistant sleeve lengthens the life of the breathing tube and protects it from flying sparks
- A disposable breathing tube cover is available to help aid, cleaning and decontamination



Accessories

BT-922: Disposable breathing tube cover

BT-926: Flame resistant breathing tube cover

BT-927: Radiant Heat Cover



3M™ Versaflo™ Breathing Tube BT-20 S/L
Lightweight breathing tube that comes in two lengths and is easy to wipe down.
Material: Polyurethane.
Length: 735mm (S), 965mm (L).



3M™ Versaflo™ Breathing Tube BT-30
Self-adjusting length for improved fit for many wearers and reduce risk of catching and snagging.
Material: Polyurethane.
Length: 525 - 850mm.



3M™ Versaflo™ Breathing Tube BT-40
High durability breathing tube.
Material: Chloroprene.
Length: 840mm.

* BT-30 not approved for use with M-400 Headtop/TR-600 Powered Air Turbo combinations. BT-20S/L or BT-40 Breathing Tube should be used.

3M™ Modular Respirator Systems

3M™ Compressed Air Supply Tubes and Couplings

Various compressed air supply tubes are available to connect the 3M™ Air Regulator to the facility's compressed air system to meet different requirements.

The tubes are available in different lengths and they guarantee high quality connections to all components. The tubes have a 3/8" male pipe thread BSP at each end to allow flexibility in the choice of coupling systems.

Features and Benefits:

- 3/8" BSP connection
- Flexibility of the hose

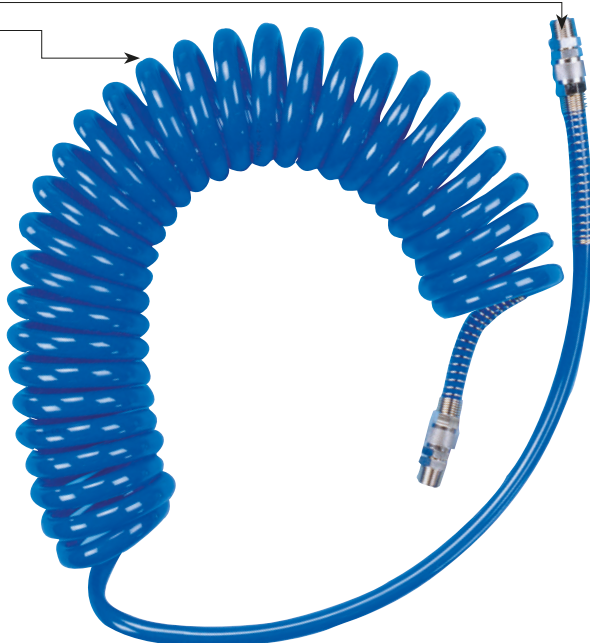

7.5m

Coiled Air Hose

Output 3/8" (both ends).
Part no. 308-00-40P.



10m

Standard duty hose

Output 3/8" (both ends).
Part no. 308-00-30P.



10m

Standard duty

Antistatic, high temperature tube.
Output 3/8" (both ends).
Part no. 308-00-72P.



30m

Standard duty hose

Output 3/8" (both ends).
Part no. 308-00-31P.



Coupling Set 3/8" BSP

Rectus 25
Part no. 530-12-82P3.
Rectus 95
Part no. 530-12-81P3.



2-Way Branch Set
3/8" female pipe thread BSP,
incl. 3/8" BSP adapters
Part no. 312-03-01P3.



3-Way Branch Set
3/8" BSP,
incl. 3/8" BSP adapters
Part no. 312-03-00P3.



Coupling Plug
1/4" BSP,
Rectus 25
Part no. 530-12-52P3.
Rectus 95
Part no. 530-12-53P3.

3M™ Modular Respirator Systems

3M™ Aircare™ Filtration Units

The 3M™ Aircare™ Filtration Units can be combined with all 3M™ Supplied Air Respirator Systems. The three-stage filtration system supplies highest quality air to the Supplied Air Respirator System and compressed air tools by removing water and oil aerosols, particles and odours from the facility-supplied compressed air.

The Filtration Unit is available as either a portable freestanding unit or wall-mounted unit.

Features and Benefits:

- Can be used for up to three users (or two users plus air tool)
- Differential Pressure Indicator
- Pressure regulator (lockable)
- Pressure gauge
- Pre-filter
- Semi Auto Drains (Stage 1, 2) and Manual Drain (Stage 3)
- Coalescing filter
- Adsorber filter with activated charcoal

Adapters and connectors

- Input: 1/2" or 3/8" female pipe thread BSP
- Includes 3/8" to 1/2" BSP adapter
- Includes 2 adapters, 3/8" BSP to 3/8" male pipe thread BSP
- Output: 3/8" BSP
- Output pressure can be adjusted with the integrated pressure regulator. The Aircare™ Filtration Units can be used with input pressures up to 10 bar

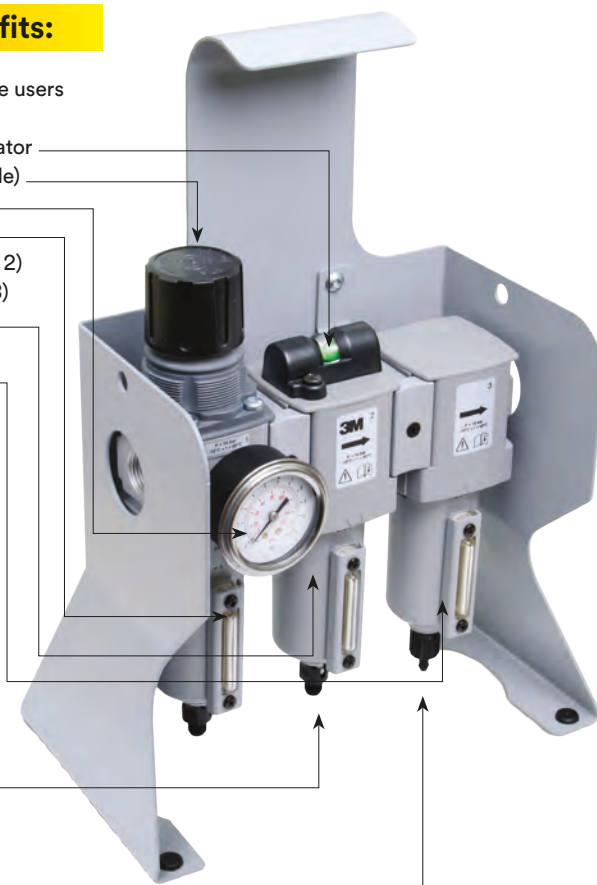

3M™ Aircare™ Filtration Unit, Freestanding ACU-04

Input: 1/2" or 3/8" female pipe thread BSP.
Output: 3/8" BSP.

Wall-mounted option:

3M™ Aircare™ Filtration Unit, Wall Mounted ACU-03

Input: 1/2" or 3/8" female pipe thread BSP.
Output: 3/8" BSP.



3M™ Modular Respirator Systems

3M™ Scott™ Hoods and Headcovers FH Series

The 3M™ Scott™ Headtops FH Series feature lightweight, compact soft hoods and headcovers that can offer protection from a range of respiratory, eye and face hazards when used with compatible 3M™ Scott™ Powered Air Turbos.

Typical Applications

- Surface preparation, painting and coating
- Pharmaceutical manufacturing
- Chemical industry
- Medical and healthcare
- Food and beverage
- Agriculture
- Woodworking
- Pulp and paper processing

Features and Benefits:

Comfort

- Lightweight and loose-fitting
- Excellent airflow distribution for improved comfort, lower noise and reduced fogging
- Soft head cradle for intuitive donning and doffing

Improved Visibility

- Large, flexible PETG visor provides chemical resistance
- Transparent chin panel designed to improve downwards vision

Added Protection

- Comfortably worn with prescription eyewear, safety glasses, and some limited facial hair
- Meets the highest respiratory performance requirements (TH3) for this type of product when used with 3M™ Air Delivery Units
- Eye and face protection EN 166 – liquid splash and low energy impact
- FH51 also provides head protection EN397 for higher risk environments



3M™ Scott™ Headcover FH1

General purpose, with Neoprene chin seal.

Fabric material: PU coated Nylon

Visor material: PETG.



3M™ Scott™ Headtop FH2

Full hood construction can provide limited shoulder coverage, or can be tucked into protective coveralls.

Fabric material: PU coated Nylon

Visor material: PETG.



3M™ Scott Headtop FH21

Anti-static full hood construction can provide limited shoulder coverage, or can be tucked into protective coveralls.

Fabric material: Anti-static PU coated Nylon

Visor material: PETG.



3M™ Scott Headtop FH51

Full hood with helmet and integral visor provides protection in higher risk environments. Made from chemically resistant material with taped seams. Provides EN 397 head protection.

Fabric material: Chemically resistant material
Visor material: PETG.

3M Air Delivery Unit	S-Series Headcovers and Hoods Classification	NPF ¹
3M™ Scott™ Duraflow	EN 12941 TH3	500
3M™ Scott™ Proflow	EN 12941 TH3	500
3M™ Scott™ Tornado	EN 12941 TH3	500

Additional Protection

Eye Protection EN 166 1:F

¹ Nominal Protection Factor (NPF) - a number derived from the maximum percentage of total inward leakage permitted in relevant European Standards for a given class of respiratory protective devices.

3M™ Modular Respirator Systems

3M™ Scott™ Helmet FH6 Series

The 3M™ Scott™ Helmet FH6 s designed for hazardous environments such as cutting, grinding, quarrying, demolition, foundry, construction and ship building. FH6 Series offers combined respiratory, head, face, eye and hearing protection.

Typical Applications

- Cutting
- Grinding
- Demolition
- Quarrying
- Foundry
- Ship building
- Construction

Features and Benefits:

Highly Versatile Rigid Headtops

- Head protection approved according to EN 397
- Integrated protection from multiple hazards (e.g. respiratory, head, face, eye, hearing)

Well Balanced Design

- A parallel monorail system designed to provide easy glide of visor frame
- Up-down visor lift system with sprung suspension wheels designed to provide correct balance on the head
- Compact design for restricted working areas
- Helmet connects to the breathing tube via a swivel-jointed connector designed to improve freedom of movement

Visor Design

- Visor design combines peripheral and downward vision with optical clarity
- Lenses provide chemical and scratch resistance

Easy To Maintain

- Optional hearing protection
- Spare parts and accessories are quick, easy and intuitive to replace



FH6 FT
Featuring clear Polycarbonate lens



FH62 FT
Featuring gold coated Polycarbonate lens

3M Air Delivery Unit	3M™ Scott™ FH6 Series	Additional Protection
	Classification	NPF ¹
3M™ Scott™ Duraflow	EN 12941 TH2	50
3M™ Scott™ Proflow	EN 12941 TH2	50
3M™ Scott™ Tornado	EN 12941 TH2	50
		Eye Protection EN 166 FT
		Head Protection EN 97

¹ Nominal Protection Factor – a number derived from the maximum percentage of total inward leakage permitted in relevant European Standards for a given class of respiratory protective devices.

3M™ Modular Respirator Systems

3M™ Scott™ Duraflow™ Powered Air Turbo

The 3M™ Scott™ Duraflow™ powered air respirator is designed with end user comfort in mind. Its low-profile, modern ergonomic profile allows the user to experience comfort while working in demanding environments.

Typical Applications

- Pharmaceutical manufacturing
- Food and beverage
- Woodworking
- Metal working
- Surface preparation
- Smelting

Features and Benefits:

Robust and lightweight

- Duraflow features a durable body to withstand arduous environments
- The weight of the turbo is approx. 600g (without filters and battery). It also keeps its light weight close to the user's back, reducing the leverage effect that can cause turbos to feel heavier

Controlled airflow

- The turbo unit constantly monitors flowrate in real time to ensure correct flowrate is delivered to the user
- Audible and visual alarms signal if correct flowrate cannot be achieved so user can take appropriate action

Intelligent power

- Standard duration battery provides up to 8 hours autonomy*; an extended duration battery is available for up to 16 hours autonomy*
- Battery charger station allows for an additional battery to be charged whilst the turbo is in operation to minimise downtime

Safety

- Approved to EN 12941, TH2 or TH3 depending on headtop



Versatile Protection

- Compatible with the 3M™ Scott™ Pro2000 Series of filters.



Comfort Belt

3M™ Duraflow™ Powered Air Turbo Kits

3M™ Duraflow™ Starter Kit

This Duraflow Starter Kit includes the Duraflow Turbo, standard belt, standard battery and battery charger.



3M™ Duraflow™ Ready-Paks™

For the ultimate in convenience and for users who do not own an approved compatible headtop, Duraflow Ready-Paks™ are available which comprise the same content as the Starter Kits, with the addition of a compatible headtop and a pair of particulate filters Pro2000 PF10.

A number of headtop configurations are available to best suit the application and the user:

3M™ Duraflow™ with FH1 Ready-Pak™

3M™ Duraflow™ with FH2 Ready-Pak™

3M™ Duraflow™ with FH21 Ready-Pak™

Filter	Protection
PF10 P3 R	P S L
CF22 A2P3 R	A P S L
CF22 B2P3	B P S L
CF22 A2B2P3 R	A B P S L
CF22 A2B2E2 P3 R	A B E P S L
CF32 A2B2E2K2-P3 R	ABEK P S L
CF32 A2B2E2K2 Hg P3 R	ABEK Hg P S L

* Please Note that Hg filters are only approved with the highest Powered Air System respiratory protection rating (TH3/TM3).

Batteries	
Duraflow Standard Battery	Duraflow Extended Duration Battery

Belts	
Standard Belt	Comfort Belt

Spares & Accessories	
Decontamination plugs pack: 1 x breathing tube cap and 2 x filter caps	
Backpack	

Chargers	
Single Station Battery Charger Kit	

3M™ Modular Respirator Systems

3M™ Scott™ Proflow™ 160 Powered Air Turbo

Intelligent and easy to use, the 3M™ Scott™ Proflow™ 2 SC 160 features an ergonomic design incorporating a curved backplate, which can help user comfort. The onboard control system continually monitors the status of the power pack and adjusts the air flowrate.

Typical Applications

- Pharmaceutical manufacturing
- Food & beverage
- Woodworking
- Metal working
- Surface preparation
- Smelting

Features and Benefits:

Intelligent Protection

- Air flowrate is electronically controlled, maintaining a comfortable air flow. The turbo unit automatically compensates for a change in filter resistance
- Onboard data-logging records usage of the turbo unit to provide reliable and downloadable maintenance information.
- Approved Service Centres can provide diagnostic checks, servicing and repairs and provide full service history records

Compatibility

- Proflow 2 SC 160 is designed to be compatible with the 3M™ Scott™ range of headtops and helmets and the Pro2000 Series of filters.

Ease of use

- Proflow 2 SC 160 features a simple button operation for ease of use.
- The button is shielded to prevent accidental shut off.
- The integrated battery is safely enclosed within the Turbo Unit casing and is rechargeable in-situ.



Filter	Protection
PF10 P3 R	P S L
CF22 A2P3 R	A P S L
CF22 B2P3	B P S L
CF22 A2B2P3 R	A B P S L
CF22 A2B2E2 P3 R	A B E P S L
CF32 A2B2E2K2-P3 R	ABEK P S L
CF32 A2B2E2K2 Hg P3 R	ABEK Hg P S L

* Please Note that Hg filters are only approved with the highest Powered Air System respiratory protection rating (TH3/TM3).

Belts	
Standard Belt	Comfort Belt

Spares and accessories	
Backpack	Shower Plugs
Shower Cover	Disposable Cover
Peel-off visors	

Chargers	
Smart Charger	Vehicle Charging Socket

3M™ Proflow™ Powered Air Turbo Kits

3M™ Proflow™ Starter Kit

This Proflow Starter Kit includes the Proflow Turbo, comfort belt, and battery charger.

Also available:

3M™ Scott™ Proflow SC Asbestos - designed for workers in Asbestos environments



3M™ Modular Respirator Systems

3M™ Scott™ Tornado™ Powered Air Turbo

The 3M™ Scott™ Tornado™ is a compact particulate only powered air respirator which is comfortable and easy-to-use. The Tornado system features a low profile and single filter turbo unit.

Typical Applications

- Pharmaceutical manufacturing
- Food & beverage
- Woodworking
- Metal working
- Surface preparation
- Smelting

Features and Benefits:

Ease of use

- Tornado features a simple button operation for ease of use.
- Audible and visual alarms on the user interface indicate the need to recharge the unit or replace the particulate filter.
- Batteries are removable to allow users to charge and change without lengthy interruptions to work.
- A smart-charger indicates charging status and reverts to trickle charge allowing a fully charged battery to remain plugged-in on standby.

Turbo Unit performance

- At the heart of the Tornado Powered Air System is the T-Power. T-Power features an electronic air management system.
- The turbo unit monitors airflow rates and as filters are used and reduce in efficiency, the unit compensates airflow so that a minimum 140l/min for loose fitting headtops and 120l/min for tight fitting facepieces is maintained.



PF251 Particulate Filter



PF251 High Capacity Particulate Filter



Tornado Battery



Single station smart charger

Filter	Protection
PF251	P S L
PF251 High Capacity	A P S L

Batteries
Tornado NiMH Battery

Chargers	
Individual Smart Charger	10-station smart charger

Belts	
Standard Belt	Comfort Belt

Spares and accessories	
Backpack	Large system storage box

3M™ Modular Respirator Systems

3M™ Scott™ Breathing Tubes

A breathing tube connecting the air source with the headtop is required to ensure that clean air reaches the headtop reliably and with unrestricted airflow. The 3M™ Scott™ breathing tubes offered are compatible with 3M™ Scott™ Headtops and Air Delivery Units*.

Features and Benefits:

- Bayonet connection breathing tubes allow fast and easy connection to powered air respirators
- Specific breathing tubes available depending upon headtop selection; contact 3M™ Scott™ for further information



3M™ Scott™ Breathing Tube PU Stretch
Lightweight breathing tube that stretches and flexes with the wearers movements.



3M™ Scott™ Breathing Tube PU Fixed Length
Lightweight, fixed length breathing tube. Available in 2 lengths.



3M™ Scott™ Breathing Tube EPDM
Lightweight, EPDM Rubber breathing tube.

* 3M™ Scott™ breathing tubes are not compatible with Versalo™ systems.

3M™ Individual Respirator Systems

3M™ S-200+ Supplied Air System

The 3M™ Supplied Air Respirator System S-200+ is a comfortable and versatile supplied air respirator system for use with the 3M™ 6000 and 3M™ 7000 Series Half and Full Face Masks. The S-200+ System by 3M can be used as a standard airline respirator system or in dual-mode with filter back-up when air supply is disconnected.

Engineered to deliver additional comfort and security, the S-200+ features double-action safety couplings to help minimise the risk of accidental disconnection during use and an adjustable airflow feature so you can control the air across your face for maximum comfort.

Features and Benefits:

Cool and Comfortable

- Lightweight and balanced system with a constant flow of air across the face for a cooler and more comfortable wear

Adjustable Airflow

- Lockable airflow adjustment knob giving you full control of a range of input pressure

Double Action Couplings

- Help to minimise the risk of accidental disconnection during use giving you enhanced confidence in protection
- Stainless Steel CAST Connection, offering improved corrosion resistance in tough conditions

ATEX Tested

- Assessed in accordance with the requirements of the ATEX directive and in accordance with EN13463-1 for non-electrical equipment
- Suitable for use in IIB 2GD environments under certain conditions. Please see all relevant user information for further details

Top Performance

- Tested and approved to EN14594:2005
- Meets the highest level of protection, Class 4B for continuous flow supplied air respirators when fitted to a full face mask

Quick and Easy Maintenance

- Easy to maintain, spare parts are quick, easy and intuitive to replace

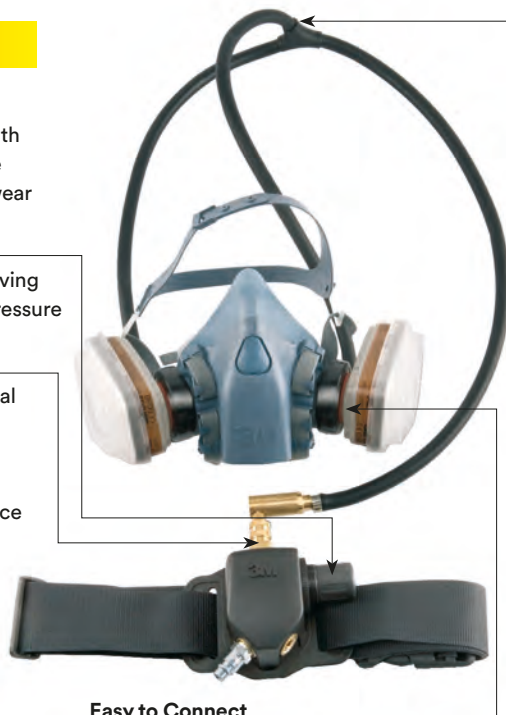

Easy to Connect

- Robust, proven bayonet connection to the facepiece and filter provides easy fitting with confidence of security

Easy Movement

- Low profile, narrow-bore breathing tube for ease of movement and helps to reduce interference with your work

Typical Applications

- Spray Painting
- Glass Fibre Fabrication
- Powder Coating
- Material Handling
- General Transport
- Boat building
- Metal Fabrication
- Pharmaceutical
- Oil and Gas
- Automotive & Aerospace

3M™ S-200+ Supplied Air System

Approvals: EN14594

NPF*: 3M Half Face Masks (Class 3A/B**) = 200
3M Full Face Masks (Class 4A/B**) = 2000

Pressure range: 3.0 – 7.0 Bar

Pressure range (with Auxiliary air tool connected): 4.5-7.0 Bar

Maximum Pressure: 10 Bar

Select Your Individual Respirator System:

1. Choose the S-200+ Air Delivery Unit
2. Choose your half face or full face mask
3. Choose your filters (for use in dual-mode)
4. Choose the appropriate air supply tube
5. Choose your accessories and air tools (optional)



Flow Check Bag FCB-01

The S-200+ includes a Flow Check Bag allowing you to conduct a simple pre-use check to ensure that the correct amount of air is being delivered - giving you peace of mind

* Nominal Protection Factor – a number derived from the maximum percentage of total inward leakage permitted in relevant European Standards for a given class of respiratory protective devices.

**When used with a 3M™ recommended Full Face mask the product meets the requirements for a class 4A/B device. When used with a 3M™ recommended Half Face mask the product meets the requirements for a class 3A/B device.

3M™ Individual Respirator Systems

3M™ Scott™ Phantom Vision™ Powered Air System for Asbestos Environments

The 3M™ Scott™ Phantom Vision™ has been designed specifically to meet the requirements of workers in the asbestos industry. Phantom Vision is a particulate only powered air system which combines a belt mounted battery pack and mask mounted motor, based on the Vision Full Face mask. The system provides protection against respiratory, face and eye hazards whilst working in environments containing asbestos.

Typical Applications

- Asbestos stripping
- Abatement
- Demolition
- Construction

Features and Benefits:

Visibility and comfort

- Large field of vision
- 5 strap-harness
- Visor material: Hard coat polycarbonate
- Mask and motor weight is approx. 680g
- Battery and belt weight is approx. 860g

Cleaning and decontamination

- Ingress Protection rating when showering: Motor/fan assembly is IP54 rated and switch at mask is IP67. Unit not to be submerged
- Exhale valve cover designed to avoid trapping fibres or particles, and to direct shower water away from the valve
- After use, Phantom Vision™ is quick and easy to disassemble for further cleaning

Air flow

- High performance brushless motor provides manufacturer's minimum design flow rate (MMDF) of 160l/min, reliable full-shift (8hr) operation and a long service life

Ease of Use

- Phantom Vision™ is available in three sizes to suit a wide range of users
- Phantom Vision™ may be serviced and all major parts are modular for rapid replacement
- The rotary connection to the mask allows the power cable to be freely directed to suit the wearer
- Phantom Vision™ is supplied in a sturdy carry case to keep it clean and safe during transit and storage







Hearing solutions

3M™ Hearing Protection Solutions

The Challenge of Hearing Protection

40 million workers are exposed to loud noise and 13 million suffer from hearing disorders despite industry regulations*.

You can advance your hearing conservation programme with a customised and comprehensive approach to the hearing protection challenge. Implementing a solution that really makes a difference begins with understanding the hazards, the regulation and the factors that impact protection.

* Source: European Agency for Safety and Health at Work

The Facts

The #1 Reported Occupational Health Issue: data from the European Agency for Safety and Health at Work shows that noise induced hearing loss is the most commonly reported occupational medical condition in the EU.

One third of European employees potentially at risk: according to the EU OSHA one third of workers in Europe are exposed to potentially dangerous levels of noise.

The Regulations

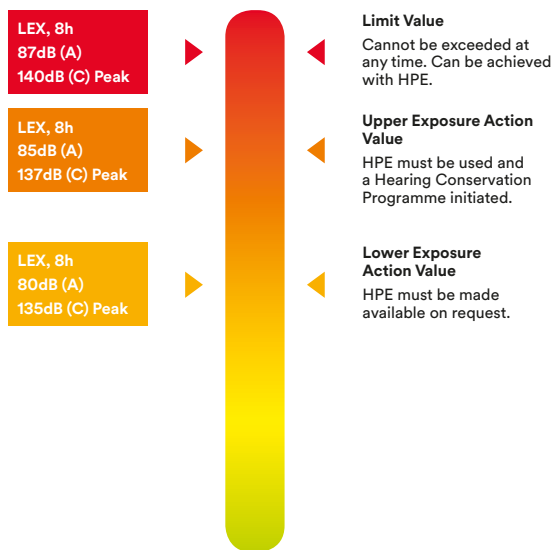

At the Lower Exposure Action Value, suitable hearing protectors must be made available on request. At the Upper Exposure Action Value, hearing protectors must be worn and information provided to workers on risks, control measures, hearing protectors and safe working practices. An effective hearing conservation programme should also be instigated.

The Limit Value is an absolute value which must not be exceeded under any circumstances and can be achieved by using hearing protectors.

The Hazards

At home and work, it's important to understand which sounds may cause hearing loss and require hearing protection.

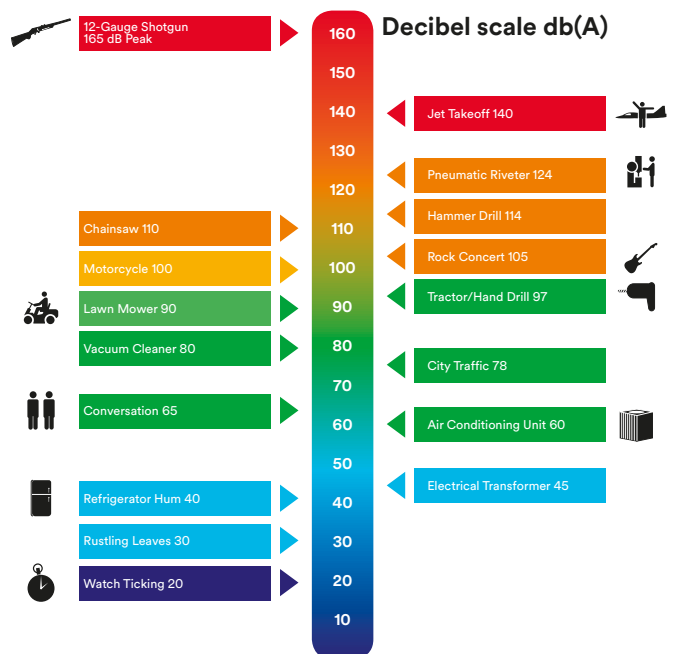

The Real World Hearing Concerns of Hearing Protection
Variable Noise Levels: Every environment is different and workers can face a wide range of sound levels throughout the day and in different areas at the same facility.

The Human Factor: Each person has a different shape, size and anatomy of the ear canal, so there is no one-size fits all hearing protection solution. The key to achieving optimal protection is having the best fit possible.

Employee Communication: Where there is an essential need for workers to communicate or hear warning sounds it is vital that their hearing is protected from hazardous noise levels.

3M™ Hearing Protection Solutions

The Solution, Protection and Validation

As a global leader in hearing protection and fit test validation, 3M delivers easy and comprehensive solutions to complex hearing protection challenges.

Accurate Noise Detection. The first step in solving the challenge is to measure the noise levels facing your workers. Detection is a key part of the hearing conservation process. See the 3M 7 step guide to hearing conservation.

Adaptable Hearing Protection. 3M delivers a wide range of innovative hearing protectors, making it easy to select the right solution for the job. A variety of types and sizes of earplugs and earmuffs are available helping your team determine the right fit for each person and the right protection for the application. Our innovative products are designed for comfortable, extended wear, and they can help your team comply with your safety program.

Fit Test Validation. Integrating hearing protector fit testing into your hearing conservation program benefits everyone from new hires to high-risk workers. The 3M™ E-A-Rfit™ Dual-Ear Validation System makes it easier to fit, train and motivate workers and to assess and manage the long-term performance of your hearing conservation program.

3M's broad range of hearing protection devices in a variety of types and styles helps you solve many of the challenges facing workers in various environments.

*E·A·R*fit™







Hearing Protection

Hearing protection must be right for you and your situation. For safety, productivity and comfort, it must reduce noise by the right amount, not too little and not too much. 3M can provide solutions for different individuals and applications with a wide range of earmuffs and earplugs. Hearings move to Category 3 is a key legislation change which should be used to highlight the importance of using certified accredited HPE.

3M™ Hearing Protection

3M™ Optime™ Alert System by Product

Our system uses a simple, logically coloured classification to make the selection process easy. Firstly find out what your noise level is, then look at the icons below and establish which noise band (RNR) your noise level falls into. Take note of the icon and choose from the wide range of products featuring the correct icon (see summary table on next page). The 3M Optime™ Alert system has been incorporated into the 3M SD-200 sound detector that highlights the appropriate 3M hearing protection required.

*RNR = Recommended Noise Rating



GREEN OPTIME™ ALERT SYSTEM RNR* < 85dB(A)

Hearing protection is not compulsory but is made available to workers for their comfort and protection.

3M™ E-A-R™ UltraFit™ 14 Earplugs - SNR: 14dB



YELLOW OPTIME™ ALERT SYSTEM 83dB(A) - 93dB(A)

You must assume you are above the permitted exposure level, hearing protection is compulsory.

3M™ E-A-Rsoft™ 21 Earplugs - SNR: 21dB
 3M™ E-A-R™ UltraFit™ 20 Earplugs - SNR: 20dB
 3M™ E-A-R™ ClearE-A-R™ 20 Earplugs - SNR: 20dB
 3M™ E-A-R™ Tracers™ 20 Earplugs - SNR: 20dB
 3M™ E-A-R™ UltraTech Earplugs - SNR: 21dB
 3M™ E-A-R™ EARband Earplugs - SNR: 21dB
 3M™ E-A-R™ Caboflex™ - SNR: 21dB



RED 1 OPTIME™ ALERT SYSTEM 87dB(A) - 98dB(A)

You are above the permitted exposure level, hearing protection is compulsory. Ideal for high frequency noise.

3M™ E-A-R™ Classic™ Earplugs - SNR: 28dB
 3M™ E-A-R™ Express™ Earplugs - SNR: 28dB
 3M™ Earplugs 1261/ 1271 - SNR: 25dB
 3M™ E-A-Rcaps™ - SNR: 23dB
 3M™ E-A-R™ Flexicap - SNR: 23dB
 3M™ E-A-R™ 1310 - SNR: 26dB
 3M™ E-A-R™ Reflex™ - SNR: 26dB
 3M™ PELTOR™ Optime™ I Earmuffs - SNR: 26/27/28dB (depending on the version)
 3M™ Bull's Eye™ I Earmuff - SNR: 27dB
 3M™ PELTOR™ H31 Earmuffs - SNR: 27/28dB (depending on the version)
 3M™ Peltor™ Earmuff X1 - SNR: 27 dB



RED 2 OPTIME™ ALERT SYSTEM 94dB(A) - 105dB(A)

You are above the permitted exposure level hearing protection is compulsory. Ideal for high and medium frequency noise.

3M™ E-A-R™ Classic™ Earplugs - SNR: 29dB
 3M™ Torque™ Earplugs - SNR: 32dB
 3M™ Tri-Flange™ Earplugs - SNR: 29dB
 3M™ E-A-R™ Tracers™ Earplugs - SNR: 32dB
 3M™ E-A-R™ UltraFit™ Earplugs - SNR: 32dB
 3M™ PELTOR™ Optime™ II Earmuffs - SNR: 30/31dB (depending on the version)
 3M™ Bull's Eye™ II Earmuff - SNR: 31dB
 3M™ Peltor™ Earmuff X2 - SNR: 31dB



RED 3 OPTIME™ ALERT SYSTEM 95dB(A) - 110dB(A)

You are above the permitted exposure level, hearing protection is compulsory. Ideal for all frequencies.

3M™ E-A-R™ Classic™ Soft Earplugs - SNR: 36dB
 3M™ E-A-R™ Classic™ SuperFit™ 33 Earplugs - SNR: 33dB
 3M™ 1120/1130 Earplugs - SNR: 34dB
 3M™ E-A-Rsoft™ Yellow Neons™ Earplugs - SNR: 36dB
 3M™ E-A-Rsoft™ Metal Detectable Earplugs - SNR: 36dB
 3M™ Solar™ Earplugs - SNR: 36dB
 3M™ 1100/1110 Earplugs - SNR: 37dB
 3M™ E-A-Rsoft™ FX™ Earplugs - SNR: 39dB
 3M™ No-Touch™ Foam Earplugs - SNR: 35dB
 3M™ E-A-R™ Push-Ins Earplugs - SNR: 38dB
 3M™ E-A-R™ UltraFit™ X Earplugs - SNR: 35dB
 3M™ PELTOR™ Optime™ III Earmuffs - SNR: 34/35dB (depending on the version)
 3M™ Bull's Eye™ III Earmuff - SNR: 35dB
 3M™ Peltor™ Earmuff X3 - SNR: 33 dB
 3M™ Peltor™ Earmuff X4 - SNR: 33
 3M™ Peltor™ Earmuff X5 - SNR: 37 dB



PLEASE NOTE:

At levels above 95dB(A) you will need an accurate noise assessment to correctly select the product. Green and Yellow marked products are not suitable for use in low frequency noise.

3M™ Hearing Protection

3M™ Disposable Earplugs

Our 3M™ Disposable Earplugs are made from expandable Polyurethane (PU) foam, which provides great comfort and good protection. The one size fits most ear canals. Once inserted in the ear, the foam plugs expand to provide a snug and secure custom fit. 3M provides a wide range of disposable roll down PU foam earplugs to choose from and to find the best solution for your individual needs.



Features and Benefits:

Comfortable

- Soft hypoallergenic foam material for lower pressure inside the ear
- Smooth, dirt resistant surface for better hygiene, durability and comfort

Convenient

- Tapered design fits most ear canals making the plugs easier to use
- One size only
- Dispenser available (1100)
- Polyester cord (1110) helps prevent loss of earplugs

Effective

- High SNR of 37dB

Compatible with

- Designed to be compatible with other PPE

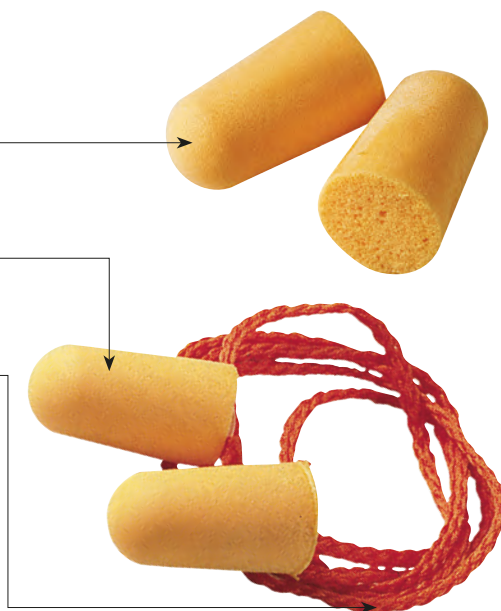

Attenuation*

3M™ Earplugs 1100/1110

Frequency (Hz)	63	125	250	500	1000	2000	4000	8000
Mean Attenuation (dB)	30.0	33.1	36.3	38.4	38.7	39.7	48.3	44.4
Standard Deviation (dB)	3.9	5.0	7.4	6.2	5.6	4.3	4.5	4.4
Assumed Protection (dB)	26.1	28.1	28.9	32.2	33.1	35.4	43.8	40.0

SNR=37dB H=37dB. M=34dB. L=31dB

3M™ Disposable Earplugs 1100/1110

Available corded, uncorded and with dispenser SNR: 37dB

Other 3M™ Disposable Earplugs



3M™ Earplugs 1120/1130

Especially designed for smaller ear canals
Available corded, uncorded and with dispenser
SNR: 34dB



3M™ Solar™ Earplugs

Colourful Earplugs
Available corded, uncorded and with dispenser
SNR: 36dB



3M™ E-A-R™ EARsoft™ Yellow Neons™

The E-A-R™ standard PU earplugs. Available corded (Yellow Neons), uncorded and with dispenser
Compatible with E-A-Rfit™ validation system
SNR: 36dB



3M™ E-A-R™ EARsoft™ 21 Earplugs

The low attenuation disposable earplugs
Only available uncorded
SNR: 21dB



3M™ E-A-R™ EARsoft™ FX Earplugs

The highest attenuation. Available uncorded
SNR: 39dB



3M™ E-A-R™ EARsoft™ Metal Detectable Earplugs

The traceable disposable earplugs with cord. Compatible with E-A-Rfit™ validation system
SNR: 36dB

3M™ Dispenser 1100B and 1120B

Now 3M One-Touch dispenser also available to dispense 3M™ Earplugs 1100 and 1120



3M™ E-A-R™ One-Touch™ Dispenser



* For further attenuation information please visit www.3M.eu/PPESafety

3M™ Hearing Protection

3M™ E-A-R™ Classic™ Earplugs

40 years ago this simple hearing protector, the world's first foam earplug, revolutionised hearing protection in the workplace and has remained to this day one of the most widely used earplugs in the world. Since its introduction to the market no other earplug has been studied and assessed in the field more comprehensively than the E-A-R Classic. Discover for yourself what makes the E-A-R Classic earplug so different and why it remains one of the most popular choices of earplug in the world today for attenuation, comfort and ease-of-fit.



Features and Benefits:

Attenuation

- Features a proprietary slow recovery vinyl foam, engineered to protect against noise and vibration
- Expands to the shape of the wearer's ear canal, thereby providing an effective acoustic seal
- Fully tested and CE approved against EN352-2:1993
- The unique 3M™ E-A-Rfit™ Validation System allows users to obtain their own personal attenuation rating to help ensure best fit and protection

Comfort

- Cylindrical shape: Flat and cylindrical to provide an effective seal even with jaw movement
- Sweat and humidity resistant, enables easier fitting and helps prevent moisture build up in the ear canal
- Textured surface, provides greater friction to prevent slippage and maintain an effective seal over a prolonged wear time
- Soft energy absorbing foam offers a low equilibrium pressure

Ease-of-Fit

- Firm foam properties prevent the earplug from folding or collapsing when inserted into the ear canal
- Quick and easy to roll down with slow recovery foam for a good custom fit

Attenuation*

3M™ E-A-R™ Classic™ Earplugs (Uncorded version)

Frequency (Hz)	63	125	250	500	1000	2000	4000	8000
Mean Attenuation (dB)	22.3	23.3	24.6	26.9	27.4	34.1	41.6	40.4
Standard Deviation (dB)	5.4	5.3	3.6	5.4	4.8	3.1	3.5	6.4
Assumed Protection (dB)	16.9	18.1	20.9	21.5	22.6	30.9	38.1	34.0

SNR=28dB H=30dB. M=24dB. L=22dB

* For further attenuation information please visit www.3M.eu/PPEsafety

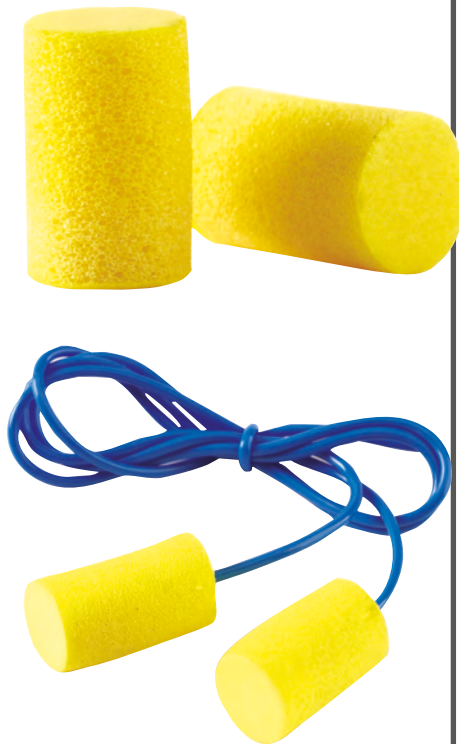

3M™ E-A-R™ Classic™ Earplugs

Available corded, uncorded and with dispenser
SNR: 28dB

Other 3M™ Disposable Earplugs



3M™ E-A-R™ Classic™ Soft Earplugs

Softer Classic earplugs for increased comfort
Available corded, uncorded and with dispenser
SNR: 36dB



3M™ E-A-R™ Classic™ Small Earplugs

Reduced diameter for smaller ear canals
Only available uncorded
SNR: 28dB



3M™ E-A-R™ Superfit™ 33 Earplugs

With exclusive fitting ring
Available uncorded and with dispenser
SNR: 33dB



3M™ E-A-R™ Superfit™ 36 Earplugs

With exclusive fitting ring
Available uncorded in Pillowpack
SNR: 36dB



3M™ E-A-R™ One-Touch™ Dispenser

3M™ Hearing Protection

3M™ Push-to-Fit

3M™ Push-to-Fit earplugs are very easy to insert since there is no roll down needed: just use the soft flexible grip to push the earplug into position and achieve excellent protection. Because you do not have to touch the foam during fitting it is one of the most hygienic types of earplug available.



Features and Benefits:

Comfortable

- Unique pod design allowing the foam to compress easily
- The plug slides gently into the ear and expands slowly
- Patented E-A-Rform foam tip shaped and sized to mold comfortably fitting virtually every size ear canal

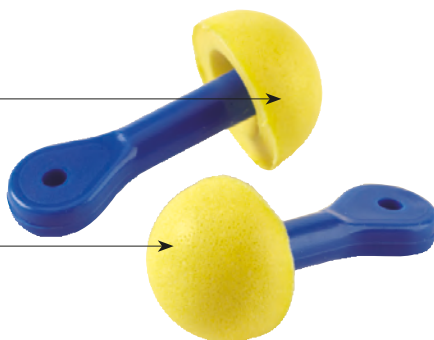

Convenient

- Available corded or uncorded
- No roll down required
- Washable and reusable
- The insertion stem eliminates the need to touch the tip: no need to clean your hands



Compatible with

- Designed to be compatible with other PPE

Attenuation*

3M™ E-A-R™ Express Earplugs

Frequency (Hz)	63	125	250	500	1000	2000	4000	8000
Mean Attenuation (dB)	27.8	26.0	24.9	25.2	29.4	34.9	37.0	35.9
Standard Deviation (dB)	5.4	4.5	3.3	5.0	4.2	4.1	5.2	3.7
Assumed Protection (dB)	22.4	21.5	21.5	20.2	25.2	30.8	31.8	32.2

SNR=28dB H=30dB, M=24dB, L=22dB

* For further attenuation information please visit www.3M.eu/PPESafety

3M™ E-A-R™ Express™ Earplugs

Available corded, uncorded
SNR 28dB

Other Pod Earplugs



3M™ Torque™ Earplugs
The tough pod plugs
Available corded
SNR: 32dB



3M™ No-Touch™ Earplugs
The colourful pod earplugs
Available corded
SNR: 35dB



3M™ E-A-R™ Push-Ins™ Earplugs
The disposable pod earplugs with high attenuation
Available corded and uncorded
Compatible with E-A-Rfit™ validation system
SNR: 38dB

3M™ Hearing Protection

3M™ Reusable Earplugs

3M™ Reusable Earplugs are made from flexible materials that are preformed to fit the ear. They are generally available with a joining cord to prevent loss. These reusable earplugs are comfortable, hygienic and economical. No sizing is required for these patented, pre-moulded, triple flanged earplugs. Available in a variety of styles and protection levels.



Features and Benefits:

Comfortable

- Unique and patented tri-flange design for a perfect fit and comfort
- Easy to fit in the ear for a continuous and comfortable protection

Effective

- High attenuation (SNR: 32dB)

Convenient

- Available with a cord to prevent loss
- Washable and reusable
- Compatible with E-A-Rfit™ validation system to check Personal Attenuation Ratings

Versatile

- Different versions to various use: traceable, high and low attenuation versions

Compatible with

- Designed to be compatible with all types of PPE

Attenuation*

3M™ E-A-R™ Ultrafit™ Earplugs

Frequency (Hz)	63	125	250	500	1000	2000	4000	8000
Mean Attenuation (dB)	29.2	29.4	29.4	32.2	32.3	36.1	44.3	44.8
Standard Deviation (dB)	6.0	7.4	6.6	5.3	5.0	3.2	6.0	6.4
Assumed Protection (dB)	23.2	22.0	22.7	26.9	27.3	32.8	38.3	38.4

SNR=32dB H=33dB. M=28dB. L=25dB APVf = Mf - sf

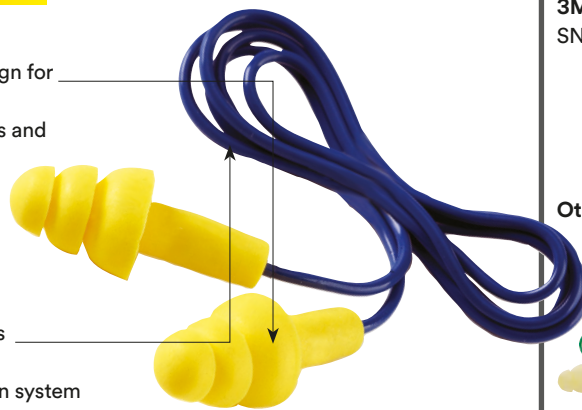

3M™ E-A-R™ Ultrafit™ Earplugs
SNR: 32dB

Other pre-moulded earplugs

3M™ E-A-R™ Ultrafit™ 14 and Ultrafit™ 20 Earplugs

The low attenuation E-A-R™ Ultrafit™ versions
SNR: 14dB
SNR: 20dB

3M™ E-A-R™ ClearEAR™ Earplugs
SNR: 22dB

3M™ E-A-R™ Switch Protection Earplugs
Special acoustic filter that lets lower level of sound through with little noise reduction for greater situational awareness
SNR: 16 dB (open mode)
SNR: 28 dB (closed mode)

3M™ Earplugs 1261/1271
The pre-moulded earplug with convenient storage case
Available corded and uncorded
SNR: 25dB

3M™ E-A-R™ Tracers™ and Tracers™ 20 Earplugs
Metal detectable version
SNR: 32dB
SNR: 20dB



3M™ Tri-Flange™ Earplugs
Comfort and design
Available with vinyl or cotton cord
SNR: 29dB



3M™ E-A-R™ Ultrafit™ X Earplugs
The high attenuation pre-moulded earplugs
Available corded
SNR: 35dB

* For further attenuation information please visit www.3M.eu/PPEsafety

3M™ Hearing Protection

3M™ Banded Earplugs

3M™ Banded Earplugs are easy to use, convenient and extremely comfortable. They are quick to insert and remove and can be stored around the neck when not required, making them ideal for intermittent use. Banded hearing protectors offer simplicity to help improve the choice of hearing protection products that best suits the work place environment. Most models are available with replacement pods making them a more cost-effective option.



3M™ Banded Earplugs can be worn in a variety of modes:
 Behind-the-Head (B-T-H)
 Under-the-Chin (U-T-C)
 and/or Over-the-Head (O-T-H)

Features and Benefits:

Comfortable

- Extremely light
- Very low pressure into the ear
- Pod plugs seal the entrance part of the ear canal with no deep insertion

Convenient

- Wear in Under-the-Chin (U-T-C) mode
- Easy to use
- Ideal for people moving in and out
- Replacement pods available

Compatible with

- Designed to be compatible with other PPE

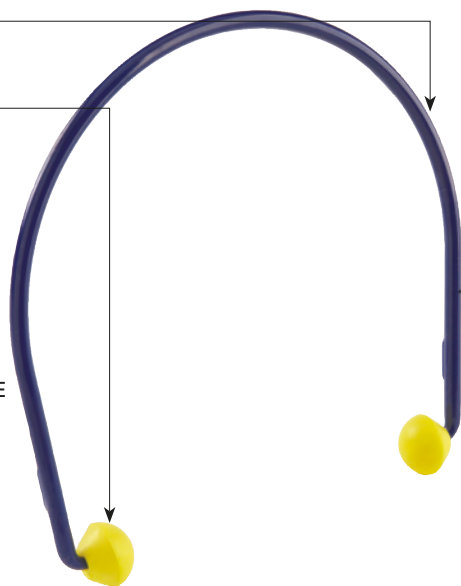

Attenuation*

3M™ E-A-R™ EARcaps™ Earplugs (In U-T-C mode)

Frequency (Hz)	63	125	250	500	1000	2000	4000	8000
Mean Attenuation (dB)	21.0	20.2	19.8	19.1	23.2	33.4	41.0	40.7
Standard Deviation (dB)	4.1	4.4	4.2	4.3	3.7	4.5	2.9	5.4
Assumed Protection (dB)	16.9	15.8	15.5	14.8	19.5	29.0	38.1	35.2

SNR=23dB H=27dB. M=19dB. L=17dB

3M™ E-A-R™ EARcaps™ Earplugs

Replacement pods available
 SNR: 23dB (U-T-C)

Other banded earplugs



3M™ E-A-R™ EARband Earplugs

The ergonomic banded earplugs Replacement pods available. Wear Behind-the-Head
 SNR: 21db (B-T-H)



3M™ E-A-R™ Caboflex™ Earplugs

The banded earplugs with durable conical shaped insert Replacement pods available. Wear Behind-the-Head or Under-the-Chin
 SNR: 21dB (U-T-C)



3M™ E-A-R™ Flexicap Earplugs

The multi-position banded earplugs Replacement pods available. Wear Behind-the-Head, Under-the-Chin or Over-the-Head
 SNR: 23dB (U-T-C)



3M™ Earplugs 1310
 The high flexibility band Replacement pods available. Wear Behind-the-Head or Under-the-Chin
 SNR: 26dB (U-T-C)



3M™ E-A-R™ Reflex Earplugs
 The multi-position banded earplugs with conical tips Replacement pods available. Wear Behind-the-Head, Under-the-Chin or Over-the-Head
 SNR: 26dB (U-T-C)

* For further attenuation information please visit www.3M.eu/PPESafety

3M™ Hearing Protection

3M™ PELTOR™ Optime™ Earmuffs

The 3M™ PELTOR™ Optime™ Earmuffs have been developed for demanding noisy environments and are effective in reducing even extremely low frequency sound. The sealing rings are filled with a unique combination of liquid and foam. The result is an optimum seal with low contact pressure, which provides agreeable comfort even during long periods of use. The sealing rings have ventilation channels and are covered with soft, patterned, hygienic foil. The product is also available in an electrically insulated (dielectric) version without visible metal parts



Features and Benefits:

Comfortable

- Generous space inside the cup to help the ears breathe thus improving comfort
- Soft and wide sealing rings filled with a unique combination of foam and liquid to offer optimum sealing and low pressure
- Sealing rings with ventilation channels and covered with soft, patterned hygienic foil

Effective

- High attenuation despite lightness and low profile design: 31dB SNR
- Unique band design, stainless steel wire for constant pressure over long periods of use

Versatile

- Available in several versions including: Headband, foldable, neckband and helmet mounted versions. All versions are available in high visibility colours



3M™ PELTOR™ Optime™ II Earmuffs Headband
SNR: 31dB

Accessories

Hygiene kits are available for each earmuff version

Other PELTOR™ Optime™ Earmuff options:



3M™ PELTOR™ Optime™ Neckband
Offers excellent compatibility with other PPE
Optime™ I SNR: 28dB
Optime™ II SNR: 31dB
Optime™ III SNR: 35dB



3M™ PELTOR™ Optime™ Foldable Headband
Easy-to-store solution
Optime™ I SNR: 28dB
Optime™ II SNR: 31dB



3M™ PELTOR™ Optime™ Helmet attachment
Can be worn with a wide range of safety helmets
Optime™ I SNR: 26dB
Optime™ II SNR: 30dB
Optime™ III SNR: 34dB



3M™ PELTOR™ Optime™ Hi-Viz Headband
For workers in need of extra visibility
Optime™ I SNR: 28dB
Optime™ II SNR: 31dB
Optime™ III SNR: 35dB



3M™ PELTOR™ Welding Earmuff
Designed for welders
Fits into welding helmets
Optime™ I SNR : 24dB



3M™ PELTOR™ Optime™ I Earmuffs Headband

Features:
Low profile, light-weight design (180g) helps improve compatibility with other safety equipment
Moderate attenuation:
SNR: 27dB



3M™ PELTOR™ Optime™ III Earmuffs Headband

Features:
Broad sealing rings
Very high attenuation:
SNR: 35dB
Twin cup design minimises resonance for excellent high-frequency attenuation



3M™ PELTOR™ Optime™ Push To Listen (PTL)
Optime™ Earmuff with a listening function Optime™ II
SNR: 31dB
Also available in Hi-Viz and Helmet mounted version
Optime™ II SNR: 29dB

* For further attenuation information please visit www.3M.eu/PPEsafety

3M™ Hearing Protection

3M™ PELTOR™ Earmuffs X Series

The 3M™ PELTOR™ Earmuffs X Series have been developed on the basis of design, comfort and attenuation techniques. This new range sets a new standard for over-the-ear protection. The 3M™ PELTOR™ X3 earmuffs are the first of our new range of products to utilise a newly designed spacer to help improve attenuation without the need for double cup design, thus increasing the space inside the cup for greater comfort and wearability.



Features and Benefits:

Comfort

- Easy to adjust headband
- Electrically insulated (dielectric) wire headband with constant pressure over long wearing periods
- Twin headband design helps reduce heat build-up and provides a good fit and balance
- Earcups tilt for optimum comfort and efficiency

Protection

- New ear cushion foam technology for an effective acoustic seal and reliable protection
- New smart sealing ring
- Streamlined cups without compromising attenuation
- Compatible with a range of 3M eyewear and respirators (validated by internal testing)
- Also available as a helmet mounted version

Design

- Lightweight dual mould cups with maximum space inside to help minimise heat and moisture build up
- Integrated design for more robustness
- Colour-coded for ease of selection
- Easy to clean



3M™ PELTOR™ X1, X2 and X3 Earmuffs



3M™ PELTOR™ X1 Earmuffs
SNR: 27dB
Available as headband or helmet mounted version. Colour coded green, indicating first level of attenuation within this range

Engineered around protection, comfort and design, making it highly versatile



3M™ PELTOR™ X2 Earmuffs
SNR: 31dB
Available as headband or helmet mounted version. Colour coded yellow, for moderately-high noise exposures

Based on the X1 design, but offering higher attenuation



3M™ PELTOR™ X3 Earmuffs
SNR: 33dB
Available as headband or helmet mounted version. Colour coded red for high noise exposure applications

Accessories



3M™ PELTOR™ Wireless Communication Accessory
SNR: from 27dB to 36dB

MT6705WS6-EU

When fitted to the 3M™ Peltor™ X Series Earmuffs, the Bluetooth accessory converts the passive hearing protector into a wireless communication device. The Bluetooth accessory is automatically paired with your mobile devices thus enabling hands-free communication in noisy environments, without compromising protection.

The accessory is designed for use with the following 3M™ Peltor™ X Series Earmuffs:

Headband: X1A, X2A, X3A, X4A, X4A-OR and X5A
Helmet mounted: X1P5, X1P5-OR, X2P5, X3P5, X4P5, X4P5-OR and X5P5

* For further attenuation information please visit www.3M.eu/PPESafety

3M™ Hearing Protection

3M™ PELTOR™ Earmuffs X Series

Historically higher attenuating earmuffs meant larger and bulky cups, but no longer. The 3M™ PELTOR™ Earmuffs X4 can attenuate by as much as 33dB whilst maintaining a sleek, low profile aesthetically pleasing design. Using the same innovative technology the 3M™ PELTOR™ X5 remains relatively lightweight with excellent balance and wearer comfort despite the larger cups, providing a SNR of 37dB.



Features and Benefits:

Comfort

- Easy to adjust headband
- Electrically insulated (dielectric) wire headband with constant pressure over long wearing periods
- Twin headband design helps reduce heat build-up and provides a good fit and balance
- Earcups tilt for optimum comfort and efficiency

Protection

- Unique attenuation as a result of optimum combination of specially-formulated foam featured in the earcups, cushions and the innovative spacer and cup design
- Newly designed spacer improves attenuation without excess bulk or weight
- Also available as a helmet mounted version

Design

- Extremely lightweight (234g)
- Integrated design for more robustness
- Colour-coded for ease of selection
- Easy to clean
- Extremely slim design providing excellent compatibility with other 3M personal protection products



3M™ PELTOR™ X4 and X5 Earmuffs



3M™ PELTOR™ X4 Earmuffs
SNR: 33dB
Available as headband or helmet mounted version
Colour coded Fluorescent yellow-green, for high noise exposure applications and to ensure good visibility when working outdoors

Features extremely slim and lightweight earcups which provide excellent compatibility when used with other 3M personal protection products.



3M™ PELTOR™ X5 Earmuffs
SNR: 37dB
Available as headband or helmet mounted version
Colour coded black for use in extremely high noise environments

Accessories



3M™ PELTOR™ Wireless Communication Accessory
SNR: from 27dB to 36dB

MT6705WS6-EU

When fitted to the 3M™ Peltor™ X Series Earmuffs, the Bluetooth accessory converts the passive hearing protector into a wireless communication device. The Bluetooth accessory is automatically paired with your mobile devices thus enabling hands-free communication in noisy environments, without compromising protection.

The accessory is designed for use with the following 3M™ Peltor™ X Series Earmuffs:

Headband: X1A, X2A, X3A, X4A, X4A-OR and X5A
Helmet mounted: X1P5, X1P5-OR, X2P5, X3P5, X4P5, X4P5-OR and X5P5

* For further attenuation information please visit www.3M.eu/PPEsafety



Communications Solutions

Close up or far away the 3M™ PELTOR™ Communication Solutions for noisy environments make it possible for users of hearing protectors to communicate very effectively – with their immediate environment and with people further away. The section focuses on the industrial solutions available. 3M™ PELTOR™ Communication Solutions also include more complex products for industry, military and hunting and shooting environments.

3M™ PELTOR™ Communication Solutions

The Sound Solution

First-class communication and hearing protection! There was a time when wearing hearing protectors meant being isolated and out of contact. Those days are over. Today, 3M™ PELTOR™ offers first-class communication solutions that not only make your working day safer and more efficient, but also much nicer!

3M™ PELTOR™ products are developed for all environments where high safety must be combined with communication. Industrial environments, construction sites, agriculture and forestry are a few examples.

We have developed several models to ensure there's a PELTOR Headset for every situation. Headband models for all-round use, and models with helmet attachments for people who wear safety helmets at work.

To ensure easy use of our products and good functions for all environments we use advance technology such as Level Dependent technology **Bluetooth®**.



Oil & Gas



Mining



Hunting & Sport shooting



Airport Ground handling



Military & Law enforcement



Energy & Utilities



Transportation



Industry

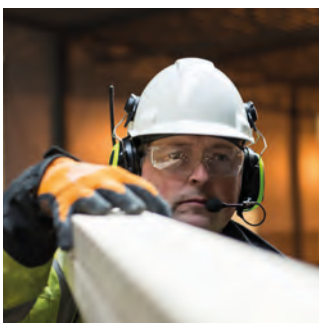

Construction

3M™ PELTOR™ Communication Solutions

The importance of wearing hearing protection 100% of time exposed



100% usage
Gives the expected protection.



99% usage
Just five minutes of carelessness per day significantly reduces the effect of the hearing protector.









90% usage
Virtually no protection.

Safety

To be effective, a hearing protector should be used 100% of the time in noisy environments. Even taking it off for a short time dramatically reduces its effectiveness and greatly increases the risk of hearing damage. The 3M™ PELTOR™ Communication Solutions encourage longer use because the wearer feels less isolated and can communicate with others more easily.

Function symbols

To help you to understand the functionality of the products you will find below symbols on each product page.

					
Hearing protection with level-dependent function for ambient listening	Hearing protection that features Bluetooth® technology, for wireless connection to mobile phone, or communication radio	Hearing protection with built in two-way radio	Hearing protection with built-in FM radio receiver	Hearing protection with external audio input	Hearing protection for communication with external two-way radio

Key Function

							
EEP-100 EU	Pro-Tac III	WorkTunes™ Pro	WS™ Pro-Tac XPI	WS™ Alert™ XP & XPI	LiteCom	LiteCom Plus	WS™ LiteCom
							
							
							
							
							

3M™ PELTOR™ Communication Solutions

3M™ Versaflo™ Helmets M-300 Series with 3M™ PELTOR™ LiteCom solutions

M-300 Series Helmets meet the highest powered respirator performance requirements (TH3) for this type of product when used with specific 3M™ Air Delivery Units. Now approved to be used with 3M™ PELTOR™ LiteCom headsets, M-300 Helmets offer you the possibility to communicate effectively whilst protecting your hearing in noisy environments.

Features and Benefits:

Highly versatile rigid headtops

- Head protection approved according to EN397
- Integrated protection from multiple hazards (e.g. respiratory, impact, splash hazards)

Modern, well balanced design

- Lightweight with excellent balance
- Fully-adjustable head suspension
- A deflector allows users to direct the airflow inside the headtop for increased control and comfort

Visor design

- Visor design combines excellent peripheral and downward vision with good optical clarity
- Lenses provide chemical and scratch resistance

Typical applications:

- Smelting & foundry applications
- Grinding
- Chemical processing & plant maintenance
- Agricultural applications
- Construction & renovation
- Demolition



Note: 3M does not accept responsibility or liability, direct or consequential, arising from reliance upon any information provided and the user should determine the suitability of the products for their intended use. Nothing in this statement will be deemed to exclude or restrict 3M's liability for death or personal injury arising from its negligence or fraudulent misrepresentation.



3M™ PELTOR™
MT53V/1



3M™ PELTOR™
MT7V/1
2 options of built-in
microphones:

- Dynamic
- Electret



Electronic Protectors

Size Ranges: S = Small, M = Medium, L = Large

Helmet model	Wedge	Product number	Description	Size
Versaflo™ M-306 or M-307 Helmet	Z3AF	MT**H79P3*	3M™ PELTOR™ Helmet Att. Headsets, Product numbers beginning with MT7H or MT53H except model number ending in -77	M/L
		MT7H540P3*	3M™ PELTOR™ Twin Cup Headsets, Helmet attached, except model number ending in -77	M/L
		MT*H7P3*	Helmet attached WS™ ProTac XP, WS™ Headset XP, Tactical XP, LiteCom, WS™ LiteCom, LiteCom PRO II, LiteCom Plus product numbers beginning with MT7H or MT53H	M/L



reddot design award
honourable mention 2011



3M™ PELTOR™ Communication Solutions

3M™ PELTOR™ Electronic Ear Plug EEP-100 EU

3M™ PELTOR™ Electronic Earplug helps protect against harmful noise, whilst allowing ambient sounds to be heard at a level below 82dB. It increases your ability to communicate with nearby colleagues, as well as hearing warning signals, approaching vehicles, or sounds in machines and processes.



Features and Benefits:



Ultrafit^{G1}

Frequency (Hz) ^{G2}	125	250	500	1000	2000	4000	8000
Mean Attenuation (dB) ^{G3}	34.5	31.5	36.2	33.4	34.8	34.9	38.8
Standard Deviation (dB) ^{G4}	6.0	5.4	5.6	4.3	3.8	5.0	4.0
Assumed Protection (dB) ^{G5}	28.5	26.1	30.6	29.1	31.0	29.9	34.8

^{G6} 9g SNR=32dB H=31dB. M=30dB. L=29dB

Torque^{G1}

Frequency (Hz) ^{G2}	125	250	500	1000	2000	4000	8000
Mean Attenuation (dB) ^{G3}	37.8	36.0	40.5	41.2	41.3	39.6	46.1
Standard Deviation (dB) ^{G4}	4.3	5.5	4.2	4.7	3.2	4.3	3.6
Assumed Protection (dB) ^{G5}	33.5	30.5	36.3	36.5	38.0	35.3	42.5

^{G6} 9g SNR=38dB H=37dB. M=36dB. L=34dB

Earpiece Power

Battery Type: Lithium Ion
Battery Life: Up to 16 Hours
Battery Charge Time: Approximately 180 Minutes
Volume Steps: Low, Normal, High
Case USB Type: Micro B

Standards

Waterproof Rating: Complies with IP54 with cover and USB port closed.
SNR: PPE directive 89/686/EEC

Physical Characteristics

Weight: Box containing charger, 2 earpieces, 4 pair communications eartips, USB cable - 240g
Weight: Charger - 57.1g
Weight: 1 earpiece - 4g

3M Peltor Accessories

TEP-CORD	3M™ PELTOR™ Tactical Earplug Replacement Cord
370-TEPL-25	3M™ UltraFit™ Communication Tips Replacement, Large, 25 pairs
370-TEPM-25	3M™ UltraFit™ Communication Tips Replacement, Medium, 25 pairs
370-TEPS-25	3M™ UltraFit™ Communication Tips Replacement, Small, 25 pairs
PELTIP5-01	3M™ Torque™ Eartips, 50 pairs
CCC-GRM-25	3M™ PELTOR™ Communication Tip, Triple C, 25 pairs
TEP-WINDSCREEN	3M™ PELTOR™ TEP/LEP WINDSCREEN FOAM

* For further attenuation information please visit www.3M.eu/PPESafety

3M™ PELTOR™ Communication Solutions

3M™ PELTOR™ ProTac™ III Headset

The 3M™ PELTOR™ ProTac™ III hearing protector helps protect against harmful noise, whilst allowing ambient sounds to be heard at a level below 82dB. It increases your ability to communicate with nearby colleagues, as well as hearing warning signals, approaching vehicles, or sounds in machines and processes.



Features and Benefits:

- Attenuating hearing protector
- Level-dependent function for ambient listening
- 3.5 mm listen only stereo input (limited to 82 dB) for connection to external devices (e.g. cell phone, two-way radio, iPod)
- Voice guided menu system
- Auto power off: The headset will turn off after 4 hrs of non-use to save battery
- Low-battery warning at low battery level
- To reduce the corrosion caused by sweat the electronics are located in the outer part of the cup
- Available in both in headband and helmet attached versions (black)
- Available in two different cup sizes: one with higher attenuation and one slim version with lower attenuation



Attenuation*

MT13H221A 3M™ PELTOR™ ProTac™ III Headset



Frequency (Hz)	125	250	500	1000	2000	4000	8000
Mean Attenuation (dB)	17.0	24.0	28.0	36.9	37.3	39.3	35.4
Standard Deviation (dB)	3.2	2.0	29.5	3.3	4.9	3.2	3.9
Assumed Protection (dB)	13.8	22.0	2.6	33.6	32.4	36.1	31.5

EN 352-1:2002 SNR=32 dB H=34 dB M=29 dB L=22 dB

MT13H220A 3M™ PELTOR™ ProTac™ III Slim Headset

Frequency (Hz)	125	250	500	1000	2000	4000	8000
Mean Attenuation (dB)	13.3	17.4	22.3	28.0	30.8	37.6	37
Standard Deviation (dB)	3.2	1.8	2.3	3.2	3.4	2.8	4.8
Assumed Protection (dB)	10.1	15.6	20.0	24.8	27.4	34.8	32.2

EN 352-1:2002 SNR=26 dB H=29 dB M=23 dB L=17 dB

* For further attenuation information please visit www.3M.eu/PPEsafety

3M™ PELTOR™ ProTac™ III

MT13H221A Headband

Available in: Black

SNR: 32dB

Other 3M™ PELTOR™ ProTac™ III options



3M™ PELTOR™ ProTac™ III Slim Headset

MT13H220A Headband

Available in: Black

SNR: 26dB

3M™ PELTOR™ ProTac™ III Headset, black, helmet attachment

MT13H221P3E Helmet attachment

Available in: Black

SNR: 31dB

3M™ PELTOR™ ProTac™ III Slim Headset, black, helmet attachment

MT13H220P3E Helmet attachment

Available in: Black

SNR: 25dB

Battery Type: 2x AA (Alkaline)

Operating time: Approximately 1 00 hours of battery lifetime

Net Weight (Incl. Batteries): ProTac™ III Slim MT13H220A (headband) = 303g
ProTac™ III MT13H221A (headband) = 355g
ProTac™ III Slim MT13H220P3E (helmet attachment) = 322g
ProTac™ III MT13H221P3E (helmet attachment) = 374g

Operating temperature: -20°C to +55°C (battery dependent)

Wired Connectivity: 3.5mm listen-only stereo input jack (limited to 82 dB)

3M™ PELTOR™ Accessories

HY220 Hygiene kit
FL6CE/1 3M™ PELTOR™ FL6CE/1 3.5 mm Cable
HY100A 3M™ PELTOR™ HY100A CLEAN HYGIENE PAD

3M™ PELTOR™ Communication Solutions

3M™ PELTOR™ WS™ ProTac XPI

The 3M™ PELTOR™ WS™ ProTac XPI Headset is equipped with a level-dependent function for situational awareness and communication. The headset features Bluetooth wireless technology and can also be connected via a jack to provide high quality communication and streaming.

The level-dependent function helps you hear ambient sounds such as external alarm signals or approaching vehicles. It also allows face to face communication in quiet environments. Robust design, clear controls and an intuitive menu system. This is a headset you will never want to take off.



Features and Benefits:

- Protects your hearing (SNR: 31dB)
- Noise cancelling speech microphone for clear communication in noisy environments using digital noise reduction
- Stainless steel wire headband for comfortable and consistent pressure
- Bluetooth® wireless technology for communication and streaming high quality stereo sound
- Advanced voice operated transmission (VOX) technology for hands-free communication in high noise environments
- Level-dependent function for situational awareness and communication
- External radio connection jack (only available in FLEX Connector version)
- Easy to use with four button operation
- Ghost voice guided menu system
- Auto power off in 2 hours from last activation
- Also available as neckband or helmet attachment



Connects with

- Bluetooth compatible devices
- Two-way radio (Flex)



Attenuation*

MT15H7AWS6 / MT15H7AWS6-111

Frequency (Hz)	125	250	500	1000	2000	4000	8000
Mean Attenuation (dB)	14.4	24.6	35.8	36.0	34.3	35.0	34.8
Standard Deviation (dB)	3.1	1.8	3.2	2.7	2.3	3.0	3.4
Assumed Protection (dB)	11.3	22.8	32.6	33.3	32.0	32.0	31.4

SNR=31dB H=33dB. M=30dB. L=20dB

3M™ PELTOR™ Accessories

HY83	3M™ PELTOR™ HY83 Hygiene kit, 2 foam liners, 2 snap-in cushions	FR08	3M™ PELTOR™ FR08 Power supply with USB connector 7000108521	M60/2	3M™ PELTOR™ M60/2 Windshield for Level-dependent microphones 2ea
HY80	3M™ PELTOR™ Gel snap-in cushions 7000127468	FR09	3M™ PELTOR™ FR09 Battery charger with USB connector	HY100A	3M™ PELTOR™ HY100A Clean Hygiene Pad, 100pcs
ACK053	3M™ PELTOR™ ACK053 Rechargeable NiMH battery, 2100mAh	M171/2	3M™ PELTOR™ M171/2 Windshield for MT73 speech microphone 2ea	HYM1000	3M™ PELTOR™ HYM1000 Microphone protection, 5 meters

3M™ PELTOR™ WS™ ProTac XPI Headset
MT15H7AWS6 Headband
SNR: 33dB

Other 3M™ PELTOR™ WS™ ProTac XPI options



3M™ PELTOR™ WS™ ProTac XPI Headset, helmet attachment
MT15H7P3EWS6 Helmet attachment
SNR: 31dB

3M™ PELTOR™ WS™ ProTac XPI FLX2 Headset
MT15H7AWS6-111 Headband
SNR: 33dB

3M™ PELTOR™ WS™ ProTac XPI FLX2 Headset
MT15H7P3EWS6-111
Helmet attachment
SNR: 31dB

Frequency Range: 2400-2483.5 MHz

Bluetooth®

Version: 4.2+EDR

Battery Type: 2xAA NiMH or alkaline batteries, 1,2-1,5 V

Operating Time: Level Dependent + Bluetooth active: Approximately 45 hours of battery lifetime with included alkaline batteries

Net Weight, (incl. batteries): Headband:
MT15H7AWS6 = 365g
MT15H7AWS6-111 = 373g
Helmet Attachment:
MT15H7P3EWS6 = 387g
MT15H7P3EWS6-111 = 395g

Operating Temperature: -20°C to +55°C (battery dependent)

Wired Connectivity: Available with flex input jack

3M™ PELTOR™ Communication Solutions

3M™ PELTOR™ WorkTunes™ Pro Headset

The 3M™ PELTOR™ WorkTunes™ Pro Headset helps protect you from potentially harmful workplace noise while at the same time enjoy listening to the built in FM or AM/FM radio. The built-in antenna, fast digital tuning and ability to store stations makes the hearing protector flexible and easy to work with.



Features and Benefits:

- High attenuating hearing protector
- FM or AM/FM radio headset with built-in antenna
- Digital station search
- Voice guided menu system with announced frequencies
- Store up to 5 stations
- 3.5mm listen only stereo input (limited to 82dB) for connection to external devices (e.g. cell phone, two-way radio, iPod)
- Auto power off, the headset will turn off after 4hrs of non-use to save battery
- Low-battery warning at low battery level
- To reduce the corrosion caused by sweat the electronics are located in the outer part of the cup
- Available in both in headband and helmet attached versions (black)



Attenuation*

HRXS221A and HRXS220A EN 352-1:2002

Frequency (Hz)	125	250	500	1000	2000	4000	8000
Mean Attenuation (dB)	17.0	24.0	29.5	36.9	37.3	39.3	35.4
Standard Deviation (dB)	3.2	2.0	2.6	3.3	4.9	3.2	3.9
Assumed Protection (dB)	13.8	22.0	26.9	33.6	32.4	36.1	31.5

SNR=32 dB H=34 dB M=29 dB L=22 dB

HRXS221P3E and HRXS220P3E EN 352-3:2002

Frequency (Hz)	125	250	500	1000	2000	4000	8000
Mean Attenuation (dB)	16.6	22.0	29.1	36.3	36.4	38.7	34.2
Standard Deviation (dB)	2.7	2.2	2.9	3.4	3.9	4.2	4.0
Assumed Protection (dB)	2.7	2.2	2.9	3.4	3.9	4.2	4.0

SNR=31 dB H=33 dB M=28 dB L=21 dB

* For further attenuation information please visit www.3M.eu/PPEsafety

3M™ PELTOR™ WorkTunes™ Pro FM Radio Headset

HRXS220A Headband

Available in: Black

SNR: 32dB

Other 3M™ PELTOR™ WorkTunes™ Pro FM Radio Headset options



3M™ PELTOR™ WorkTunes™
Pro FM Radio Headset
HRXS220P3E Helmet
attachment

Available in: Black
SNR: 31dB

3M™ PELTOR™ WorkTunes™
Pro AM/FM Radio Headset
HRXS221A Headband
Available in: Black
SNR: 32dB

3M™ PELTOR™ WorkTunes™
Pro AM/FM Radio Headset
HRXS221P3E Helmet
attachment
Available in: Black
SNR: 31dB

Battery Type:	2x AA (Alkaline)
Operating time:	Approximately 40 hours of battery lifetime
Net Weight (incl. batteries):	WorkTunes Pro FM HRXS220A (headband) = 351g WorkTunes Pro FM HRXS220P3E (helmet attachment) = 369g WorkTunes Pro AM/FM HRXS221A (headband) = 353g WorkTunes Pro AM/FM HRXS221P3E (helmet attachment) = 371g
Operating temperature:	-20°C to +55°C (battery dependent)
Wired Connectivity:	3,5 mm AUX input jack (limited to 82dB(A))
3M™ PELTOR Accessories	
HY220	Hygiene kit
FL6CE/1	3M™ PELTOR™ FL6CE/1 3.5 mm Cable
HY100A	3M™ PELTOR™ HY100A CLEAN HYGIENE PAD

3M™ PELTOR™ Communication Solutions

3M™ PELTOR™ WS™ Alert™ XP Headset

With the 3M™ PELTOR™ WS™ Alert™ XP Level Dependent FM-Radio Bluetooth® Headset, we introduce a new era in the world of hearing protection. With a built-in FM-radio receiver, Bluetooth® and a level dependent technology for situational awareness, 3M PELTOR WS Alert XP enables users to have wireless telephone conversations or listen to their favourite music even in noisy environments.



Features and Benefits:

- High attenuating hearing protector in two models: stand-alone headband or safety helmet attachment (SNR 30dB)
- Bluetooth® Technology for connection to one external device for hands-free talk and streaming
- Noise cancelling boom microphone for clear speech transmission in noisy environments
- Level-dependent function for ambient listening to help improve your situational awareness
- Auto-pairing to quickly pair and connect to your mobile device
- Built-in FM-Radio with radio volume limited to 82dB
- Voice guided menu system
- Digital station search with ability to store up to 4 favourite stations
- Auto power off: The headset will turn off after 4 hrs of non-use to save battery
- Low-battery warning at low battery level
- Electronics located in the outer part of the cup to reduce corrosion caused by sweat
- Rechargeable option with NiMH batteries
- Replaceable cushions and foam liners



Attenuation*

MRX21A2WS6 EN352-1:2002



Frequency (Hz)	125	250	500	1000	2000	4000	8000
Mean Attenuation (dB)	13.8	19.3	30.4	34.5	37.7	39.5	36.2
Standard Deviation (dB)	2.7	2.4	3.6	3.6	2.3	2.7	4.1
Assumed Protection (dB)	11.1	16.9	30.9	30.9	35.4	36.8	32.1

SNR= 30dB H=35 dB M=27 dB L=18 dB

MRX21P3E2WS6 EN352-3:2002

Frequency (Hz)	125	250	500	1000	2000	4000	8000
Mean Attenuation (dB)	14.2	19.7	29.6	33.4	36.3	39.5	34.6
Standard Deviation (dB)	3.9	1.9	2.5	1.8	2.5	2.7	4.9
Assumed Protection (dB)	10.3	17.8	27.1	31.6	33.8	36.8	29.7

SNR= 30dB H=34 dB M=27 dB L=18 dB

* For further attenuation information please visit www.3M.eu/PPESafety

3M™ PELTOR™ WS™ Alert™ XP
MRX21AWS5 Headband
SNR: 29dB

Other 3M™ PELTOR™ WS™ Alert™ XP options



3M™ PELTOR™ WS™ Alert™ XP
MRX21P3EWS5 Helmet attachment
SNR: 31dB

Battery Type: 2X AA 1.2–1.5 V

Operating time: Approximately 23 hours of battery lifetime with included alkaline batteries (all functions active)

Net Weight (incl. batteries): 430 g (headband)
455 g (helmet att.)

Operating temperature: -20°C to +55°C (battery dependent)

Wired Connectivity: 3,5 mm AUX input jack (limited to 82dB(A))

3M™ PELTOR™ Accessories

HY81 Hygiene kit
FL6CE/1 Connection cables for external audio input
LR6NM Rechargeable AA batteries
FR08 Power supply
FR09 Battery charger

3M™ PELTOR™ Communication Solutions

3M™ PELTOR™ WS™ ALERT™ XPI Headset

The 3M™ PELTOR™ WS™ ALERT™ XPI Headset is the next generation protective communication solution. With Bluetooth® wireless communication, noise-cancelling boom microphone, integrated FM Radio and level-dependent function for ambient listening, the WS™ ALERT™ XPI Headset not only helps protect you against hazardous noise, but also makes it easy to make phone calls with both hands free in noisy environments.

The new 3M™ Connected Equipment App will allow you to control your settings from your mobile phone.

Features and Benefits:

- High attenuating hearing protector in two models: stand-alone headband or safety helmet attachment (SNR 30 dB)
- Control all your settings (radio station, streaming, phone calls) from your mobile phone via Bluetooth®
- Mobile application : easy headset set-up and controlling via 3M™ Connected Equipment App (IOS and Android)
- Noise cancelling boom microphone for clear speech transmission in noisy environments
- Level-dependent function for ambient listening to help improve your situational awareness (limited to 82 dB)
- Push-to-Listen feature to easily and instantaneously listen to your surroundings
- Built-in FM-Radio with radio volume limited to 82dB
- Voice guided menu system with announced FM-Radio frequencies
- Digital station search
- Ability to store up to 4 favourite stations
- Auto power off: The headset will turn off after 4 hrs of non-use to save battery



Attenuation* MRX21A3WS6

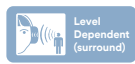

Frequency (Hz)	125	250	500	1000	2000	4000	8000
Mean Attenuation (dB)	13.8	19.3	30.4	34.5	37.7	39.5	36.2
Standard Deviation (dB)	2.7	2.4	2.7	3.6	2.3	2.7	4.1
Assumed Protection (dB)	11.1	16.9	27.7	30.9	35.4	36.8	32.1

SNR=30dB. H=35dB. M=27dB. L=18dB

3M™ PELTOR™ accessories:

HY82	Hygiene kit	M995/2	Wind shield for speech microphone
FR08 3	Power supply with USB connector	HY100A	Clean hygiene pad
FRO9	Battery charger with USB connector	HYM1000	Microphone protection
LR6NM	Rechargeable AA batteries		

* For further attenuation information please visit www.3M.eu/PPEsafety

3M™ PELTOR™ WS™ ALERT™ XPI

MRX21A3WS6 headband
SNR: 30dB
SNR: 29dB

Other 3M™ PELTOR™ WS™ ALERT™ XPI options



3M™ PELTOR™ WS™ ALERT™ XPI
MRX21P3EWS6 helmet attachment
SNR: 30dB

3M™ PELTOR™ WS™ ALERT™ XPI
ACK (FR09, FR08, LR6NM), headband
SNR: 30dB

3M™ PELTOR™ WS™ ALERT™ XPI
MRX21P3EWS6-ACK, incl. ACK (FR09, FR08, LR6NM), helmet attachment
SNR: 30dB

Battery Type: 2x AA (Alkaline)
Operating time: Approximately 58 hours (FM radio and level-dependent)

Approximately 78 hours (Bluetooth® streaming and level-dependent)

Net Weight (incl. batteries): MRX21AWS6 (headband): 411 g
MRX21P3EWS6 (helmet attachment): 431 g

Bluetooth® Technology: Bluetooth version: 4.2

Bluetooth® Range: Up to 10m (class 2)

Speakers: 27 mm diameter, 100 Ohm

Boom microphone type: Noise cancelling electret microphone

Operating temperature: -20°C (-4°F) to +55°C (131°F) (battery dependent)

Storage temperature: -20°C (-4°F) to +55°C (131°F)

Shelf life: 5 years excl. batteries

3M™ PELTOR™ Communication Solutions

3M™ PELTOR™ LiteCom

With 3M™ PELTOR™ LiteCom communicating in noisy environments has been made easy – and safe. LiteCom is a tough and rugged headset designed to cope with demanding use in many different working environments.

The built-in two-way radio has got 8 channels with 38 subchannels, and has a range of up to 3 km. It lets you talk hands-free and work safely regardless of harmful noise levels.



Features and Benefits:

- Protects your hearing (SNR: 32dB)
- Built in two-way radio
- 8 channels in the PMR 446 MHz band
- 38 subchannels
- Range of up to 3 km depending on conditions
- Voice operated transmission (VOX)
- Auto power off function
- Battery status indication
- Voice guided menu system
- Also available as neckband or helmet attachment



3M™ PELTOR™ LiteCom
MT53H7A4400-EU Headband
SNR: 32dB

Other 3M™ PELTOR™ LiteCom options



3M™ PELTOR™ LiteCom
MT53H7B4400-EU Neckband
SNR: 32dB



3M™ PELTOR™ LiteCom
MT53H7P3E4400-EU Helmet attachment
SNR: 33dB

Frequency range: 446 MHz (PMR)

Battery Type: 2X AA 1.2–1.5 V batteries or NiMH (2,4 V)

Operating time: Approximately 20 hours of battery lifetime with included alkaline batteries

Net Weight (incl. batteries): 394g (headband)
418g (helmet att.)
384g (neckband)

Operating temperature: -20°C to +55°C (battery dependent)

Attenuation*
MT53H7A4400-EU Headband



Frequency (Hz)	125	250	500	1000	2000	4000	8000
Mean Attenuation (dB)	18.1	24.3	32.1	36.2	34.7	39.2	36.0
Standard Deviation (dB)	2.4	1.7	2.2	2.6	3.6	3.3	2.4
Assumed Protection (dB)	15.6	22.6	29.9	33.6	31.1	35.9	33.6

SNR=32dB H=33dB, M=30dB, L=23dB

* For further attenuation information please visit www.3M.eu/PPESafety

3M™ PELTOR™ Accessories
HY79 Hygiene kit
ACK053 Rechargeable battery
FR08 Power supply
FR09 Battery charger
MT53N-12 Electret microphone

3M™ PELTOR™ Communication Solutions

3M™ PELTOR™ WS™ LiteCom Plus

3M™ PELTOR™ WS™ LiteCom Plus with Bluetooth® opens up a world of communication with your built-in two-way radio headset at the hub. You become a mobile, hands-free communication center, the built-in two-way radio and wireless connections to your computer and cell phone. You can take your calls, or stream music thanks to electronics that let you switch easily between functions. The level-dependent technology lets you hear ambient sounds such as external alarm signals or approaching vehicles. It also allows face to face communication at close distance. Robust design (IP54 certified), clear controls and an intuitive menu system. This is a headset you will never want to take off.



Features and Benefits:

- Protects your hearing (SNR: 35dB)
- Built in two-way radio communication
- Connect different devices (radio, mobile phone) via Bluetooth® Multi-Point connection
- 8 channels in the PMR 446 MHz band and 69 subchannels
- IP54 certified
- Range of up to 3 km depending on conditions
- Level dependent technology for situational awareness
- A separate audio input enables connecting equipment such as mobile phones or external two-way radios.
- Voice operated transmission (VOX)
- Auto power off function
- Voice guided menu system
- Noise cancelling waterproof microphone (IP68)

Connects with

- Bluetooth compatible devices
- Two-way radio (Via Flex cable or Bluetooth®)



Compatible with HY-80 Gel rings (option)

Attenuation*

MT73H7A4410WS6EU Headband



Frequency (Hz)	125	250	500	1000	2000	4000	8000
Mean Attenuation (dB)	17.1	25.6	34.5	34.5	36.6	36.9	37.3
Standard Deviation (dB)	2.4	1.2	3.0	2.8	2.1	3.0	3.1
Assumed Protection (dB)	14.7	24.4	31.5	31.7	34.5	36.6	35.2

SNR=33dB H=35dB. M=31dB. L=24dB

3M™ PELTOR™ WS™ LiteCom Plus
MT73H7A4410WS6EU Headband
SNR: 35dB

Other 3M™ PELTOR™ WS™ LiteCom Plus options



3M™ PELTOR™ WS™ LiteCom Plus
MT73H7B4410WS6EU
Neckband
SNR: 31dB



3M™ PELTOR™ WS™ LiteCom Plus
MT73H7P3E4410WS6EU
Helmet attachment
SNR: 31dB

Frequency range: PMR 446MHz or LPD 433MHz

Bluetooth® Version: 2.1+EDR

Battery Type: Rechargeable battery pack included or 2x standard AA batteries

Operating time: Approximately 18 hours

Net Weight (incl. batteries): 449g (headband)
434g (helmet att.)
434g (Neckband)

Operating temperature: -20°C to +50°C (battery dependent)

3M™ PELTOR™ Accessories

ACK081 Battery
FR08 Power supply
ACK081 Cable AL2AI
HY83 Hygiene kit
HY80 Gel Rings
HYM1000-100 Mic Tape

* For further attenuation information please visit www.3M.eu/PPEsafety



Head, Eye and Face Protection





Integrated Head and Face Solutions

3M™ Head and Face Solutions

The 3M brand offers a complete line of safety helmets, bump caps, face shields, combinations and accessories for anyone exposed to hazardous environments. Our goal is continuous improvement of our products to provide the optimal balance of comfort and safety.

3M™ Head and Face Protection

3M™ Uvicator™ Technology for safer working conditions

When a safety helmet is exposed to sunlight the stability of the plastic shell may be adversely affected due to interaction between UV-radiation and the plastic material which may weaken the helmet and compromise safety of the wearer. The adverse effect is dependent not only on the nature of the plastic material but also the intensity of the UV-radiation. All too often damage to the helmet shell may not be visible to the naked eye.

Red, the new sign of safety

The patented Uvicator technology is intended to easily and clearly help show the user when his/her helmet has been over-exposed to UV-radiation and thus when to replace it. This technology is the result of many years of full scale and artificial ageing testing of different material combinations under various sunlight exposure conditions.

As the helmet is exposed to sunlight, the Uvicator indicator is calibrated to detect the amount of UV radiation received and gradually changes colour over time, clockwise, from red to white. When the Uvicator indicator turns completely white, it means that the helmet has received maximum tolerable radiation and therefore needs to be replaced.



Measures exposure to UV radiation



Technically calibrated and tested



Works globally in most environments



Tells you when to replace your helmet



3M™ Head and Face Protection

3M™ SecureFit™ Safety Helmets

The new 3M™ SecureFit™ Safety Helmet is a climbing-style helmet that delivers all-day comfort without sacrificing security. From our proprietary design to our industry-leading innovations, the 3M™ SecureFit™ Safety Helmet is engineered by safety experts with workers in mind. The result is a revolutionary helmet design that delivers what workers need. Comfort without compromise.



Features and Benefits:

- Suspension system incorporates exclusive patented Pressure Diffusion Technology
- 4-point or 6-point ratchet suspension allows wearer to customise height and fit
- Proprietary UV indicator that lets wearer know when to replace helmet due to UV exposure
- Vented helmets are certified to either EN 12492 or EN 397 (depending on chin strap configuration), as well as EN 50365 1000 V standard
- Climbing helmet-inspired design
- Customise your fit with multiple levels of vertical adjustment
- Works with a variety of 3M faceshields, earmuffs, and other accessories
- Optional vents



3M™ SecureFit™ Safety Helmet X5000 Series

- Ventilation with optional reflective strips
- 4-point chin strap selector system unique to 3M allows wearer to convert between EN 12492 and EN 397 standards. Certified to EN 12492, EN 397, and EN 50365 (1000Vac).*
- Available in 8 colours



3M™ SecureFit™ Safety Helmet X5500 Series

- Optional ventilation on sides and back
- Certified to EN 397 and EN 50365 (1000Vac)** standards
- Available in 8 colours



Customisable

A variety of 3M accessories are available to meet specific job requirements.



Accessory slots

Accessory slots designed to hold 3M earmuffs and communication products.



Elastic band clips

Integrated clips help hold elastic bands used with 3M goggles and headlamps.



Removable sweatband

Sweatbands can be removed and washed, or replaced with sweatband replacement accessory.



*Depending on chin strap configuration. Not reflective if 1000Vac.

**Not to be used with reflective material or magnetic buckle chin strap.

3M™ Head and Face Protection

3M™ Safety Helmet G3000 Series

The G3000 helmet has been developed and designed in close collaboration with industrial and forestry workers. It is intended for use in harsh environments with tough demands for effective protection. The G3000 has excellent ventilation, good field of vision and is one of few lightweight helmets available on the market today.

Now available with Scotchlite™ reflective material. Adding Scotchlite™ reflective material can help provide additional high visibility performance in low light to help workers be seen so they can function at their best.

Industrial Safety helmet G3000 is now available with reflective materials in a range of colours to suit your head protection needs.

Features and Benefits:

3M™ Uvicator™ Sensor

- The disc tells you when it's time to replace your helmet

Ventilation

- Optimised ventilation with lots of ventilation holes

Slim design

- Softly rounded design, which helps to avoid helmet parts snagging on branches etc.

Reversible lining

- Lining that can be rotated 180° allows the helmet to be worn back-to-front which is ideal, for example, when working in tight spaces or climbing

Ratchet headband

- For easier and quicker adjustment

Accessories

- Attachment point for accessories

Sweatband

- Easy to replace for increased comfort
Available in plastic or leather

Space for company name

- Surface for printing a logo, brand name, etc.

Short brim

- Short brim giving a broader field of view

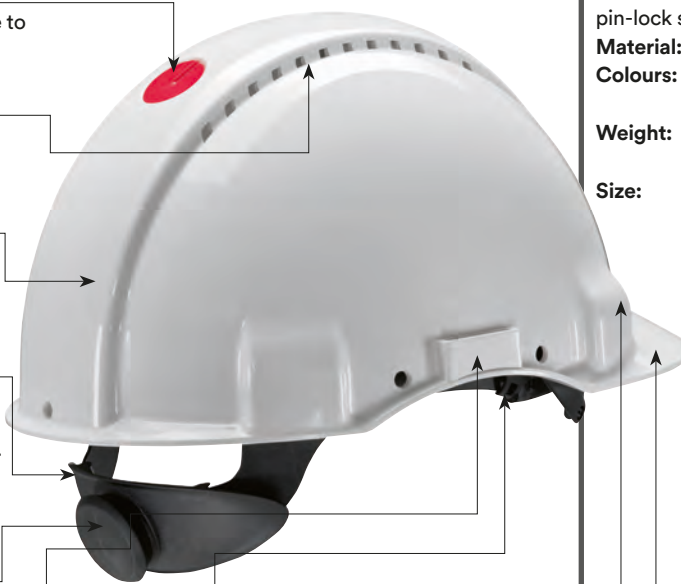

3M™ G3000 Series Helmets

Available in 8 colours with ratchet or pin-lock suspension

Material: UV-stabilised ABS

Colours: yellow, white, orange, red, blue, green, Hi-Viz and black

Weight: 310g (pin-lock)

334g (ratchet)

Size: 54-62cm for pin-lock version



Now available with reflective strips.

For features and benefits on the reflective strips please refer to **page 118**.



3M™ Forestry Helmet Combination

Ready-to-use combination for forestry workers
Includes: G3000 helmet, V4CK mesh visor, H31P3E ear muffs, GR3C rain protection

The characteristics of the G3000 helmet are:

Offers excellent protection and approved against EN 397, with the following additional approvals:

- **G3000**
low temperature, -30°C, and molten metal, MM
- **G3001**
(unventilated): low temperature, -30°C, molten metal, MM, and electrical insulation 440Vac,

- **G3001 1000V**
(unventilated): same as G3001 with additional approval according to EN 50365, for electrical insulation at 1000Vac
- **G3000-10**
(with lamp and cord holder) low temperature, -30°C and molten metal, MM

3M™ Head and Face Protection

3M™ Safety Helmet G3501 Series

Temperature extremes, metal sparks and splashes – that’s the job. And it’s a tough environment to work in. You just can’t afford to compromise the safety and comfort of your workforce.

At 3M we recognise the demanding nature of the work you and your team undertake every day. That’s why we’ve developed a range of completely compatible personal protective equipment (PPE) that can help provide the necessary safety, comfort and compliance in the work environment

Features and Benefits:

- Lightweight and durable helmet meeting a wide range of standard performance requirements
- Electrically insulating in accordance with EN50365 for live-working in low voltage environments
- Approved for use at temperatures ranging from -30°C to +150°C



3M™ Safety Helmet G3501

Available in 6 colours with ratchet suspension

Material: glass fibre reinforced nylon

Colours: yellow, white, orange, red, blue and green

Weight: 392g (ratchet)

Size: 54-62cm for pin-lock version
53-62cm for ratchet version



Select a combination for a complete solution:

3M™ Face Shields



5XG-IR5 Gold/Green visor shade 4-5, medium energy impact (B), Molten Metal Splash (9)



5F-11 Clear visor shade 2C-1.2, medium energy impact (B), liquid splash (3), electric arc (8)



5E-11 Green Image Shade 5, medium energy impact (B), liquid splash (3)



3M™ V9 Integrated Eyewear

The design allows the glasses to slide easily between the head cradle and carrier. Available in clear, yellow and grey

Additional heat protection



NC1-GR Cotton/Para-aramid neck cover for flame resistance and metal splash resistance

FC1-GR Cotton/Para-aramid front cover to protect the helmet from flames and metal splash



NC1-AL Aluminised fabric neck cover offering flame, splash and IR resistance to the wearer’s neck

FC1-AL Aluminised fabric front cover offering flame, splash and IR resistance to the helmet and wearer



Hearing Protection and Communication Headsets

3M™ PELTOR™ X Series Earmuffs X4P3E Compatible with a wide range of Earmuffs including the 3M™ PELTOR™ X Series and 3M™ Optime™ Series. A wide range of Communication headsets including 3M™ PELTOR™ LiteCom

3M™ Head and Face Protection

3M™ Safety Helmet G2000 Series

Attractive design and excellent protection! That's the easiest way to summarise the G2000 helmet. The helmet fulfils the requirements for formal testing and is comfortable with its low back and relatively low profile.

It was designed to accommodate additional accessories, such as integrated eyewear, visor and hearing protection.

Features and Benefits:

Ventilation

- For comfort, good ventilation is a must, particularly in warm environments. The G2000 Helmet allows free airflow between the helmet and its harness. Combined with ventilation inlet in the top of the helmet, this helps to increase wearers acceptance

3M™ Uvicator™ Technology

- The disc tells you when it's time to replace your helmet

Optional space for customised print

- A flat surface for printing a logotype, brand name, etc.

Neck protection

- Extended edge on the back of the helmet provides extra coverage for the sensitive neck area

Ratchet headband

- For easier and quicker adjustment

Optimal profile for ear muffs

- The G2000 helmet features a special profile design to enable helmet mounted ear muffs to achieve optimal fit and maximum adjustability for individual needs

Attachment point for accessories

- An adjustable snap attachment in the balance point of the helmet to allow simple attachment of accessories, such as muffs, headsets and visors

Sweatband

- Easy to replace for increased comfort and hygiene. Also available in soft leather



3M™ G2000 Series Helmets

Available in 7 colours, with ratchet or pin-lock suspension

Material: UV-Stabilised ABS

Colours: yellow, white, orange, red, blue, green and Hi-Viz

Weight: 354g (pin-lock)

376g (ratchet)

Size: 54-62cm for pin-lock version
53-62cm for ratchet version

Other 3M™ Head Protection Products



3M™ Industrial Helmet Combination

Di-electric combination specially designed for work in electrical environments
Includes: G2001 helmet, H31P3K-01 ear muffs, V4H clear visor.



3M™ V9 Integrated Eyewear

Designed to be used with 3M™ Helmets. The design allows the glasses to slide easily between the helmet shell and lining. Available in clear, yellow, grey



3M™ Helmet Accessories

A wide range of accessories are available, including sweatbands, chin straps, rain protection, etc...

3M™ Head and Face Protection

3M™ Safety Helmet H700 Series

The 3M™ Safety Helmet H700 is comfortable but tough. Designed with a low profile for improved stability and performance, the H700 Series is engineered to provide ultimate full-shift comfort without compromising the protection against small objects striking the top of the hard hat.

Now available with Scotchlite™ reflective material. Adding Scotchlite™ reflective material can help provide additional high visibility performance in low light to help workers be seen so they can function at their best.

Industrial Safety helmet H700 is now available with reflective materials in a range of colours to suit your head protection needs.

Features and Benefits:

Cool wear

- Ventilated headband
- Optional ventilated shell

Ease of Use

- Short brim for better upward visibility and user mobility
- Replaceable sweatband

Internal Accessory slots for:

- 3M™ Helmet Mounted Earmuffs
- 3M™ Helmet Mounted Communication Solutions
- Integrated Eyewear
- Face Shields
- Welding helmets

Suspension

- Comfortable 4 point pin-lock or ratchet suspension with height adjustment or an optional 6 point strap



3M™ Industrial Safety Helmets with Reflectives

Safety

- Carefully selected 3M adhesive technology to ensure the performance of the helmet is maintained with the addition of reflective properties.

Precision

- Factory applied for accurate positioning to ensure the best visibility for the kit.

Visibility

- Designed to improve visibility and safety of the worker in low light conditions.

Recognition

- Designed to provide visibility of the reflective when viewed from all lateral directions and from above.

3M™ Helmet H700 Vented option

Available in 6 colours with ratchet or pin-lock suspension

EN397:2012 + A1:2012

Very low temperature (-30°C)

3M™ Helmet H701 Non-vented option

Available in 6 colours with ratchet or pin-lock suspension

EN397:2012 + A1:2012

Very low temperature (-30°C)

Molten metal splash (MM)

Electrical insulation (440 Vac)

Also meet the requirements for low temperature (-50°C) according to OCT P EH 397/A1-2010

Material: high density polyethylene

Colours: yellow, white, orange, red, blue and green

Weight: 356g (pin-lock)

378g (ratchet)

Size: 54-62cm for pin-lock version

53-62cm for ratchet version



Now available with reflective strips.

3M™ Head and Face Protection

3M™ Headgear G500 Series

The 3M™ Headgear G500 is a versatile and comfortable solution for use as a standalone face protection system or for combined face and hearing protection. Special design features make it easy to combine the G500 with other 3M™ Safety Products such as face shields, passive earmuffs or

communication headsets and integrated eyewear. This high quality product provides protection against impacts from the front and side, while special attention at the design stage has ensured maximum visibility and wearer comfort.

Features and Benefits:

Front cover

- Ventilation for increased comfort
- Design incorporates a cable holder for PELTOR Communication products

Face Shield

- A wide range of visors and face shields available for many industrial applications
- Offers a wide field of view

Integrated eyewear

- To increase eye protection G500 headgear can incorporate integrated eyewear
- Available in clear, grey and yellow

Ratchet Harness

- Ergonomically designed neck support gives maximum comfort for long periods of time
- 3 height adjustment positions
- 8 head size adjustments

Robustness

- Firm and sturdy for improved product life
- Reduction of flexible materials minimises stress and deformation caused by rough handling
- Ensures consistent attenuation when combined with hearing protection or communication headsets

Hearing Protection

- G500 can be used with or without earmuffs
- 30mm slot fits the PELTOR P3E-earmuff attachment



3M™ Industrial Combination G500
 3M™ Headgear G500
 Clear PC Face Shield 5F-11
 3M™ PELTOR™ Optime™ I Earmuffs



3M™ Forestry Combination G500
 3M™ Headgear G500
 Stainless Steel Mesh Face Shield 5C-1
 3M™ PELTOR™ Optime™ I Earmuffs

3M™ V9 Integrated Eyewear
 Designed to be used with 3M™ Headgear G500. The design allows the glasses to slide easily between the head cradle and carrier. Available in clear, yellow and grey



3M™ Face Shields
 The wide range of visors allows for many industrial combinations

Mesh Face Shield 5B/5C-1/5J-1
 Available in Polyamide, Stainless steel and Etched metal mesh.
 EN1731:2006 Approved



Polycarbonate Face Shield 5F-11/5E-11
 Available in clear and Shade 5
 EN166:2001 Approved
 5F-11 (2C-1.2 3M 1 B 3)
 5E-11 (5 3M 1 B 3)



3M™ Head and Face Protection

3M™ Helmet Linkage System V5

The 3M™ Linkage System V5 can be mounted onto the 3M™ Industrial Safety Helmet G22 or G3000 to allow attachment of a range of faceshields. This high quality product provides protection against impacts from the front and side.

Features and Benefits:

Face Shield

- A wide range of visors and faceshields available for many forestry and industrial applications
- Offers a wide field of view
- Designed to attach to helmet via a wide range of 3M™ PELTOR™ Earmuffs with helmet adapter
- New 'Snap-in' feature makes it easy to combine the faceshield to the linkage system

Integrated Eyewear

- To increase eye protection the V5 can incorporate integrated eyewear
- Available in clear, grey and yellow

Robustness

- Firm and sturdy for improved product life
- Reduction of flexible materials minimises stress and deformation caused by rough handling
- Ensures consistent attenuation when combined with hearing protection or communication headsets



3M™ Helmet Linkage System



3M™ Forestry Combination
G3000NOR31V5C
3M™ Industrial Safety
Helmet G3000
Stainless Steel Mesh
Faceshield 5C-1
3M™ Earmuffs H31



Mesh Face Shield
5B/5C-1/5J-1
Available in Polyamide,
Stainless steel and Etched
metal mesh.
EN1731:2006 Approved

Polycarbonate Face Shield
5F-1/5E-1
Available in clear and
Shade 5
EN166:2001 Approved
5F-1: 2C-1.2 3M
1:A(BT):3:8:9:K:N
5E-1: 5 3M 1:BT:3:9:K:N

3M™ Head and Face Protection

3M™ Helmet Integrated Safety Glasses V9 Series

The 3M™ Helmet Integrated Safety Glasses V9 Series is a range of integrated safety eyewear designed to attach to the headband of 3M™ Helmet or Headgear products.

Features and Benefits:

The 3M™ Helmet Integrated Safety Glasses V9 Series are designed to be fitted to the following 3M™ products:

- 3M™ G500 Headgear
- 3M™ G22 Industrial Safety Helmet
- 3M™ G2000 Industrial Safety Helmets
- 3M™ G3000 Industrial Safety Helmets
- 3M™ G3501 Industrial Safety Helmets
- 3M™ H700 Industrial Safety Helmets

Comfort

- Features an easy to use clip-on attachment to connect to the headband of the helmet or headgear
- Features 3 pivoting adjustment points allowing for easy positioning to a range of face shapes and sizes. In order to assess the fit of safety eyewear we recommend the 3M™ eyewear fit system

Possible adjustments include:

- Up and down
- Forwards and backwards
- Angle up and down
- The adjustment mechanism also allows the safety glasses to be stored inside the helmet to protect it from damage during storage or when eye protection is not required
- The safety glasses can be used at the same time as faceshields when continuous eye protection is required but faceshields are not in constant use
- Designed without temple arms the helmet integrated safety glasses will not interfere with the acoustic seal of helmet mounted Ear Muffs



V9C: Helmet integrated safety glasses

Lens Colour: Clear
Lens: Polycarbonate
Spectacle arms: Polyamide
Nosepad: Thermoplastic rubber



V9A: Helmet integrated safety glasses

Lens Colour: Amber
Lens: Polycarbonate
Spectacle arms: Polyamide
Nosepad: Thermoplastic rubber



V9B: Helmet integrated safety glasses

Lens Colour: Grey
Lens: Polycarbonate
Spectacle arms: Polyamide
Nosepad: Thermoplastic rubber

3M™ First Base™ + Bump Cap

Putting safety at the top.

Get light-duty head protection with 3M™ First Base™ + Bump Caps. Ideal for workers in automotive, aerospace, food processing or transport and logistic industries.

Features and Benefits:

- Ventilation
- Absorbent terry toweling sweatband
- Low profile design provides protection to EN 812
- Compressed closed cell foam pad
- Flexible shell made with ABS plastic, can be removed for cleaning
- Available in different peak lengths for a variety of applications
- Optional logo customisation areas



Adjustable elastic strap for a personal fit

3M™ First Base™ + Bump Cap Navy Blue Standard Peak (70 mm)

Also available in:

- Reduced Peak (55 mm)
- Micro Peak (25 mm)

3M™ First Base™ + Bump Cap Grey Standard Peak (70 mm)

Also available in:

- Reduced Peak (55 mm)
- Micro Peak (25 mm)



3M™ First Base™ + Bump Cap Black Standard Peak (70 mm)

Also available in:

- Reduced Peak (55 mm)



3M™ First Base™ + Bump Cap Royal Blue Standard Peak (70 mm)

Also available in:

- Reduced Peak (55 mm)







Protective Eyewear Solutions

The portfolio of 3M™ Eye Protection products promises quality eyewear that provides an optimal balance of comfort, protection and design.

3M's Engineers have worked hard to ensure that the level of comfort and style matches the standard of protection offered. The 3M portfolio offers the highest level of optical class. A broad range of eyewear products include anti-scratch, anti-fog/anti-scratch or optional Scotchgard™ Anti-Fog/Anti-Scratch Coatings. All products are approved to EN166 and are CE marked.

3M™ Protective Eyewear

3M™ Eyewear Fit System

As with all personal protective equipment, comfort is very closely linked with compliance and improperly fitted eyewear may not be enough to prevent eye injuries, so the quality and security of fit is extremely important. Unlike respiratory protection where face fit testing is mandatory, there are no regulatory requirements regarding fitting of eyewear. While current standards suggest careful consideration should be given to eyewear fit, e.g. BS 7029:1999, there is no specific guidance on how to evaluate an individual's fit. Making an assessment based on size and adjustable features is not always adequate to determine best fit and security of eyewear. The innovative 3M™ Eyewear Fit System, is a simple 6 step method* and enables a measured evaluation of fit. This method, utilising the Coverage and Gap gauge tools will help assess 4 elements of protective eyewear fit:

View

Assessment to ensure the wearer can see in all directions of eye rotation without major obstruction to the field of view that would interfere with visibility to perform work tasks.

Coverage

The Coverage gauge assesses how well the safety eyewear covers the soft tissue area around the eyes.

Security

Assessment to ensure the eyewear stays in place on the wearer's head and does not fall off with head movement.

Gaps

The Gap gauges help to identify excessive gaps between the eyewear and the face. Large gaps can provide a clear path for flying debris.

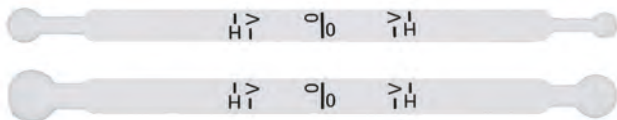
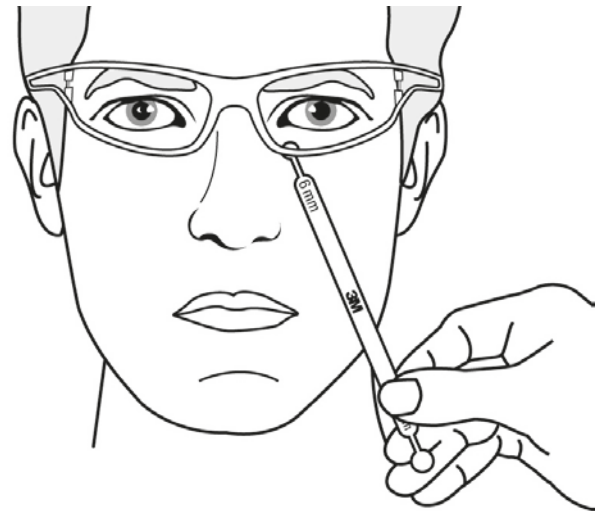
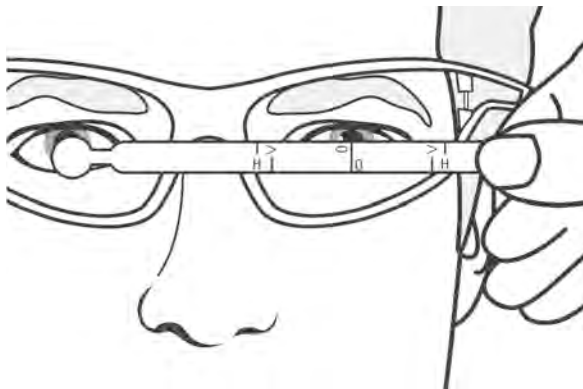

* The full 6 step method is unique to 3M and is available free of charge (Subject to terms and conditions, see website for details). Find out more by contacting your 3M Personal Safety Sales Representative or visit www.3M.eu/eyewear

3M™ Protective Eyewear

3M™ SecureFit™ Safety Glasses 200 Series

Recognising that lack of comfort and fit are the biggest barriers to protective eyewear use, 3M has introduced a revolutionary range of safety eyewear which self-adjusts to individual head sizes, delivering noticeably higher levels of personal comfort and security of fit. Weighing just 18g, the lightweight eyewear has no moving parts. It simply adjusts to fit a wide array of head sizes, reducing the need to stock

multiple frame sizes. The new 3M™ SecureFit™ Protective Eyewear features patented 3M™ Pressure Diffusion Temple Technology which draws on years of scientific anthropometric research by 3M. This game-changing technology allows the frames to naturally adjust to the wearer's profile, providing a snug, stylish and secure fit across a diverse workforce, without compromising safety.

Features and Benefits:

Style

- Sleek, streamline design
- The robust temple design gives great performance and make adjustable features redundant

Premium Protection

- Provides complete impact protection for the orbital region of the eye
- Exceeds the requirements of EN166 clause 7.2.8 Lateral Protection
- Integrated side-shield provides additional protection for surrounding tissues
- 3M™ Scotchgard™ Anti-Fog/Anti-Scratch Coating resists fogging longer than traditional coatings, even after multiple washes

Comfort

- Features 3M™ Pressure Diffusion Temple Technology
- Constant temple force even with different head sizes
- Reduced frame slippage during workplace head movements
- Self adjusting temples for a secure fit
- Weighs only 18g

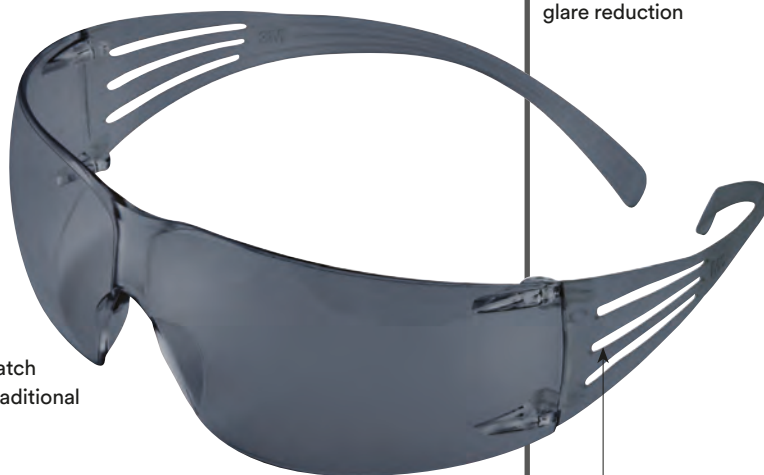

3M™ SecureFit™ Classic Line Safety Glasses SF202AF

Lens colour: grey
Optical Class 1
5C-3.1 lens provides UV protection and glare reduction



3M™ SecureFit™ Classic Line Safety Glasses SF203AF
Lens colour: amber



3M™ SecureFit™ 200 Safety Glasses SF201SGAF-BLU
Lens colour: Clear



3M™ SecureFit™ Classic Line Safety Glasses SF201AS
Lens colour: clear



3M™ SecureFit™ Classic Line Safety Glasses SF201AF
Lens colour: clear

3M™ Protective Eyewear

3M™ SecureFit™ Safety Glasses 400 Series

Sourcing eyewear to securely fit a diverse workforce can be a challenge. 3M Pressure Diffusion Temple Technology enhances fit as temples naturally adjust to individual head sizes. This can result in enhanced comfort due to less pressure over the ears without compromising security of fit.

This lightweight eyewear weighs just 19g and offers improved features for comfort and style, combatting two of the largest barriers to compliance.

Features and Benefits:

Style

- Sleek, streamline design
- The robust temple design gives great performance and make adjustable features redundant
- Motion inspired, contoured piping in a bold, modern colour palette for an added infusion of style

Premium Protection

- Provides complete impact protection for the orbital region of the eye
- Exceeds the requirements of EN166 clause 7.2.8 Lateral Protection
- Integrated side-shield provides additional protection for surrounding tissues
- Polycarbonate lenses absorb 99.9% of UVA and UVB and meet the requirements of EN 166:2001
- 3M™ Scotchgard™ Anti-Fog/Anti-Scratch Coating resists fogging longer than traditional coatings, even after multiple washes

Comfort

- Features 3M™ Pressure Diffusion Temple Technology
- Constant temple force even with different head sizes
- Reduced frame slippage during workplace head movements
- Self adjusting temples for a secure fit

- Weighs only 19g
- Dual-injected padded temple touchpoints for added comfort over the ears
- Soft, adjustable nose pads for even greater personalisation of fit



3M™ SecureFit™ Comfort Line Safety Glasses SF402AF

Colour: grey
Lens material: polycarbonate
 Optical Class 1
 5-3.1 lens provides UV protection and glare reduction



3M™ SecureFit™ Comfort Line Safety Glasses SF403AF
Lens colour: amber



3M™ SecureFit™ Comfort Line Safety Glasses SF401AF
Lens colour: clear



3M™ SecureFit™ Comfort Line Safety Glasses SF410AS
Lens colour: indoor/outdoor



3M™ SecureFit™ Comfort Line Safety Glasses SF408AS
Lens colour: Blue Mirror



3M™ SecureFit™ Safety Glasses SF406SGAF-BLA
Lens colour: orange



3M™ SecureFit™ Safety Glasses SF407SGAF-BLU
Lens colour: grey



3M™ SecureFit™ Safety Glasses SF403SGAF-YEL
Lens colour: amber



3M™ SecureFit™ Safety Glasses SF405SGAF-BLA
Lens colour: brown



3M™ SecureFit™ Safety Glasses SF401SGAF-BLU
Lens colour: clear



3M™ SecureFit™ Safety Glasses SF401SGAF-BLU-F
Lens colour: clear



3M™ SecureFit™ Safety Glasses SF401SGAF-RED
Lens colour: clear



3M™ SecureFit™ Safety Glasses SF402SGAF-BLU
Lens colour: grey

3M™ Protective Eyewear

3M™ SecureFit™ Safety Glasses 400 Series with Reading Dioptre

The 3M™ SecureFit™ 400 Series safety glasses now feature a choice of reading dioptres (+1.5, +2.0 and +2.5) to help workers who have difficulty reading small print or who are engaged in small detail work.

Features and Benefits:

Style

- Sleek, streamline design
- The robust temple design gives great performance and make adjustable features redundant
- Motion inspired, contoured piping in bold, modern colour palette for an added infusion of style

Premium Protection

- Polycarbonate lenses absorb 99.9% of UVA & UVB. Meets the requirements of EN166:2001

Comfort

- Dual-injected, padded temple touchpoints for added comfort over the ears
- Motion-inspired, contoured piping
- Self-adjusting 3M™ Pressure Diffusion Temple Technology ensures a comfortable and a secure fit and prevents slippage
- Soft, adjustable, one-piece nose bridge for an individual comfortable fit
- Removable foam insert helps keep debris out of your eyes while providing comfort and cushioning
- 3 reader powers available +1.5, +2.0 and +2.5

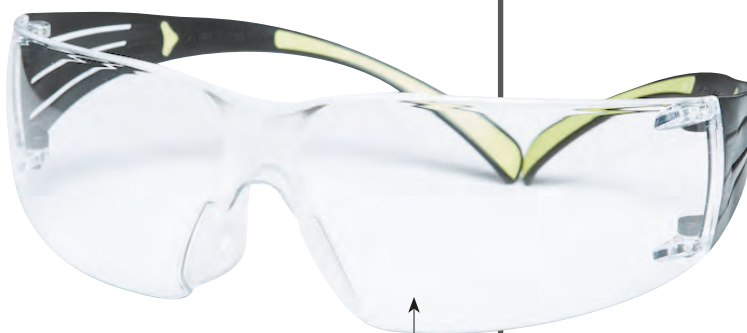

3M™ SecureFit™ 400 Series with Reading Dioptre SF415AF
Lens Colour: Clear
Dioptor strength: +1.5 AS/AF

3M™ SecureFit™ 400 Series with Reading Dioptre SF420AF
Lens Colour: Clear
Dioptor strength: +2.0 AS/AF

3M™ SecureFit™ 400 Series with Reading Dioptre SF425AF
Lens Colour: Clear
Dioptor strength: +2.5 AS/AF



3M™ SecureFit™ 400 Foam Insert SF400FI
Removable foam insert

3M™ Protective Eyewear

3M™ SecureFit™ Safety Glasses 400X Series

Modern, stylish design combined with comfortable coverage? Believe it. The 3M™ SecureFit™ 400X Series features a wide range of temple and lens colour options and a contoured brow guard to help provide additional protection from flying particles.

Features and Benefits:

Style

- Modern stylish design

Premium Protection

- Polycarbonate Lenses absorb 99.9% of UVA and UVB rays and meet the requirements of EN 166:2001
- 3M™ Scotchgard™ Anti-Fog /Anti-Scratch Coating resists fogging longer than traditional coatings, even after multiple lens washes
- 3M™ Rugged Anti-Scratch (RAS) coating is the best performing 3M anti-scratch coating. Extends durability and helps extend the life of the lens protecting against severe abrasion

Comfort

- Pressure Diffusion Temple (PDT) Technology that helps diffuse pressure over the ear for a secure, comfortable fit
- Soft nosepiece helps reduce slippage
- Brow Guard rests comfortably against forehead and helps provide additional coverage from particles



3M™ SecureFit™ 400X Series

SF401XSGAF-BLU 

Lens colour: clear



3M™ SecureFit™ 400X Series

SF401XSGAF-GRN 

Lens colour: clear



3M™ SecureFit™ 400X Series

SF402XSGAF-BLU 

Lens colour: grey



3M™ SecureFit™ 400X Series

SF407XSGAF-BLU 

Lens colour: I/O grey



3M™ SecureFit™ 400X Series

SF403XSGAF-YEL 

Lens colour: amber



3M™ SecureFit™ 400X Series

SF422XSGAF-BLK 

Lens colour: vermilion



3M™ SecureFit™ 400X Series

SF401XRAS-GRN

Lens colour: clear



3M™ SecureFit™ 400X Series

SF416XAS-BLK

Lens colour: orange mirror

3M™ Protective Eyewear

3M™ SecureFit™ Safety Glasses 600 Series

3M™ SecureFit™ 600 Series Protective Eyewear combine the best features of existing models, and add more. They are designed for maximum comfort, fit and clarity, so they stay on and wearers stay protected. A host of options means that there is the right version for any situation – lens colour choices, anti-scratch or 3M™ Scotchgard™ Anti-Fog/Anti-Scratch coating, Pressure Diffusion Temple (PDT) technology for security and comfort, foam gasket, and more.

Features and Benefits:

Style

- Semi-rimless frame with two separate lenses
- Premium style and optimal optical performance
- Multiple lens colour options including polarised lenses

Premium Protection

- Durable polycarbonate lenses absorb 99.9% of UVA and UVB rays and meet the requirements of EN 166:2001
- Optical Class 1

Available with two coating options

- 3M™ Scotchgard™ Anti-Fog/Anti-Scratch coating resists fogging longer than traditional coatings, even after multiple lens washes
-SF601SGAF (with and without Foam Insert)
Lens Material: Polycarbonate
2C-1.2 3M 1 FT KN

- 3M™ Rugged Anti-Scratch (RAS) coating is the best performing 3M anti-scratch coating. Extends durability and helps extend the life of the lens protecting against severe abrasion
-SF601RAS
Lens Material: Polycarbonate
2C-1.2 3M 1 FT K

Comfort

- Secure, comfortable fit with 3M™ Pressure Diffusion Temple (PDT) technology



3M™ SecureFit™ 600 Series SF601SGAF
Lens Colour: Clear

3M™ SecureFit™ 600 Series SF602SGAF
Lens colour: Grey
Optical Class 1
5-3.1 3M 1 FT KN

3M™ SecureFit™ 600 Series SF603SGAF
Lens colour: Amber
Optical Class 1
2C-1.2 3M 1 FT KN

3M™ SecureFit™ 600 Series SF611AS
Lens colour: Polarised
Optical Class 1
5-3.1 3M 1 FT

3M™ SecureFit™ 600 Series SF610AS
Lens colour: Indoor/Outdoor
Optical Class 1
5-1.7 3M 1 FT

3M™ SecureFit™ 600 Series SF617AS
Lens colour: Green
Shade: 1.7, anti-scratch
Optical Class 1
1.7 3M 1 F

3M™ SecureFit™ 600 Series SF601RAS
Lens colour: clear

3M™ SecureFit™ 600 Series SF630AS
Lens colour: Green
Shade: 3.0, anti-scratch
Optical Class 1
3 3M 1 F

3M™ SecureFit™ 600 Series SF601SGAF/FI
Lens colour: clear

3M™ SecureFit™ 600 Series SF650AS
Lens colour: Green
Shade: 5.0, anti-scratch
Optical Class 1
5 3M 1 F

Replacement foam gasket SF600FI

3M™ Protective Eyewear

3M™ Solus™ 1000 Safety Glasses

A fogged lens can be frustrating and dangerous. Removing eyewear to wipe away fog can expose eyes to potentially dangerous workplace impact hazards and debris.

The Scotchgard™ Anti-Fog/Anti-Scratch Coating resists fogging longer than traditional anti-fog coatings, even after washing multiple times. Try the Solus™ 1000 Series with Scotchgard™ Anti-Fog/Anti-Scratch Coating and see clearly, longer.

Features and Benefits:

Style

- Slim frame
- Colour accented soft temple components for a stylish and modern look

Premium Protection

- Strong PC lenses

3M™ Scotchgard™ Anti-Fog/Anti-Scratch Coating

- Provides scratch resistance and durability
- Provides superior anti-fog and anti-scratch properties, complying with K and N marking requirements of EN 166
- Can be disinfected with diluted bleach soaking or alcohol wipes without losing its anti-fog performance

Comfort

- Lightweight
- Soft cushioning on nose bridge
- Inner padding on temples for increased comfort and stability when worn



3M™ Solus™ S1201SGAF 
Lens colour: clear

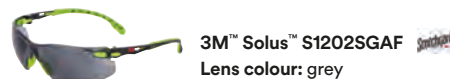

3M™ Solus™ S1202SGAF 
Lens colour: grey

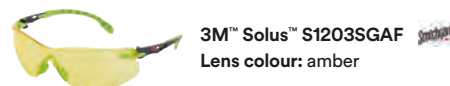

3M™ Solus™ S1203SGAF 
Lens colour: amber

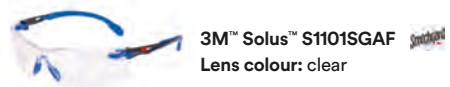

3M™ Solus™ S1101SGAF 
Lens colour: clear

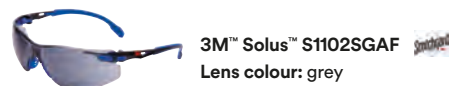

3M™ Solus™ S1102SGAF 
Lens colour: grey

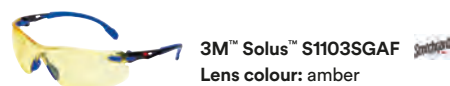

3M™ Solus™ S1103SGAF 
Lens colour: amber

Kits available with clear lens in each frame type. These include a headband and foam insert.



3M™ Solus™ Kit
S1101SGAFKT 



3M™ Solus™ Kit
S1201SGAFKT 

3M™ Protective Eyewear

3M™ Solus™ 2000 Safety Glasses

The 3M™ Solus™ 2000 Series features adjustable ratchet temples that allow the wearer to customise.

Choose from several lens coating options, including the 3M™ Scotchgard™ Anti-Fog/Anti-Scratch coating, multiple lens colours and features like a removable foam gasket to create a protective eyewear solution for you.

Features and Benefits:

Style

- Versatile design allows use with wide variety of prescription eyewear

Premium Protection

- Polycarbonate Lenses absorb 99.9% of UVA and UVB rays and meet the requirements of EN 166:2001
- 3M™ Scotchgard™ Anti-Fog/Anti-Scratch coating resists fogging longer than traditional coatings, even after multiple washes
- ASP: Anti-scratch coating meeting "K" requirements of EN 166 (S2001ASP-BLU)

Comfort

- Adjustable Ratchet temples allow user to adjust lens for facial features and eyeglass position



3M™ Solus™ 2000 Series

S2001SGAF-RED 
Lens Colour: Clear



3M™ Solus™ 2000 Series
S2002SGAF-RED 
Lens colour: grey



3M™ Solus™ 2000 Series
S2001SGAF-BGR 
Lens colour: clear



3M™ Solus™ 2000 Series
S2002SGAF-BGR 
Lens colour: grey



3M™ Solus™ 2000 Series
S2003SGAF-BGR 
Lens colour: amber



3M™ Solus™ 2000 Series
S2005SGAF-BGR 
Lens colour: brown



3M™ Solus™ 2000 Series
S2007SGAF-BGR 
Lens colour: grey



3M™ Solus™ 2000 Series
S2001ASP-BLU
Lens colour: clear



3M™ Solus™ 2000 Series
S2001AF-BLU
Lens colour: clear



3M™ Solus™ 2000 Series
S2024AS-RED
Lens colour: red mirror



3M™ Solus™ 2000 Series
S2001SGAF-BGR-F 
Lenc colour: clear

Readers and IR Shade models due end 2019

3x reader powers +1.5, +2, +2.5

3x IR pairs IR 1.7, IR 3 and IR 5

3M™ Protective Eyewear

3M™ Solus™ CCS Safety Glasses

With integrated Cord Control System (CCS) temples, the 3M™ Solus™ CCS Series eyewear helps you keep everything under control. The versatile design helps keep eyewear and earplugs attached, untangled and ready to use, so your team has the convenient, comfortable protection they need to focus on the jobs at hand.

Features and Benefits:

Style

- Stylish and modern design

Premium Protection

- Excellent peripheral vision and lateral side protection
- Good impact resistance with Anti-Scratch coating for improved durability
- Anti-Fog coating which reduces fogging and ensures clearer vision
- Designed to keep eyewear and earplugs attached, untangled and ready for use
- 3M™ Scotchgard™ Anti-Fog /Anti-Scratch Coating resists fogging longer than traditional coatings, even after multiple lens washes

Comfort

- Lightweight and comfortable

Compatible with:

- Slim nose bridge and flat temples for improved compatibility with other PPE
- Compatible with a variety of 3M™ E-A-R™ corded earplugs
- Earplug cord can be worn around the neck to carry eyewear when neither product is in use



3M™ Solus™ CCS Series

SCCS01SGAF-GRN-F 

Lens colour: clear



3M™ Solus™ CCS Series

SCCS01SGAF-GRN 

Lens colour: clear



3M™ Solus™ CCS Series

SCCS02SGAF-GRN 

Lens colour: grey



3M™ Solus™ CCS Series

SCCS07SGAF-GRN 

Lens colour: I/O grey



3M™ CCS Safety Glasses

Lens colour: clear



3M™ CCS Foam Insert

3M™ Protective Eyewear

3M™ Classic Line Safety Glasses 2820 Series

Very lightweight, the 3M 2820 Safety Glasses are a sleek, modern design offering excellent coverage and field of vision.

Features and Benefits:

Style

- Stylish and modern design, eye protection is more likely to be worn if it looks good

Premium Protection

- Optical Class 1 for high optical clarity and extended wear time
- Polycarbonate lens offers good impact resistance
- Wrap-around design for increased lateral protection

Comfort

- Very lightweight 21g
- Inclinable lens for easy adjustment and maximum comfort
- Soft, flexible temples for improved comfort

Compatible

- Fits well with 3M™ Respirators

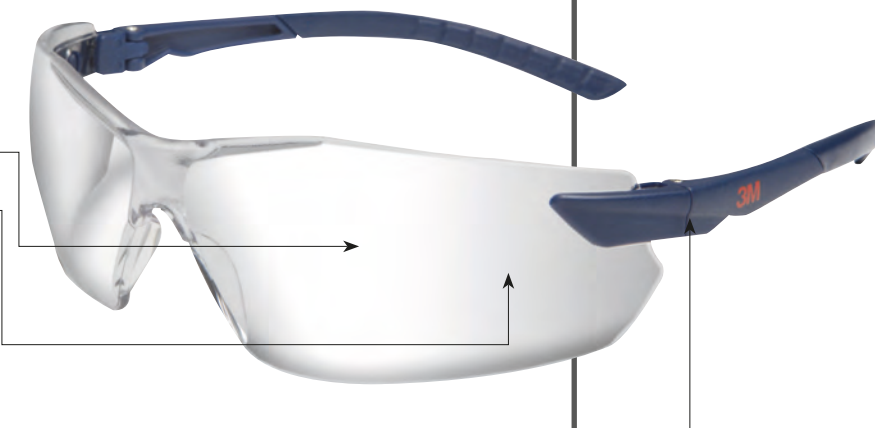

3M™ Classic Line Safety Glasses 2820
Lens Colour: clear

3M™ Classic Line Safety Glasses 2821
Lens colour: grey

3M™ Classic Line Safety Glasses 2822
Lens colour: amber

3M™ Protective Eyewear

3M™ Virtua™ AP Classic Line Safety Glasses

The 3M™ Virtua™ AP features a graceful, unisex styling and lightweight comfort to help promote compliance.

Features and Benefits:

Style

- Unisex styling

Premium Protection

- Clear and grey anti-scratch lenses
- Integral side-shields and brow guard
- Polycarbonate lens absorbs 99,9% UV

Comfort

- Comfortable, impact-resistant, lightweight frame - weighs less than 26g



3M™ Virtua™ AP Classic Line Safety Glasses
Lens colour: clear



3M™ Virtua™ AP Classic Line Safety Glasses
Lens colour: grey

3M™ Protective Eyewear

3M™ Tora™ Classic Line Safety Glasses

The 3M™ Tora™ Classic Line Safety Glasses' cool image makes this line of protective eyewear very popular amongst younger members of staff.

Features and Benefits:

Style

- Stylish and modern design, eye protection is more likely to be worn if it looks good

Premium Protection

- Excellent peripheral vision and lateral side protection
- Good impact resistance with Anti-Scratch coating for improved durability
- Anti-Fog coating which reduces fogging and ensures clearer vision
- Designed to keep eyewear and earplugs attached, untangled and ready to use
- Can help reduce the expense of replacing lost earplugs and eyewear

Comfort

- Lightweight and comfortable

Compatible

- Slim nose bridge and flat temples for improved compatibility with other PPE



3M™ Tora™ Classic Line Safety Glasses
Lens colour: clear



3M™ Tora™ Classic Line Safety Glasses
Lens colour: amber



3M™ Tora™ Classic Line Safety Glasses
Lens colour: bronze

3M™ Protective Eyewear

3M™ Comfort Line Safety Glasses 2840 Series

Protection, comfort and adjustability. With a unique style, the 2840 Safety Glasses have been designed with user comfort and convenience in mind. The temples are fully inclinable and adjustable in length for optimal fit. The soft inner padding offers increased comfort.

The 3M™ Safety Glasses 2840 also feature an integrated browguard for increased protection incorporating a strong polycarbonate lens with anti-scratch and anti-fog coating (except 3M™ Safety Glasses 2844), they are available in 6 lens options.

Features and Benefits:

Style

- Stylish and modern design, eye protection is more likely to be worn if it looks good

Premium Protection

- Optical Class 1 to allow prolonged, comfortable wear
- Integrated browguard for increased protection
- Strong polycarbonate lens with anti-scratch and anti-fog coating
- Polycarbonate lens for good impact protection

Comfort

- Adjustable temple length (3 positions) for comfort and optimal fit
- Soft inner padding on temple for increased comfort and stability when worn
- Inclinable lens enabling individual adjustment and optimal personal fit
- Lightweight (26g)



3M™ Comfort Line Safety Glasses 2840
Lens colour: clear

3M™ Comfort Line Safety Glasses 2841
Lens colour: grey

3M™ Comfort Line Safety Glasses 2842
Lens colour: amber

3M™ Comfort Line Safety Glasses 2844
Lens colour: Indoor Outdoor Mirror

3M™ Comfort Line Safety Glasses 2846
Lens colour: red-orange

3M™ Comfort Line Safety Glasses 2845
Lens colour: IR shade 5

3M™ Protective Eyewear

3M™ SecureFit™ 3700 Overspectacles

Get over-the-glass protection with all day wearability with the 3M™ SecureFit™ 3700 Series. Featuring Pressure Diffusion Temple (PDT) Technology and adjustable ratchet temples, the SecureFit 3700 Series offers over-the-glass protection with a personalised fit.

Features and Benefits:

Style

- Versatile design allows use with wide variety of prescription eyewear

Premium Protection

- Polycarbonate Lenses absorb 99.9% of UVA and UVB rays and meet the requirements of EN 166:2001
- 3M™ Scotchgard™ Anti-Fog/ Anti-Scratch Coating resists fogging longer than traditional coatings, even after multiple washes
- ASP: Anti-scratch coating meeting K requirements of EN 166 (S2001ASP-BLU)

Comfort

- Pressure Diffusion Temple (PDT) Technology that helps diffuse pressure over the ear for a secure, comfortable fit
- Adjustable Ratchet temples allow user to adjust lens for facial features and eyeglass position
- Brow Guard rests comfortably against forehead and helps provide additional coverage from particles



3M™ SecureFit™ 3700 OTG
SF3701SGAF-BLU 
Lens colour: clear



3M™ SecureFit™ 3700 OTG
SF3701ASP-BLU
Lens colour: clear



3M™ SecureFit™ 3700 OTG
SF3702SGAF-BLU 
Lens colour: grey



3M™ SecureFit™ 3700 OTG
SF3707SGAF-BLU 
Lens colour: grey



3M™ SecureFit™ 3700 OTG
SF3701SGAF-ORG 
Lens colour: clear



3M™ SecureFit™ 3700 OTG
SF3701SGAF-GRN 
Lens colour: clear



3M™ SecureFit™ 3700 OTG
SF3703SGAF-GRN 
Lens colour: amber

Models with Brow Guard:



3M™ SecureFit™ 3700 OTG
SF3701XSGAF-BLU 
Lens colour: clear



3M™ SecureFit™ 3700 OTG
SF3702XSGAF-BLU 
Lens colour: grey



3M™ SecureFit™ 3700 OTG
SF3707XSGAF-BLU 
Lens colour: I/O grey

3M™ Protective Eyewear

3M™ Overspectacles 2800 Series

The 3M™ 2800 Overspectacles are designed to fit over most users' prescription eyewear with minimal interference. They offer an excellent coverage and field of vision, combined with a high level of protection against impacts.

Features and Benefits:

Style

- Versatile design allows use with wide variety of prescription eyewear

Premium Protection

- Optical Class 1 for high optical clarity to allow prolonged, comfortable wear
- Polycarbonate lens offers good impact resistance with Anti-Scratch coating for improved durability

Comfort

- Adjustable length temples (4 positions) for optimal comfort and fit
- Inclinable lens for easy adjustment and maximum comfort
- Soft low profile temples for comfort and minimum interaction with prescription eyewear



3M™ Over Safety Glasses 2805
Lens colour: IR Shade 5



3M™ Over Safety Glasses 2800
Lens colour: clear



3M™ Over Safety Glasses 2801
Lens colour: grey



3M™ Over Safety Glasses 2802
Lens colour: amber

3M™ Protective Eyewear

3M™ GoggleGear™ 6000 Safety Goggles

With models featuring 3M™ Scotchgard™ Anti-Fog Coating, the 3M™ GoggleGear™ 6000 Series is a large profile goggle design that provides better fog and abrasion resistance when compared to traditional anti-fog coatings. All models are designed with indirect venting to help reduce fogging. Both adjustable nylon fibre cloth straps and neoprene straps are available to suit your comfort and style.

Features and Benefits:

Style

- Large profile can fit over numerous prescription eyeglasses
- Available in a variety of colourful styles

Premium Protection

- Indirect Venting helps reduce fogging
- Polycarbonate Lenses absorb 99.9% of UVA and UVB rays and meet the requirements of EN 166:2001
- 3M™ Scotchgard™ Anti-Fog/Anti-Scratch Coating resists fogging longer than traditional coatings, even after multiple washes

Comfort

- Soft Goggle Shroud helps seal against the face
- Comfortable strap – choose from models with nylon or neoprene strap
- Neoprene Strap comes standard with GG6001SGAF-BLU and can be sterilised using an autoclave



3M™ Goggle Gear Protective Eyewear 6000
GG6001SGAF-GRN 
Lens Colour: Clear



3M™ Goggle Gear
Protective Eyewear 6000
GG6001SGAF-BLK 
Lens colour: clear



3M™ Goggle Gear
Protective Eyewear 6000
GG6002SGAF-BLK 
Lens colour: grey



3M™ Goggle Gear
Protective Eyewear 6000
GG6001SGAF-RED 
Lens colour: clear



3M™ Goggle Gear
Protective Eyewear 6000
GG6001NSGAF-BLU 
Lens colour: clear

3M™ Protective Eyewear

3M™ GoggleGear™ 500 Safety Goggles

3M™ GoggleGear 501 has a low profile design, an adjustable headband and optional prescription insert. The goggle is available with a Scotchgard™ Anti-Fog/Anti-Scratch coating which resists fogging longer than traditional anti-fog coatings.

Features and Benefits:

Style

- Modern, slim-line and lightweight design for an excellent fit

Premium Protection

- Optical class 1 lens suitable for prolonged use
- Coating retains its effectiveness even after multiple washings
- Offers excellent protection against UV radiation
- Separate prescription lens can be fitted into the GoggleGear 500

3M™ Scotchgard™ Anti-Fog/Anti-Scratch Coating

- Provides scratch resistance and durability
- Provides superior anti-fog and anti-scratch properties, complying with K and N marking requirements of EN 166
- Can be disinfected with diluted bleach soaking or alcohol wipes without losing its anti-fog performance

Comfort

- Easy-to-adjust elastic Nylon headband for stable and comfortable wear
- Pivoting ratchet for convenient personal adjustment
- Neoprene Strap comes as standard with GG501NSGAF and can be sterilised using an autoclave



3M™ Goggle Gear 500 Series
GG501SGAF 
Lens colour: clear



Prescription insert



3M™ Goggle Gear 500 Series
GG502SGAF 
Lens colour: grey



3M™ Goggle Gear 500 Series
GG550SGAF 
Lens colour: IR5 grey



3M™ Goggle Gear 500 Series
GG501NSGAF-BLU 
Lens colour: clear

3M™ Protective Eyewear

3M™ Maxim™ Hybrid Goggles

The 3M™ Maxim™ Hybrid goggle is a very lightweight, low profile form of eyewear protection that provides the same protection as traditionally styled goggles. It provides high comfort and unsurpassed protection against liquid droplets

and mechanical hazards. The slim design offers improved comfort and wearer acceptance.

Features and Benefits:

Style

- Modern and slim design

Premium Protection

- Patented aspherical lens for excellent field of view and superior eye coverage
- High performance ventilation system

Compatible

- Special design for improved compatibility with other PPE

3M™ Maxim™ Hybrid Goggles
Lens Colour: clear



3M™ Protective Eyewear

3M™ Comfort Line Safety Goggles 2890 Series

The 3M™ Comfort Line Safety Goggles 2890 Series feature a modern, slim design and are available with four different options using either an acetate or polycarbonate lens with either sealed or indirect ventilation. They are suitable for a number of different applications where a versatile, comfortable goggle is required.

Features and Benefits:

Style

- Modern, slim-line and lightweight design for an excellent fit

Premium Protection

- Sealed design (3M™ 2890S & 3M™ 2890SA) helps provide protection against liquids, dust, gases and vapours
- Indirect ventilation design (3M™ 2890 & 3M™ 2890A) for improved air circulation, comfort and reduced fogging in hot/humid conditions
- Acetate lens option (2890A & 2890SA) for excellent chemical resistance and protection against high speed particles at low energy EN166 1 FT
- Polycarbonate lens option (2890 & 2890S) protects against high speed particles at medium energy EN166 1 BT and molten metal
- Anti-Scratch features an extremely scratch resistant coating ensuring improved durability (2890 & 2890S only)
- Anti-Fog coating reduces fogging and ensures clearer vision
- UV Protection gives reliable protection against specified levels of hazardous UV radiation
- The 2895S lenses are assessed against EN169:2002 for transmittance requirement for welding filters. This product protects against high speed impact at medium energy at room temperature only
- 3M™ Scotchgard™ Anti-Fog/Anti-Scratch Coating resists fogging longer than traditional coatings, even after multiple washes

Comfort

- Easy-to-adjust strap for stable and comfortable wear
- Pivoting ratchet for convenient personal adjustment
- Replacement lens options for 2890/2890S and 2890A/2890SA

Compatible

- Fits well with 3M™ Respirators

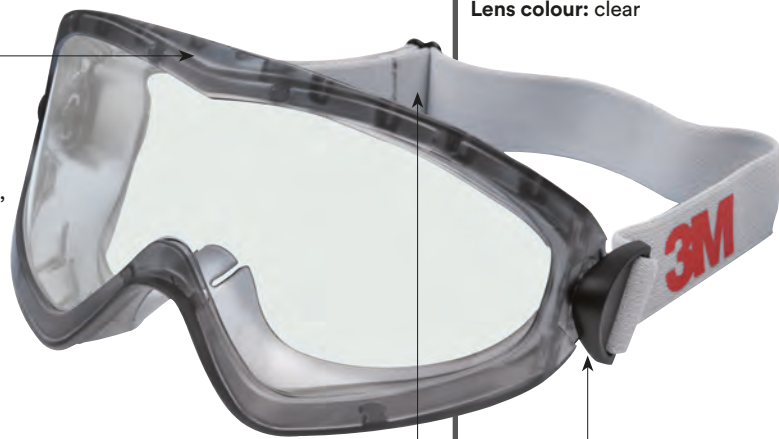

3M™ Goggles 2890
Lens colour: clear



3M™ Goggles 2890A
Lens colour: clear



3M™ Goggles 2890S
Lens colour: clear



3M™ Goggles 2890SA
Lens colour: clear



3M™ Goggles 2895S
Lens colour: welding shade 5.0



3M™ Goggles 2891-SGAF 
Lens colour: clear



3M™ Goggles 2891S-SGAF 
Lens colour: clear

3M™ Protective Eyewear

3M™ Fahrenheit™ Comfort Goggles

The Fahrenheit comfort goggle features a modern, slim design and is available with an acetate or polycarbonate lens with either sealed or indirect ventilation. It is suitable for a number of different applications where a versatile, comfortable goggles is required.

Features and Benefits:

Style

- Modern, slim-line and lightweight design for an excellent fit

Premium Protection

- Aerodynamic shape with cylindrical lens for excellent field of vision
- Indirect ventilation system to prevent fog, liquids and dust (on selected models)

Comfort

- Wide nylon elastic strap (25mm) which is easily adjustable thanks to a buckle system and to a pivoting strap attachment mechanism
- A Neoprene headband, easy to clean, specially for the food industry (on selected models)
- T-N-Wear Solution – available with an additional polyester film that can be easily removed and replaced

Compatible

- Special helmet version is compatible with PELTOR™ Helmet G3000



3M™ Fahrenheit™ Comfort Goggle
Lens Colour: clear



3M™ Fahrenheit™
for PELTOR™ Helmet
Lens colour: clear



3M™ Fahrenheit™
T-N-Wear
Lens colour: clear

3M™ Protective Eyewear

Product information

3M™ Eyewear	Impact Protection	Coating	Lens Filter and Shading	Visual Light Lens Transmittance (approx.)	EN1 66 Lens Marking	Mechanical work	Outside Work	Driver	Metallurgy	Surface Inspection
Overspectacles										
3M™ Overspectacles 2800 Series										
3M™ 2800	FT	AS	Clear 2C-1.2	88%	2C-1.2 3M 1 FT	Y			Y	
3M™ 2801	FT	AS	Grey 5-3.1	14%	5-3.1 3M 1 FT	Y	Y	Y		
3M™ 2802	FT	AS	Amber 2-1.2	83%	2-1.2 3M 1 FT	Y				Y
3M™ 2805	FT	AS	IR 5	2%	4-5 3M 1 FT	Y			Y	
3M™ SecureFit™ 3700 Overspectacles										
3M™ SF3701ASP-BLU	FT	AS+	Clear 2C-1.2	89%	2C-1.2 3M 1 FT K	Y			Y	
3M™ SF3701SGAF-BLU / SF3701SGAF-GRN / SF3701SGAF-ORG / SF3701XSGAF-GRN	FT	SGAF	Clear 2C-1.2	89%	2C-1.2 3M 1 FT KN	Y			Y	
3M™ SF3702SGAF-BLU / SF3702XSGAF-BLU	FT	SGAF	Grey 5-3.1	11%	5-3.1 3M 1 FT KN	Y	Y	Y		
3M™ SF3703SGAF-BLU	FT	SGAF	Amber 2C-1.2	87%	2C-1.2 3M 1 FT KN	Y				Y
3M™ SF3707SGAF-BLU / SF3707XSGAF-BLU	FT	SGAF	Indoor / Outdoor grey 5-1.7	51%	5-1.7 3M 1 FT KN		Y	Y		
Safety Glasses										
3M™ SecureFit™ 200 Safety Glasses										
3M™ SF201AS	FT	AS	Clear 2C-1.2	91%	2C-1.2 3M 1 FT	Y			Y	
3M™ SF201AF	FT	AS/AF	Clear 2C-1.2	91%	2C-1.2 3M 1 FT	Y			Y	
3M™ SF203AF	FT	AS/AF	Amber 2C-1.2	90%	2C-1.2 3M 1 FT	Y				Y
3M™ SF202AF	FT	AS/AF	Grey 5-3.1	13%	5-3.1 3M 1 FT	Y	Y	Y		
3M™ SF201SGAF	FT	SGAF	Clear 2C-1.2	89%	2C-1.2 3M 1 FT KN	Y			Y	
3M™ SecureFit™ 400 Safety Glasses										
3M™ SF401AF	FT	AS/AF	Clear 2C-1.2	91%	2C-1.2 3M 1 FT	Y			Y	
3M™ SF403AF	FT	AS/AF	Amber 2C-1.2	90%	2C-1.2 3M 1 FT	Y				Y
3M™ SF402AF	FT	AS/AF	Grey 5-3.1	13%	5-3.1 3M 1 FT	Y	Y	Y		
3M™ SF410AS	FT	AS/AF	Indoor/ Outdoor 5-1.7	54%	5-1.7 3M 1 FT		Y	Y		
3M™ SF408AS	FT	AS/AF	Blue Mirror 5-3.1	14%	5-3.1 3M 1 FT	Y		Y		
3M™ SF401SGAF / SF401XSGAF	FT	SGAF	Clear 2C-1.2	89%	2C-1.2 3M 1 FT KN	Y			Y	
3M™ SF402SGAF / SF402XSGAF	FT	SGAF	Grey 5-3.1	12%	5-3.1 3M 1 FT KN	Y	Y	Y		
3M™ SF403SGAF / SF403XSGAF	FT	SGAF	Amber 2C-1.2	87%	2C-1.2 3M 1 FT KN	Y				Y
3M™ SF405SGAF	FT	SGAF	Brown 5-2.5	22%	5-2.5 3M 1 FT KN	Y	Y	Y		
3M™ SF403SGAF	FT	SGAF	Orange 2-1.7	45%	2-1.7 3M 1 FT KN	Y				Y
3M™ SF407SGAF	FT	SGAF	Indoor / Outdoor 5-1.7	48%	5-1.7 3M 1 FT KN		Y	Y		
3M™ SF415AF (+1.5 diopter)	FT	AS/AF	Clear 2C-1.2	91%	2C-1.2 3M 1 FT KN	Y			Y	
3M™ SF420AF (+2.0 diopter)	FT	AS/AF	Clear 2C-1.2	91%	2C-1.2 3M 1 FT KN	Y			Y	
3M™ SF425AF (+2.5 diopter)	FT	AS/AF	Clear 2C-1.2	91%	2C-1.2 3M 1 FT KN	Y			Y	
3M™ SF422XSGAF	FT	SGAF	Vermillion 2-2	37%	2-2 3M 1 FT KN		Y			
3M™ SF416XAS	FT	AS/AF	Orange Mirror 5-3.1	12%	2C-1.2 3M 1 FT	Y	Y			
3M™ SF401XNAS	FT	RAS	Clear 2C-1.2	89%	2C-1.2 3M 1 FT K	Y	Y	Y		

*Visual Lens Light Transmittance percentages quoted are typical values as results may vary

MECHANICAL WORK
Grinding, drilling, stone cutting, maintenance
RISKS: Impact, dust (Goggles only)

OUTSIDE WORK
Gardening, road works, building site work, shooting
RISKS: Impact, glare, UV

DRIVER
Fork lift truck, heavy plant, HGV, PSV
RISKS: Glare, UV

METALLURGY
Furnace works, casting control, mould maintenance
RISKS: Impact, dust, infrared, molten metal, glare (only goggles)

SURFACE INSPECTION
Quality control, wood lamp, curing
RISKS: Ultraviolet, Blue light

3M™ Protective Eyewear

3M™ Eyewear	Impact Protection	Coating	Lens Filter and Shading	Visual Light Lens Transmittance (approx.)	EN1 66 Lens Marking	Mechanical work	Outside Work	Driver	Metallurgy	Surface Inspection
3M™ SecureFit™ 600 Safety Glasses										
3M™ SF601SGAF / 3M™ SF601SGAF/FI	FT	SGAF	Clear 2C-1.2	91%	2C-1.2 3M 1 FT KN	Y			Y	
3M™ SF602SGAF	FT	SGAF	Grey 5-3.1	13%	5-3.1 3M 1 FT KN	Y	Y	Y		
3M™ SF603SGAF	FT	SGAF	Amber 2C-1.2	86%	2C-1.2 3M 1 FT KN	Y				Y
3M™ SF610AS	FT	AS	Indoor / outdoor mirror 5-1.7	48%	5-1.7 3M 1 FT		Y	Y		
3M™ SF611AS	FT	AS	Grey polarised 5-3.1	14%	5-3.1 3M 1 FT	Y	Y			
3M™ SF617AS	F	AS	Welding shade 1.7	52%	1.7 3M 1 F	Y			Y	
3M™ SF630AS	F	AS	Welding shade 1.7	11%	3 3M 1 F	Y			Y	
3M™ SF650AS	F	AS	Welding shade 5	2%	5 3M 1 F	Y			Y	
3M™ SF601RAS	FT	RAS	Clear 2C-1.2	91%	2C-1.2 3M 1 FT K	Y			Y	
3M™ 2820 Series Safety Glasses										
3M™ 2820	FT	AS/AF	Clear 2C-1.2	90%	2C-1.2 3M 1 FT	Y			Y	
3M™ 2821	FT	AS/AF	Grey 5-2.5	20%	5-2.5 3M 1 FT	Y	Y	Y		
3M™ 2822	FT	AS/AF	Amber 2-1.2	88%	2-1.2 1 3M FT	Y				Y
3M™ Virtua™ AP Safety Glasses										
3M™ Virtua™ AP	FT	AS	Clear 2C-1.2	90%	2C-1.2 3M 1 FT	Y			Y	
3M™ Virtua™ AP	FT	AS	Grey 5-2.5	21%	5-2.5 3M 1 FT	Y	Y	Y		
3M™ Tora Series Safety Glasses										
3M™ Tora™ (Clear)	FT	AS/AF	Clear 2C-1.2	90%	2C-1.2 3M 1 FT	Y			Y	
3M™ Tora™ (Amber)	FT	AS/AF	Amber 2C-1.2	86%	2C-1.2 3M 1 FT	Y				Y
3M™ Tora™ (Bronze)	FT	AS/AF	Bronze 5-2.5	27%	5-2.5 3M 1 FT	Y	Y	Y		
3M™ 2840 Series Safety Glasses										
3M™ 2840	FT	AS/AF	Clear 2C-1.2	88%	2C-1.2 3M 1 FT	Y			Y	
3M™ 2841	FT	AS/AF	Grey 5-2.5	23%	5-2.5 3M 1 FT		Y	Y		
3M™ 2842	FT	AS/AF	Amber 2-1.2	83%	2-1.2 3M 1 FT	Y				Y
3M™ 2844	FT	Mirror	Indoor / outdoor Mirror 5-1.7	49%	5-1.7 3M 1 FT		Y	Y		
3M™ 2845	FT	AS/AF	Welding shade 5	2%	5 3M 1 FT				Y	
3M™ 2846	FT	AS/AF	Red / orange 2-1.7	47%	2-1.7 3M 1 FT	Y				Y
3M™ Solus 1000 Series Safety Glasses										
3M™ S1101SGAF / 3M™ S1201SGAF / 3M™ S1101SGAFKT / 3M™ S1201SGAFKT	FT	SGAF	Clear 2C-1.2	91%	2C-1.2 3M 1 FT KN	Y			Y	
3M™ S1102SGAF / S1202SGAF	FT	SGAF	Grey 5-3.1	14%	5-3.1 3M 1 FT KN	Y	Y	Y		
3M™ S1103SGAF / S1203SGAF	FT	SGAF	Amber 2C-1.2	89%	2C-1.2 3M 1 FT KN	Y				Y

*Visual Lens Light Transmittance percentages quoted are typical values as results may vary

MECHANICAL WORK
Grinding, drilling, stone cutting, maintenance
RISKS: Impact, dust (Goggles only)

OUTSIDE WORK
Gardening, road works, building site work, shooting
RISKS: Impact, glare, UV

DRIVER
Fork lift truck, heavy plant, HGV, PSV
RISKS: Glare, UV

METALLURGY
Furnace works, casting control, mould maintenance
RISKS: Impact, dust, infrared, molten metal, glare (only goggles)

SURFACE INSPECTION
Quality control, wood lamp, curing
RISKS: Ultraviolet, Blue light

3M™ Protective Eyewear

Product information

3M™ Eyewear	Impact Protection	Coating	Lens Filter and Shading	Visual Light Lens Transmittance (approx.)	EN1 66 Lens Marking	Mechanical work	Outside Work	Driver	Metallurgy	Surface Inspection
3M™ Solus 2000 Series Safety Glasses										
3M™ S2001SGAF-RED / 3M™ S2001SGAF-BGR / 3M™ S2001SGAF-BGR-F	FT	SGAF	Clear 2C-1.2	90%	2C-1.2 3M 1 FT KN	Y			Y	
3M™ S2002SGAF-RED / S2002SGAF-BGR	FT	SGAF	Grey 5-3.1	11%	5-3.1 3M 1 FT KN	Y	Y	Y		
3M™ S2003SGAF-BGR	FT	SGAF	Amber 2C-1.2	87%	2C-1.2 3M 1 FT KN	Y		Y		Y
3M™ S2005SGAF-BGR	FT	SGAF	Brown 5-2.5	23%	5-2.5 3M 1 FT KN	Y	Y	Y		
3M™ S2007SGAF-BGR	FT	SGAF	Indoor / outdoor grey 5-1.7	51%	5-1.7 3M 1 FT KN		Y	Y		
3M™ S2024AS-RED	FT	AS	Red mirror 5-3.1	14%	5-3.1 3M 1 FT	Y	Y	Y		
3M™ S2001ASP-BLU	FT	AS+	Clear 2C-1.2	90%	2C-1.2 3M 1 FT K	Y	Y		Y	
3M™ S2001AF-BLU	FT	AS/AF	Clear 2C-1.2	90%	2C-1.2 3M 1 FT	Y			Y	
3M™ Solus CCS Series Safety Glasses										
3M™ CCS	FT	AS/AF	Clear 2C-1.2	90%	2C-1.2 3M 1 FT	Y			Y	
3M™ SCCS01SGAF-GRN-EU	FT	SGAF	Clear 2C-1.2	88%	2C-1.2 3M 1 FT KN	Y			Y	
3M™ SCCS02SGAF-GRN-EU	FT	SGAF	Grey 5-3.1	11%	5-3.1 3M 1 FT KN	Y	Y	Y		
3M™ SCCS07SGAF-GRN-EU	FT	SGAF	Indoor / outdoor grey 5-1.7	51%	5-1.7 3M 1 FT KN		Y	Y		

3M™ Eyewear	Impact Protection	Coating	Lens Filter and Shading	Visual Light Lens Transmittance (approx.)	EN1 66 Lens Marking	Mechanical work	Outside Work	Chemical Application	Metallurgy	Surface Inspection
Goggles										
3M™ 2890 Safety Goggles										
3M™ 2890	BT	AS/AF	Clear 2C-1.2	89%	2C-1.2 3M 1 BT KN	Y		Y	Y	
3M™ 2890A	FT	AF	Clear 2C-1.2	84%	2C-1.2 3M 1 FT N			Y		
3M™ 2890S	BT	AS/AF	Clear 2C-1.2	89%	2C-1.2 3M 1 BT	Y		Y	Y	
3M™ 2890SA	FT	AF	Clear 2C-1.2	84%	2C-1.2 3M 1 FT N			Y		
3M™ 2895S	B	AS/AF	"Welding shade 5"	2%	5 3M 1 B KN	Y		Y	Y	
3M™ 2891-SGAF	BT	SGAF	Clear 2C-1.2	88%	2C-1.2 3M 1 BT 9 KN	Y		Y	Y	
3M™ 2891S-SGAF	BT	SGAF	Clear 2C-1.2	88%	2C-1.2 3M 1 BT 9 KN	Y	Y	Y	Y	
3M™ GG500 Safety Goggles										
3M™ GG501SGAF	BT	SGAF	Clear 2C-1.2	89%	2C-1.2 3M 1 BT KN	Y		Y	Y	
3M™ GG5001NSGAF	BT	SGAF	Clear 2C-1.2	89%	2C-1.2 3M 2 BT KN	Y		Y	Y	
3M™ GG502SGAF	BT	SGAF	Grey 5-3.1	13%	5-3.1 3M 1 BT KN	Y	Y	Y		
3M™ GG550SGAF	B	SGAF	"Welding shade 5"	2%	5 3M 1 B KN			Y		
3M™ GG60000 Safety Goggles										
3M™ GG6001SGAF-BLK / GG6001SGAF-GRN / GG6001SGAF-RED / GG6001NSGAF-BLU	BT	SGAF	Clear 2C-1.2	89%	2C-1.2 3M 1 BT KN	Y		Y	Y	
3M™ GG6002SGAF-BLK	BT	SGAF	Grey 5-3.1	11%	5-3.1 3M 1 BT KN	Y	Y	Y		
3M™ Maxim™ Hybrid Goggles										
3M™ Maxim™ Hybrid (Clear)	FT	AS/AF	NA	88%	3M 1 FT	Y			Y	

Key:

B = Impact protection against high speed particles at low energy (45m/s)
 F = Impact protection against medium speed particles at low energy (120m/s)
 T = Tested for impact at extreme temperature conditions (-5°C and +55°C)
 AS = Anti-Scratch
 AF = Anti-Fog

SGAF = Scotchgard™ Anti-Fog
 AS+ = Anti-Scratch Plus
 RAS = Rugged Anti-Scratch
 K = Resistance top surface damage by fine particles
 N = Resistance to fogging

*Visual Lens Light Transmittance percentages quoted are typical values as results may vary

MECHANICAL WORK
 Grinding, drilling, stone cutting, maintenance
 RISKS: Impact, dust (Goggles only)

OUTSIDE WORK
 Gardening, road works, building site work, shooting
 RISKS: Impact, glare, UV

DRIVER
 Fork lift truck, heavy plant, HGV, PSV
 RISKS: Glare, UV

CHEMICAL APPLICATION
 Laboratory, painting, general surgery
 RISKS: Liquid splash (acid, alkalis), infected blood

METALLURGY
 Furnace works, casting control, mould maintenance
 RISKS: Impact, dust, infrared, molten metal, glare (only goggles)

SURFACE INSPECTION
 Quality control, wood lamp, curing
 RISKS: Ultraviolet, Blue light



3M™ Scott™ Fire & Safety Solutions

3M and Scott both have long histories of offering high quality protective equipment that enables end users to do their job more efficiently, more comfortably and most importantly — more safely. Our goal is forever innovating to help keep you safe. With that in mind 3M offers the widest and most complete portfolio of respiratory protection to a wide range of industrial rescue applications and complete protection for the world's firefighters.

3M™ Scott™ V-series Thermal Imagers

3M™ Scott™ V320 Thermal Imager

The V320 Thermal Imager, featuring a 320×240 sensor and equipped with extended battery life, provides firefighters with enhanced situational awareness that enables firefighters to make better decisions in extreme conditions.

3M™ Scott™ V206 Thermal Imager

The V206 Thermal Imager, featuring a 206×156 sensor and equipped with extended battery life, provides firefighters with enhanced situational awareness that enables firefighters to make better decisions in extreme conditions. This lower cost camera is also suitable for industrial applications.

Features and Benefits:

V320: 320×240 high resolution sensor
V206: 206×156 high resolutions sensor
Provides clear images enabling firefighters to navigate through limited-visibility conditions.

Extended battery life
Up to eight-hour runtime with a removable rechargeable battery.

Single button
Single button ON/OFF provides easy deployment. No menus required.

90mm (3.5") high-contrast display
Ensures the image on the display can be seen in multiple light conditions.

Fast startup time
Ready for use within five seconds of activating the power button– without the use of a standby mode.

Lightweight, durable design
Designed to withstand extreme conditions.

Ergonomics
Ergonomically designed and balanced for comfort with a gloved hand.



Accessories

Desktop charger



Batteries



Retractable lanyard



Escape

3M™ Scott™ Flite COV Supplied Air Respirator

The Flite COV Supplied Air Respirator provides emergency respiratory protection and escape capability allowing the user to enter hazardous atmospheres including those identified as Immediately Dangerous to Life or Health (IDLH).



3M™ Scott™ ELSA Emergency Life Support Apparatus

ELSA (Emergency Life Support Apparatus) is designed for rapid escape from hazardous industrial and marine environments.



Facemasks

3M™ Scott™ AV-3000 HT Facemask

The AV-3000 HT is a high performance facemask, manufactured using materials which have been engineered to provide enhanced thermal durability and improved wearer safety in the most extreme conditions.



3M™ Scott™ Vision 3 Positive Pressure Facemask

The Vision 3 is specifically designed for use with the 3M Scott range of breathing apparatus from the Professional Fire Fighting SCBA through to the Airline and escape breathing apparatus range.



SCBA

3M™ Scott™ ProPak-EZ-Flo SCBA

ProPak-EZ-Flo provides firefighters a simple-to-use SCBA which can be upgraded to include communications and situational awareness.



3M™ Scott™ ProPak-i SCBA

The ProPak-i SCBA is suitable for providing respiratory protection in any IDLH environment, including industrial and firefighting applications.



Thermal Imagers

3M™ Scott™ Sight Hands free, in-mask thermal imaging system

The Scott Sight is a thermal in-mask imaging system, which integrates a lightweight camera and display in the fire-fighters mask, keeping the thermal image in view whilst in use.



3M™ Scott™ X380 Thermal Imager

The X380 Thermal Imager provide firefighters with a combination of situational awareness, lightweight design and key features. The high resolution and image quality enables firefighters to fully interpret a fire scene and make more informed tactical decisions.







Welding Protection

Guided by welders, trusted by welders.

The 3M™ Speedglas™ brand is the world's leading product line of welding safety and is a vital part of 3M's diverse range of personal protective equipment. More than 35 years ago, we went to the shipyards of Sweden to observe welders. They blindly struck arcs as they continually nodded their helmets down. They got accidentally flashed by other welders – or even themselves. We asked, "What if... welders could always see, even with their helmets down?" Since then, we've been systematically addressing every welding ergonomic challenge you face.

Subscribe to www.youtube.com/3MSpeedglas

Join the welding community on www.facebook.com/3MSpeedglas

Tag us on Instagram @3MSpeedglas



 **Speedglas™**
Welding Safety

3M™ Welding Protection

Choose your 3M™ Speedglas™ Welding Helmet



Welding helmet features	G5-01	9100	9100-Air	9100-QR	9100 FX	9100 FX-Air
Eye and Face Protection	EN 175:B, EN 379, EN 166:BT	EN 175:B, EN 379, EN 166:BT	EN 175:B, EN 379, EN 166:BT	EN 175:B, EN 379, EN 166:BT	EN 175:B, EN 379, EN 166:BT	EN 175:B, EN 379, EN 166:BT
Head protection	N/A	N/A	N/A	EN 397*	EN 397**	N/A
Respiratory protection	Powered or supplied air	Disposable or reusable respirator	Powered or supplied air	Disposable or reusable respirator	Disposable or reusable respirator	Powered or supplied air
Hearing protection options	NO	YES	YES	YES	YES	YES
1 Exhaust vents	N/A	YES	N/A	YES	YES	N/A
2 Side windows	NO	Optional	YES	YES	YES	YES
3 High-comfort headband	YES	YES	YES	N/A	YES	YES
4 Flip-up with clear visor	YES	NO	NO	NO	YES	YES
Part No additional coverage: Flame-retardant head cover	#169023	#169005	#169005	NO	#169007	#169007
Reflective helmet cover	#169021	NO	NO	NO	NO	NO
Flame-retardant neck protection	#169041	#169010	#169010	NO	#169010	#169010
Flame-retardant hood	#169035	#169100	#169100	#169100	#169100	#169100
Ear and neck cover in leather	#169042	#164005	#164005	#164005	#164005	#164005
Welding filter options	ADF: G5-01VC, G5-01TW	ADF: 9100V, 9100X, 9100XX, 9100XXi Passive	ADF: 9100V, 9100X, 9100XX, 9100XXi Passive	ADF: 9100V, 9100X, 9100XX, 9100XXi Passive	ADF: 9100V, 9100X, 9100XX, 9100XXi Passive	ADF: 9100V, 9100X, 9100XX, 9100XXi Passive

* with 3M™ Safety Helmet H-701.

** with 3M™ Safety Helmet G-3001 (adapter #197136 is needed).



1 Exhaust vents – exhaled air is channeled out via side exhaust vents.



2 Side windows – shade 5 filters that widen your field of vision.



3 Adjustable high-comfort headband.



4 Big, curved 17 × 10 cm clear protective visor, increasing your peripheral vision.



	9100 MP	9100 MP-Lite	9002NC	SL	100	100-QR
	EN 175:B, EN 379, EN 166:BT	EN 175:B, EN 379, EN 166:BT	EN 175:B, EN 379, EN 166:BT	EN 175:F EN 379, EN 166:FT	EN 175:B, EN 379, EN 166:BT	EN 175:B, EN 379, EN 166:BT
	EN 397	EN 812	N/A	N/A	N/A	EN 397*
	Powered or supplied air	Powered or supplied air	Disposable or resusable respirator	Disposable or resusable respirator	Disposable or resusable respirator	Disposable or resusable respirator
	YES	YES	YES	YES	YES	YES
	N/A	N/A	YES	NO	NO	NO
	YES	YES	NO	NO	NO	NO
	N/A	N/A	YES	YES	YES	N/A
	YES	YES	NO	NO	NO	NO
	NO #169014 #169015 #169100 #164005	NO #169014 #169015 #169100 #164005	#164009 NO #169001 #169100 #164005	NO NO #169001 #169100 #164005	#164009 NO #169001 #169100 #164005	NO NO #169001 #169100 #164005
	ADF: 9100V, 9100X, 9100XX, 9100XXi Passive	ADF: 9100V, 9100X, 9100XX, 9100XXi Passive	ADF: 9002NC	ADF: SL	ADF: 100-V Passive	ADF: 100-V Passive



Still seeing green?

Imagine what more realistic-looking colours and details could do for you:

- Provide better control of your weld puddle – with a view that appears lighter, brighter, and more realistic
- Help you focus on your welding set-up, welding technique, and inspection of just-completed welds
- Give you a clearer view of coloured welding machine controls – even with your helmet in the safe, down position

See the difference!

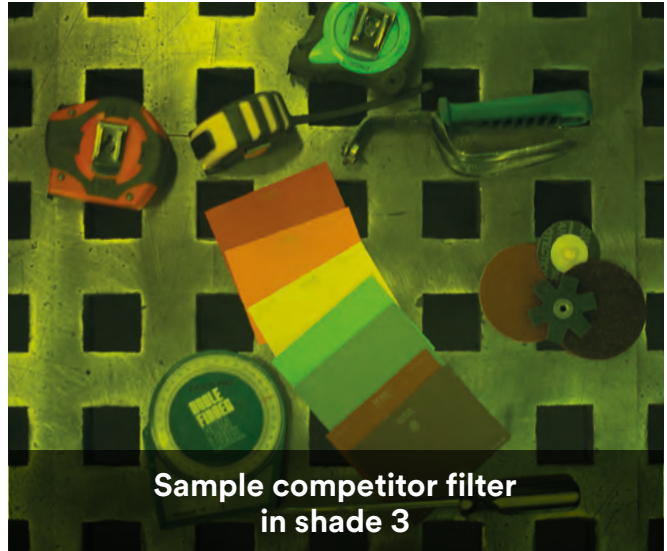

Sample competitor filter in shade 3



9100XXi and 9002NC filters in shade 3



“

The view seems lighter and less green – I can see colours far better! Even in the dark state, I see contours better.

”

Veteran welder

Select 3M™ Speedglas™ Welding Filter

Before you select welding filter, ask yourself:

- How will I use my welding filter?
- Do I occasionally change welding process/shade no.?

There are a few parameters that affects the performance of an auto-darkening filter like type of welding machine, working environments etc. The table below is a general guide to all our various models due to detector function and based solely on welding applications.

	Best*	Better*	Good*	Not recommended*					
Specification	G5-01TW	G5-01VC	9100XXi	9100XX	9100X	9100V	SL	100V	9002NC
MMAW (electrode)									
MIG/MAG									
TIG (>20A)									
TIG (1A-20A)									
Plasma (welding and cutting)									
Risk for hidden arc									
Tack welding									
Grinding									
Viewing area	73×109 mm		73×107 mm		55×107 mm	45×93 mm	42×93 mm	44×93 mm	55×107 mm
Battery lifetime	1500 hours		1800 hours	2000 hours	2500 hours	2800 hours	1500 hours		2000 hours
Solar cell	No		No		Yes		No	No	
Classification	1 / 1 / 1	2 / 2 / 2		1 / 1 / 1			1 / 1 / 1	1 / 2 / 2	1 / 1 / 1
Dark state	Shade 8-13	Shade 8-14		Shade 5, 8, 9-13			Shade 8-12		
Light state	Shade 3		Shade 3						
UV/IR Protection	Shade 13 (permanent)	Shade 14 (permanent)		Shade 13 (permanent)			Shade 12 (permanent)		
Auto ON	Yes		Yes	No			Yes	No	
Sensitivity of arc switching time, light -dark	0,1 ms (+23° C)								
Memory mode	Yes, via mobile device app		Yes	No					
Delay switching time, dark-light	50-1300 ms		40-800 ms		40-1300 ms		60-250 ms	40-250 ms	60-400 ms
Number of sensors (arc detection)	4		3				2		
Approval (welding filter)	EN 379		EN 379						
3M™ Speedglas™ Natural Colour Technology	Yes		Yes	No				Yes	

* The ratings (good - better - best) above refer to the products listed in this chart and should be seen as general recommendations based on differences in product comfort features and configuration options when using these selected Speedglas welding helmet series.

3M™ Welding Protection

3M™ Speedglas™ Welding Helmet SL with welding filter.

At a mere 370 grams – including its auto-darkening filter – the 3M™ Speedglas™ Welding Helmet SL is 25% lighter than any other Speedglas model. Using specialised manufacturing techniques, we greatly reduced the weight of the auto-darkening filter. And unlike other lightweight helmets that can absorb moisture and become heavy, the Speedglas helmet SL is made from a strong, non-absorbent material.

Designed specifically for quick welding tasks, a motion sensor automatically turns ON the welding filter when you pick up the helmet.



Speedglas™
Welding Safety

Features and Benefits:

- Light in weight, strong in performance
- Five adjustable dark shades 8–12 and a light shade of 3
- Four sensitivity settings
- Appropriate for most arc welding processes – such as MMA, MIG/MAG, TIG and plasma welding
- A motion sensor automatically turns ON the welding filter when you pick up the helmet
- Compatible with most 3M™ Filtering Facepiece Respirators
- Easy tightening: The head suspension features a smooth ratchet for easy tightening – even while wearing gloves!



3M™ Speedglas™ Welding Helmet SL with welding filter.

Part Number 70 11 20

When your #1 priority is super light

Technical specifications on page 148-149.



reddot design award
winner 2007



product
design
award

2008



3M™ Speedglas™ Welding Helmet 100 Black with 100V filter

The easy-to-use 3M™ Speedglas™ Welding Helmet Series 100 allows you to take advantage of excellent optical quality and reliable light-to-dark switching at a highly affordable price.



Speedglas™
Welding Safety

In addition to the black model, you can choose from several highly expressive graphic helmet designs.

Features and Benefits:

- 3M™ Speedglas™ Welding filter 100V: five adjustable dark shades 8-12 and a light shade of 3
- Three sensitivity settings
- Speedglas Welding filters 100S-10 and 100S-11 have single dark shades of 10 and 11 respectively, and a light shade of 3
- For grinding, lock-in shade 3 light state. Only applicable for the welding filter 100V
- High impact rating according to the requirements of the European Standard EN 175:B
- Appropriate for most arc welding processes, including MMA and MIG/MAG. The welding filter 100V is also appropriate for high amp TIG welding
- Compatible with most 3M™ Filtering Facepiece Respirators



3M™ Speedglas™ Welding Helmet 100 Black with 100V filter

Part Number: 75 11 20

High-end features, low-end price

Technical specifications on [page 148-149](#).

Make a visual impact



3M™ Welding Protection

3M™ Speedglas™ Auto-Darkening Filter 9100XXi

Introducing a new solution in our range of top-of-the-line auto-darkening filters: The 3M™ Speedglas™ Auto-Darkening Filter 9100XXi offers the same large viewing area as our 9100XX welding filter.



Speedglas™
Welding Safety

See the difference: improved optics in the new 9100XXi filter provide more contrast and natural-looking colours, as shown by these two photos. The photo below is shot through the 9100XXi welding filter.

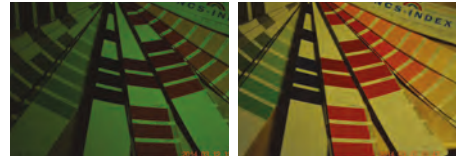

9100XXi vs 9100XX in color

Features and Benefits:

- Fast switching between welding and grinding
- Seven dark shades, including 9-13 (variable), 5 for gas welding/cutting, and 8 for micro-plasma or low-amp TIG (even on settings as low as 1 amp)
- Auto ON/OFF - A new motion-sensor instantly turns ON the welding filter when you pick up the helmet
- Large viewing area 73×107 mm



More natural colours

The difference is easy to see. Yes, the light state is still shade 3! In fact, the improved welding filter optics can make your entire viewing experience feel more natural.



External controls and memory function

With a push of an external button, switch between grinding mode or your two memory settings for welding. You do not even have to take off a glove!

3M™ Speedglas™ Auto-Darkening Filter 9100XXi

Seeing is believing

Technical specifications on page 148-149.



Easy Upgrade

The 9100XXi ADF is compatible with all welding helmets in the 3M™ Speedglas™ Welding Helmet Series 9100. However, to access the grinding and memory modes, the silver front panel included in the 3M™ Speedglas™ Auto-Darkening Filter Kit 9100XXi is required. This panel will only operate on Speedglas Welding Helmets 9100, 9100-Air and 9100-QR.



Watch the videos at
www.youtube.com/3MSpeedglas

3M™ Speedglas™ Welding Helmet 9100 with Side Windows and welding filter 9100XXi

Protecting your eyes and face from radiation, heat and sparks - while providing a precise view of your work - makes your 3M™ Speedglas™ Welding Helmet 9100 one of your most important welding tools.



Speedglas™
Welding Safety

All of these benefits can be used with powered or supplied air respiratory protection in combination with the Speedglas welding helmet 9100-Air. If your work situation requires head protection, test out our Speedglas welding helmet 9100-QR. It quickly attaches to many of the industry's most popular safety helmets, including the 3M™ Safety Helmet H-701.

Features and Benefits:

- **Simplified workflow:** The 9100XXi kit (special front and welding filter) houses external controls – enabling convenient, “gloves-on” memory mode switching – to help you weld, grind and see your finish.
- High-comfort 3M™ Speedglas™ Headband
- Large coverage for ear and side of head
- Side windows: Shade 5 filters that widen your field of vision
- Meets the requirements of mechanical resistance to high speed particles according to EN 175 class B
- 100% compatible with our top-of-the-line series of 3M™ Speedglas™ Welding Filter Series 9100
- Exhaust vents readily direct exhaled air out of the helmet, reducing likelihood of a foggy welding filter (9100 and 9100-QR)



Tailor to fit your personal preferences
With the 9100 headband, we've carefully avoided sensitive areas of the head while designing self-adjusting twin pads for the forehead band. By better contouring it around your head, our headband doesn't need to be overly tight to be comfortably secure on your head.

3M™ Speedglas™ Welding Helmet 9100 with Side Windows and welding filter 9100XXi
Part Number: 50 18 26
3M™ Speedglas™ Natural Colour Technology.

For other welding filter options and technical specifications please check [page 148-149](#).



3M™ Speedglas™ Welding Helmet 9100-QR with welding filter 9100XXi
Part Number: 58 36 26
3M™ Speedglas™ Quick Release (QR) Rail.
3M™ Speedglas™ Natural Colour Technology.

For other welding filter options and technical specifications please check [page 148-149](#).



3M™ Speedglas™ Welding Helmet 9100-Air with welding filter 9100XXi and 3M™ Adflo™ Powered Air Respirator.
Part Number: 56 7726
3M™ Speedglas™ Natural Colour Technology.
Also available with supplied air regulator.

For other welding filter options and technical specifications please check [page 148-149](#).



reddot design award
best of the best 2009



product design award
2009

3M™ Welding Protection

3M™ Speedglas™ Welding Helmet 9100 FX with welding filter 9100XXi

3M™ Speedglas™ Welding Helmet 9100 FX, a flip up combination of an auto-darkening welding helmet and a protective visor.

A quick lift of the front and you get a big, 17 × 10 cm clear view – perfect for precision grinding in low-light conditions. And if you use the 9100 FX-Air model, the clear view from the curved visor lets you keep your respiratory protection in place at all times.



Speedglas™
Welding Safety

Features and Benefits:

- Side windows: Shade 5 filters that widen your field of vision
- The big, 17×10 cm clear protective visor is curved, increasing your peripheral vision
- High-comfort 3M™ Speedglas™ Headband 9100
- Exhaled air is channelled out via side exhaust vents
- Meets the requirements of mechanical resistance to high speed particles according to EN 175:B and EN 166:B
- 100% compatible with our top-of-the-line series of 3M™ Speedglas™ Welding Filter Series 9100



3M™ Speedglas™ Welding Helmet 9100 FX with welding filter 9100XXi

Part Number: 54 18 26

Wider field of view with flip-up front 3M™ Speedglas™ Natural Colour Technology.

For other welding filter options and technical specifications please check [page 148-149](#).



3M™ Speedglas™ Welding Helmet 9100 FX-Air with welding filter 9100XXi and 3M™ Adflo™ Powered Air Respirator

Part Number: 54 18 26

TH3-rated respiratory protection. 3M™ Speedglas™ Natural Colour Technology.

For other welding filter options and technical specifications please check [page 148-149](#).



Safety Helmet Adapter

Using the safety helmet adapter, you can easily fit many of the industry's safety helmets with the Speedglas welding helmet 9100 FX. Part number: 19 71 36
3M also offers this complete welding helmet system including the 3M™ Safety Helmet G-3001.



reddot design award
winner 2012



3M™ Speedglas™ Welding Helmet 9002NC, including welding filter

You asked and we listened. Many welders consider our classic Speedglas 9000 model an excellent balance of helmet shape, size, and weight for their application. So we've brought it back. The exact same shell profile many welders love. But we added new, high performing optics – and a headband made for increased comfort.



Speedglas™
Welding Safety

Introducing the 3M™ Speedglas™ Welding Helmet & Auto-Darkening Filter 9002NC.

Features and Benefits:

• Better control

An improved optical experience, with a view that appears lighter, brighter, and more realistic. Viewing your weld puddle with the new 3M™ Speedglas™ Natural Colour Technology can help give you better control over your welds.

• Exhale

Thanks to the exhaust vents built into the helmet, the build-up of carbon dioxide is reduced compared to traditional helmet designs.

• Freedom of movement

The slim helmet's design increase freedom of movement. Plus, the exhaust vents allow for a close-to-the-face fit.

• Affordable price

Puts 3M™ Speedglas™ Technology and state-of-the-art auto-darkening optics within reach of every welder, from apprentices to seasoned veterans.



3M™ Speedglas™ Welding Helmet 9002NC, including welding filter

Part Number: 40 13 85

3M™ Speedglas™ Natural Colour Technology.

Technical specifications on page 148-149.



Improved comfort

Adjust to the right headband setting, so your helmet stays where you want it.



3M™ Welding Protection

3M™ Speedglas™ Welding Helmet 9100 MP with welding filter 9100XXi and 3M™ Adflo™ Powered Air Respirator

We've seamlessly integrated five levels of welder protection: head, eye, face, respiratory and hearing into one extraordinarily comfortable and easy-to-use system. The 3M™ Speedglas™ Welding Helmet 9100MP (Multi Protection): uncompromising, all-in-one, welding protection for highly demanding environments.



Speedglas™
Welding Safety

Features and benefits:

- A big (17×10cm) curved protective visor with excellent views up, down and peripherally
- Meets EN 166:BT for high speed particle protection*
- Respiratory protection - TH3**
- The top shell is made from heat resistant polycarbonate and meets the standard EN397 for industrial safety helmets
- An optional high visibility, aluminium fabric reflects hot sunlight and welding heat
- Two shade 5 passive side windows add peripheral welding vision
- Designed from inception to accept 3M™ PELTOR™ Earmuffs
- It readily connects to both 3M™ Adflo™ Powered Air Respirator and 3M™ Versaflo™ Supplied Air Regulator V-500E



Designed from inception to accept 3M™ PELTOR™ Earmuffs

3M™ Speedglas™ Welding Helmet 9100 MP with welding filter 9100XXi and 3M™ Adflo™ Powered Air Respirator

Part number: 57 77 26

Multiple protection for welders

3M™ Speedglas™ Natural Colour Technology.

For other welding filter options and technical specifications please check **page 148-149**.



3M™ Speedglas™ Welding Helmet 9100 MP-Lite with 3M™ Adflo™ Powered Air Respirator

Part Number 57 85 00

Same features and options as the 9100 MP system, but with a bump cap that is approximately 20% lighter than our safety helmet version.

For welding filter options and technical specifications please check **page 148-149**.



* European Standards classify this visor as "B," with resistance to high speed particles at medium energy impact (120 m/s).

** When used with 3M™ Adflo™ Powered Air Respirator

3M™ Adflo™ Powered Air Respirator

Since its launch, 3M™ Adflo™ Powered Air Respirator has become one of the most popular powered air respirators in the world.



Speedglas™
Welding Safety

The Adflo powered air respirator is specifically designed to meet your welding needs. Its continuous airflow provides filtered air that takes much of the heat and sweat out of welding. By using the Adflo respirator, you get both increased protection and comfort all day long.

Features and benefits:

- The slim profile and ergonomic design make it easier to go into tight welding spaces and offers the quality and functions you should expect from a robust and easy-to-use respiratory system
- With the right type of filter, the Adflo respirator effectively protects against both particles and gases - all in one system
- Selectively replace either the particle or the gas filter as needed: you don't need to change both filters at the same time
- The new Li-ion batteries makes the turbo more lightweight and balanced for even greater comfort during the full shift
- The airflow is always a constant nominal rate of 170 litres per minute, regardless of the battery's charge or the particle loading of the filter
- For hot, humid jobs, you can increase the airflow to 200 litres per minute by simply pushing the ON button a second time



3M™ Adflo™ Powered Air Respirator

An adaptable system that saves money

If you are using an older Adflo respirator, you can easily upgrade to a new level of performance incorporating Li-ion battery, making the turbo almost 20% lighter.



Go higher

At higher altitudes, air is less dense. To compensate, we offer the 3M™ Adflo™ High Altitude Powered Air Respirator. Suitable for 0 to 3000 meters above sea level, or 0 to 1500 metres with gas filters.

3M™ Welding Protection

3M™ Speedglas™ Welding Helmet G5-01

3M™ Speedglas™ Welding Helmet G5-01 is specifically designed for the heavy duty welder. The helmets flip-up functionality allows you to seamlessly switch between welding and grinding tasks while maintaining powered air respiratory protection.

Highly customisable adjustment settings, including more control over how you see your weld pool; how air is directed within your respiratory helmet; and how you configure the helmet for added protection against radiation, sparks, and spatter.

Features and Benefits:

- Flip-up auto-darkening welding filter, combined with a clear, wide (170x104 mm) protective visor
- Speedglas™ Natural Colour Technology
- Speedglas™ Variable Colour Technology (G5-01VC)
- Tack Welding mode (G5-01TW)
- Air flow control
- Optional task light
- New headband design
- 3M Connected Equipment App



Speedglas™
Welding Safety

Typical Applications

- Most welding processes such as: MMA (Stick), MIG/MAG, TIG, Low amp TIG
- Cutting
- Grinding

3M™ Speedglas™ Welding Helmet G5-01
Classification: Class TH3 CE NPF 500

Welding filter options:

3M™ Speedglas™ welding filter G5-01VC

- Adjustable dark shades 5 (cut) and 8 to 14
- Variable colour technology



3M™ Speedglas™ welding filter G5-01TW

- Adjustable dark shades 5 (cut) and 8 to 13
- Tack Welding Mode



reddot design award
winner 2012



Body Protection





Protective Apparel

Differential Permeation. Applied to returning you home safely.

At 3M we have a select and high quality range of CE Certified products from CE simple coveralls to PPE Directive Category III Coveralls, which provide protection against many hazards.

The range of 3M™ Protective Apparel offers a variety of features, from the use of fabrics with specialist treatments for enhanced wear and added protection, to breathable back panels for increased comfort. Our experts can work closely with you, to help you identify hazards and best protect your workers against them.









3M™ Protective Apparel

Standards

There are many tests and standards that apply to protective coveralls and selection can be a daunting task. The following section outlines the different options available to help you select the right product for your employees. For more information on how the tests are done, and what they mean practically to you, review the technical bulletins and guides within our 3M protective apparel literature.





Protection Types

Depending on the materials and construction protective coveralls can be designed for either hazardous applications (certified to CE Category III) or non-hazardous applications (approved as CE Simple Category 1). Products for hazardous applications can be tested and certified to any of six different “Type” standards providing guidance on suitability of use:

Category	Symbol	Protection Type	Standard	3M Products
CE Category III 		1 – Gas Tight	EN 943-1	N/A
		2 – Non-gas tight	EN 943-1	N/A
		3 – Liquid Jet Protection	EN 14605 + A1	4570
		4 – Liquid Spray Protection	EN 14605 + A1	4570, 4565
		5 – Hazardous Particulate Protection	EN ISO 13982	4570, 4565, 4545, 4540+, 4535, 4532+, 4530, 4520, 4515, 4510
		6 – Liquid Splash Protection	EN 13034 + A1	
CE Category I		CE Simple		4500

Additional Standards

Some 3M™ Protective Coveralls and their materials are approved to additional standards for specialist applications.

Symbol/Standard	Protection Type
	Protection against micro-organisms or infective agents (EN 14126:2003)
	Protection against nuclear particles (EN 1073-2:2002)
	Anti-static (EN 1149-5:2008)
ISO 15025 / ISO 14116	Limited Flame Spread Resistance
	Where added to the above symbols please refer to the appropriate user instructions for further information on the compliance of this product



3M™ Protective Apparel

Materials

The following is a guide that offers a brief description and comparison of the materials used in 3M's protective coverall range. Base materials can be treated, for instance, with an anti-static treatment, to enhance the total protection offered.

Non-woven Polypropylene

Offers comfortable light-duty protection against nonhazardous liquids and dust.

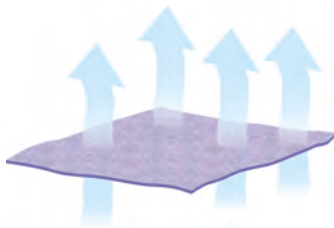

Spunbond-Meltblown Polypropylene (SMS)

'SMS' can be layered differently to adjust the protective and physical properties of the material. Standard SMS-material is very breathable and offers a good barrier against dusts and limited liquid splashes. If treated materials can achieve an enhanced level of splash protection, such as the 3M™ Protective Coverall 4532+.

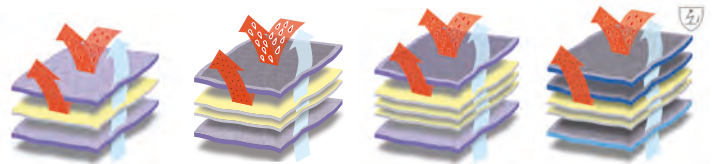

Microporous Laminates

'Microporous laminates' offer a higher level of liquid splash protection, while the micropores allow for some breathability.

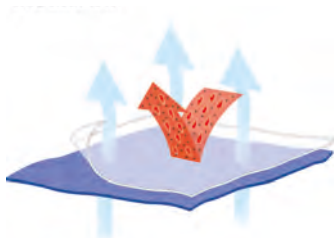

Non-microporous Laminates

'Non-microporous laminates' can offer an even higher level of liquid protection. Adding multiple layers of the laminate can also increase robustness and chemical holdout.



Design Features

3M™ Protective Coveralls can offer a variety of features depending on your needs. The illustration below highlights some of the features available:



3M™ Protective Apparel

3M™ Coverall 4500

The 3M™ Coverall 4500 is a CE Simple suit designed and suitable for non-hazardous applications.

Whether it is for domestic DIY use, light duty industrial cleaning and maintenance applications or environments where hygiene and cleanliness are important, the 3M coverall 4500 is an excellent economic solution to help keep wearers clean and protected from light non hazardous splashes.

Typical Applications

Popular Choice

- Light duty cleaning
- Warehousing
- Janitorial
- Domestic DIY

Features and Benefits:

- Breathable and light duty protection
- Strong, durable 45gsm polypropylene fabric
- Storm flap over zip
- Elasticated hood, cuffs, ankles and waist
- Available in blue and white
- Serged seams



3M™ Coverall 4500

Colour: White and blue

CE Category I

Sizes: S-4XL



Fabric material

The material used in the 3M coverall 4500 is a soft breathable polypropylene, which aids air flow helping reduce heat stress and improve comfort. The comfortable coverall for non-hazardous protection.

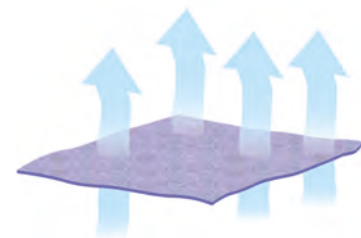

Seam Technology

Seams are serged for Type 5/6 protection.

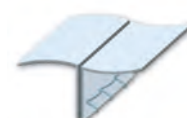

3M™ Protective Apparel

3M™ Protective Coverall 4510



The 3M™ Protective Coverall 4510 is an economic solution which offers quality and protection from limited chemical splashes such as those from paint spraying and is certified to the PPE Directive Category III, Type 5/6 protection standard. The material is microporous, allowing air and moisture to escape from within the suit, while helping to protect from the hazard on the outside.

Typical Applications

Popular Choice

- Light industrial cleaning
- Machine maintenance
- Paint spraying & powder coating
- Coating & resin applications
- Crime scene investigation

Suitable for Consideration

- Asbestos inspection and removal
- Site preparation, insulation.
- Cement manufacturing
- Grinding & polishing
- Pharmaceutical processing & handling toxic powders
- Cleanrooms

Features and Benefits:

- Excellent barrier against dry particles and certain limited liquid chemical splash (CE Type 5/6)
- Laminated microporous material
- 2-way zipper with storm flap for added on-off convenience and extra protection
- Elastic cuffs, waist and ankles for a better fit and freedom of movement
- Super low-linting
- Anti-static treatment to EN 1149 to reduce charge build up
- Meets inward leakage requirements of EN 1073-2 for protection against nuclear particles
- Biological protection tested to EN 14126



3M™ Protective Coverall 4510 Type 5/6

Colour: White

CE Category III

Sizes: S-4XL



Fabric material

The anti-static treated 3M protective coverall 4510 material is made using a layer of soft, spunbond polypropylene and a layer of light, but high quality polyethylene laminate film giving good levels of barrier efficiency and protection.

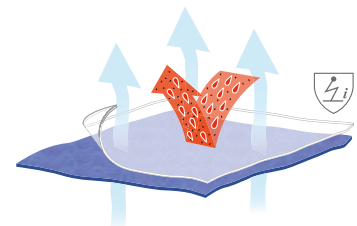

Seam Technology

Seams are serged for Type 5/6 and certain seams bound for extra protection.

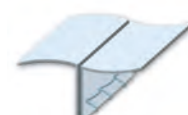

3M™ Protective Apparel

3M™ Protective Coverall 4515



Low cost hazardous dust protection

The 3M™ Protective Coverall 4515 is an economic solution to protect from hazardous dusts such as asbestos fibres exposed to during site inspection. While protecting on the outside, the breathable material allows air to escape from the inside to reduce heat build-up and discomfort. Available in white, blue and orange, the range is certified to PPE Directive Category III, Type 5/6 protection for both hazardous dusts and liquid splashes.

Typical Applications

Popular Choice

- Asbestos inspection
- Site preparation, insulation
- Construction

Suitable for Consideration

- Cement manufacturing
- Grinding & polishing
- Light industrial cleaning
- Machine maintenance

Features and Benefits:

- Excellent barrier against dry particles and limited liquid splash (CE Type 5/6)
- Meets inward leakage requirements of EN 1073-2 for protection against nuclear particles
- Robust, highly breathable 50gsm SMS material
- 2-way zipper with storm flap for added on-off convenience and extra protection
- Elastic cuffs, waist and ankles for a better fit and freedom of movement
- Low-linting
- Available in white, blue and orange



3M™ Protective Coverall 4515 Type 5/6

Colour: White, blue and orange

CE Category III

Sizes: S-4XL



Fabric material

The material used in the 3M protective coverall 4515 sandwiches a single thick filtering layer of melt-blown polypropylene between two thinner layers of softer spun bond polypropylene delivering a finished durable, breathable 50gsm protective material that aids air flow to reduce heat stress and improve comfort.

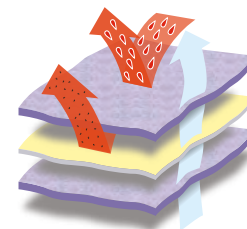

Seam Technology

Seams are serged for Type 5/6 protection.

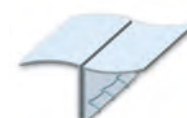

3M™ Protective Apparel

3M™ Protective Coverall 4520



Made using the latest lightweight, breathable material technology, 3M presents the 3M™ Protective Coverall 4520, a PPE Directive Category III, Type 5/6 protective garment.

Typical Applications

Popular Choice

- Asbestos inspection
- Site preparation, insulation
- Pharmaceutical processing and handling toxic powders

Suitable for Consideration

- Asbestos removal
- Cement manufacturing
- Grinding & polishing
- Light industrial cleaning
- Machine maintenance
- Construction work
- Light paint spraying/powder coating

Features and Benefits:

- Excellent barrier against dry particles and limited liquid splash (CE Type 5/6)
- SMMMS material technology for reduced heat stress and breathable comfort all day
- Low-linting
- Extremely lightweight and comfortable compared to many certified coveralls available in the marketplace
- 3-panel elasticated hood for enhanced compatibility with complimentary PPE
- Knitted cuffs and elasticated waist and ankles for increased comfort and freedom of movement
- 2 way zipper with stormflap for added convenience and extra protection
- Anti-static treatment to EN 1149 to reduce charge build up
- Meets inward leakage requirements of EN 1073-2 for protection against nuclear particles
- Model with elasticated cuffs and thumbloop also available



3M™ Protective Coverall 4520 Type 5/6

Colour: White with green back panel

CE Category III

Sizes: S-4XL



Latest Material Technology

With 3 layers of melt-blown polypropylene in-between 2 layers of spunbound polypropylene, the 3M protective coverall 4520 fabric has been specifically designed to improve air flow and breathability, thereby reducing heat stress and enhancing comfort levels. The middle 3 layers act as a filter to effectively protect against hazardous dust and splash and the outer 2 layers offer strength and durability whilst maintaining a soft, comfortable feel.

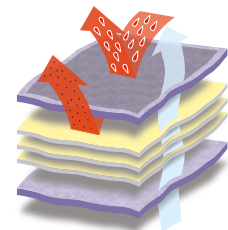

Seam Technology

Seams are serged for Type 5/6 protection.

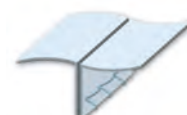

3M™ Protective Apparel

3M™ Protective Coverall 4520CS



Made using the latest lightweight, breathable material technology, 3M presents the 3M™ Protective Coverall 4520CS, a PPE Directive Category III, Type 5/6 protective garment.

With the same premium comfort and protection as the standard 3M protective coverall 4520, but with a standard collar for greater compatibility with Powered and Supplied Air Respirators.

Typical Applications

Popular Choice

- Asbestos inspection
- Site preparation, insulation
- Pharmaceutical processing and handling toxic powders

Suitable for Consideration

- Asbestos removal
- Cement manufacturing
- Grinding & polishing
- Light industrial cleaning
- Machine maintenance
- Construction work
- Light paint spraying/powder coating

Features and Benefits:

- Excellent barrier against dry particles and limited liquid splash (CE Type 5/6)
- SMMMS material technology for reduced heat stress and breathable comfort all day
- Extremely lightweight and comfortable compared to many certified coveralls available in the marketplace
- Low-linting
- Collar standard neck finish for when a hood is not required or interferes with alternative head, face or respiratory protection
- Knitted cuffs and elasticated waist and ankles for increased comfort and freedom of movement
- 2 way zipper with stormflap for added convenience and extra protection
- Anti-static treatment to EN 1149 to reduce charge build up
- Meets inward leakage requirements of EN 1073-2 for protection against nuclear particles



3M™ Protective Coverall 4520CS Type 5/6

Colour: White with green back panel

CE Category III



Sizes: M-2XL



Latest Material Technology

With 3 layers of melt-blown polypropylene in-between 2 layers of spunbound polypropylene, the 3M protective coverall 4520 fabric has been specifically designed to improve air flow and breathability, thereby reducing heat stress and enhancing comfort levels. The middle 3 layers act as a filter to effectively protect against hazardous dust and splash and the outer 2 layers offer strength and durability whilst maintaining a soft, comfortable feel.

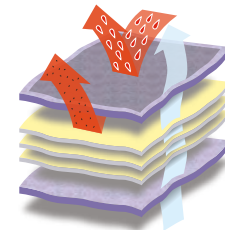

Seam Technology

Seams are serged for Type 5/6 protection.

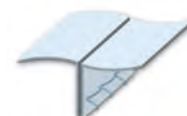

3M™ Protective Apparel

3M™ Protective Coverall 4530



The 3M™ Protective Coverall 4530 is a PPE Directive, CE Category III, Type 5/6 protective garment, made from a breathable SMMS material technology and includes a host of comfort features. The material also has a flame resistance treatment, which allows the fabric to perform to ISO 14116 Index 1*.

Typical Applications

Popular Choice

- Metal grinding and polishing
- Oil & Gas industry
- Cement manufacturing
- Welding

Suitable for Consideration

- Asbestos inspection and removal
- Site preparation and insulation
- Light industrial cleaning
- Machine maintenance
- Pharmaceutical processing
- Handling toxic powders
- Painting and coating

Features and Benefits:

- Excellent barrier against dry particles and certain limited liquid chemical splash (CE Type 5/6)
- Limited flame spread resistance to ISO 14116 Index1/0 (material only)
- Highly breathable robust 54gsm SMMS material
- 3-panel elasticated hood for enhanced compatibility with complimentary PPE
- 2-way zipper with sealable storm flap for added on-off convenience and extra protection
- Knitted cuffs and elastic waist and ankles for a better fit and freedom of movement
- Enhanced triangular gusset panel
- Low-linting
- Anti-static treatment to EN 1149 to reduce charge build up
- Meets inward leakage requirements of EN 1073-2 for protection against nuclear particles
- Available in blue (with white triangle) and white



3M™ Protective Coverall 4530 Type 5/6

Colour: Blue with white back panel

CE Category III



Sizes: M-4XL



Fabric Material

With layers of Meltblown polypropylene in between 2 layers of spun bond polypropylene the 3M protective coverall 4530 fabric allows airflow, increasing breathability, reducing heat stress and improving comfort. The melt blown layers are inserted with hot air and act as a barrier while the two outer spun bond layers make the coverall soft and breathable.

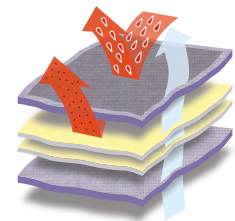

* The additional flame spread resistance treatment enables the material to give limited flame spread protection (ISO 14116) when worn over an Index 2 or 3 garment. This may extend the life of the more expensive thermal protective garments.

Seam Technology

Seams are serged for Type 5/6 protection.

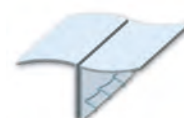

3M™ Protective Apparel

3M™ Protective Coverall 4532+



The 3M™ Protective Coverall 4532+ range is made from a highly breathable and lightweight 5 layered SSMMS material, providing the wearer with CE Category III, Type 5/6 protection with specialist treatments providing anti-static protection and an enhanced liquid repellency.

Typical Applications

Popular Choice

- Metal grinding and polishing
- Oil/greasy environments
- Painting and coating
- Cement manufacturing

Suitable for Consideration

- Light industrial cleaning
- Machine maintenance
- Pharmaceutical processing
- Handling toxic powders
- Resin applications

Features and Benefits:

- Specialist coatings enable this product to be used in many applications not usually suitable for SMS Based coveralls
- SSMMS material, see Fabric Material
- 3-panel elasticated hood for enhanced compatibility with complimentary PPE
- Knitted cuffs and elasticated waist and ankles
- 2-way zipper for added convenience and a storm flap with full sealable tape for extra protection
- Enhanced and reinforced triangular gusset panel to increase product durability
- Anti-static treatment to EN 1149 to reduce charge build up
- Meets inward leakage requirements of EN 1073-2 for protection against nuclear particles
- Low linting
- Available in blue (with a light blue triangle back panel) and Cool white



3M™ Protective Coverall 4532+ Type 5/6

Colour: Blue with with a light blue back panel and Cool white

CE Category III

Sizes: S-4XL



Fabric Material

The 3M protective coverall 4532+ is made using a 52gsm SSMMS, which consists of two outer layers of spunbond polypropylene (SS) encasing two layers of melt-blown polypropylene (MM) and a third layer of spunbond (S) on the underside. The fabric has been specifically designed to be durable whilst enabling air flow thereby reducing heat stress and enhancing wearer comfort. The middle 2 layers act as a filter to effectively protect against noxious dust and splash whilst the outer layers offer strength and increased liquid hold out from the alcohol and oil repellence treatment.

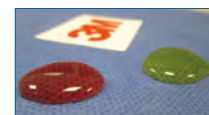
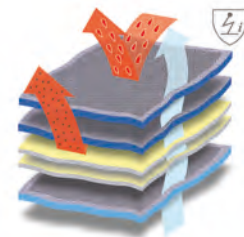

Unique treatment encourages the oil to bead rather than soak through.

Seam Technology

Seams are serged for Type 5/6 and certain seams bound for extra protection.



3M™ Protective Apparel

3M™ Protective Coverall 4535



If you're looking for a balance of protection, durability and additional comfort, look no further than the 3M™ Protective Coverall 4535. Certified to PPE Directive Category III, Type 5/6 protection, it utilises a dual material design with added comfort features and enhanced breathability to optimise wearer acceptance.

Typical Applications

Popular Choice

- Coating & resin applications
- Light industrial cleaning
- Machine maintenance
- Paint spraying & powder coating
- Forensics

Suitable for Consideration

- Asbestos inspection and removal
- Site preparation, insulation.
- Cement manufacturing
- Grinding & polishing
- Pharmaceutical processing and handling toxic powders

Features and Benefits:

- Excellent barrier against dry particles and certain limited liquid chemical splash (CE Type 5/6)
- Robust, super low-linting laminated microporous material
- Extra large breathable back panel for improved air circulation and reduced heat stress
- 2-way zipper with storm flap for added on-off convenience and extra protection
- Knitted cuffs with elasticated waist and ankles for increased comfort and freedom of movement
- Low-linting
- Anti-static treatment to EN 1149 to reduce charge build up
- Meets inward leakage requirements of EN 1073-2 for protection against nuclear particles



3M™ Protective Coverall 4535 Type 5/6

Colour: White with blue back panel

CE Category III



Sizes: S-3XL



Fabric Material

The front of the 3M protective coverall 4535 combines a high quality polyethylene laminate providing an excellent barrier, on top of a layer of soft, spunbond polypropylene fibres creating a robust, yet comfortable 55 gsm protective fabric. The large blue back panel is made from 5 layers of spunbond and meltblown polypropylene giving excellent breathability, whilst maintaining the Type 5/6 level of protection.

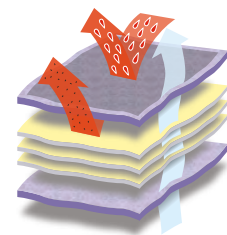

SMMMS back-panel.

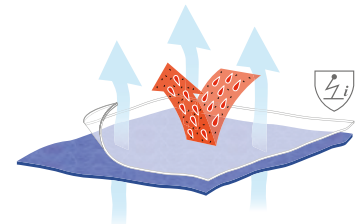

Microporous laminate fabric.

Seam Technology

Seams are serged for Type 5/6 and certain seams bound for extra protection.



3M™ Protective Apparel

3M™ Protective Coverall 4540+



With premium dual material technology and offering CE Category III, Type 5/6 protection, the 3M™ Protective Coverall 4540+ is ideal for applications where both high levels of protective performance and comfort are desired.

Typical Applications

Popular Choice

- Paint spraying & powder coating
- Coating & resin applications
- Light industrial cleaning
- Machine maintenance

Suitable for Consideration

- Asbestos inspection and removal
- Site preparation, insulation.
- Cement manufacturing
- Grinding & polishing
- Pharmaceutical processing and handling toxic powders

Features and Benefits:

- Excellent barrier against dry particles and certain liquid chemical splash (CE Type 5/6)
- Soft and light, super low-linting laminated microporous material that drapes and hangs well over the body facilitating ease of movement
- Back panel made of breathable SMMMS material for improved air circulation and reduced heat stress
- 2-way zipper with fully sealable storm flap for added on-off convenience and extra protection
- 3-panel hood design for enhanced compatibility with complimentary PPE
- Knitted cuffs and elasticated waist and ankles for increased comfort and freedom of movement
- Enhanced and reinforced triangular gusset panel to increase product durability
- Anti-static treatment to EN 1149 to reduce charge build up
- Meets inward leakage requirements of EN 1073-2 for protection against nuclear particles
- Low linting



3M™ Protective Coverall 4540+ Type 5/6

Colour: White with blue back panel

CE Category III

Sizes: S-4XL



Fabric Material

The front of the 3M protective coverall 4540+ combines a high quality polyethylene laminate providing an excellent barrier, on top of a layer of soft, spunbond polypropylene fibres creating a robust, yet comfortable 55gsm protective fabric. The blue back panel is made from 5 layers of spunbond and meltblown polypropylene giving excellent breathability, whilst maintaining the Type 5/6 level of protection.

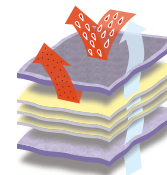

SMMMS back-panel.

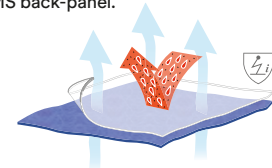

Microporous laminate fabric.

Seam Technology

Seams are serged for Type 5/6 and certain seams bound for extra protection.

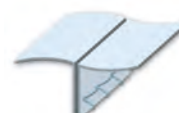

3M™ Protective Apparel

3M™ Protective Coverall 4545



The 3M™ Protective Coverall 4545 is designed to be comfortable, but highly protective certified to PPE Directive Category III, Type 5/6.

Designed like the 3M™ Protective Coverall 4540+ and using the same material as a single laminate suit, it is certified to protect against biological agents, radioactive particulates and is super low-linting, making it suitable for a wide range of applications including many cleanrooms.

Typical Applications

Popular Choice

- Light industrial cleaning
- Machine maintenance
- Paint spraying & powder coating
- Coating & resin applications
- Cleanrooms
- Forensics

Suitable for Consideration

- Asbestos inspection and removal
- Site preparation, insulation
- Cement manufacturing
- Grinding & polishing
- Pharmaceutical processing and handling toxic powders
- Metallurgy

Features and Benefits:

- Excellent barrier against dry particles and certain limited liquid chemical splash (CE Type 5/6)
- Biological protection tested to EN 14126
- Soft, well-draping, laminated microporous material
- 3-panel hood design for enhanced compatibility with complimentary PPE
- 2-way zipper with sealable storm flap for added on-off convenience and extra protection
- Knitted cuffs with elasticated waist and ankles for increased comfort and freedom of movement
- Enhanced and reinforced triangular gusset panel to increase product durability
- Super low-linting
- Anti-static treatment to EN 1149 to reduce charge build up
- Meets inward leakage requirements of EN 1073-2 for protection against nuclear particles
- Supplied in space saving vacuum packaging



3M™ Protective Coverall 4545 Type 5/6

Colour: White

CE Category III

Size: S-4XL



Fabric Material

The 3M protective coverall 4545. It is up to 20% lighter than previous 3M polyethylene laminate materials and is made from a 55gsm polypropylene and polyethylene laminate materials. It uses anti-static composite layer of soft, spunbond fibres and a layer of light, but high quality polyethylene laminate film, giving excellent levels of barrier efficiency and liquid protection.

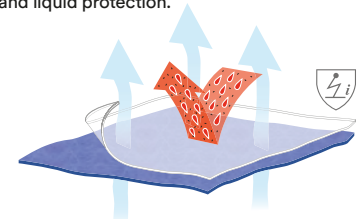

Seam Technology

Seams are serged for Type 5/6 and certain seams bound for extra protection.

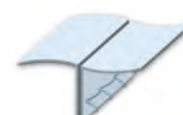

3M™ Protective Apparel

3M™ Protective Coverall 4565



Offering CE Category III, Type 4/5/6 protection, the 3M™ Protective Coverall 4565 has an impressive level of liquid barrier protection whilst maintaining its unique soft feel and well-fitting drape. With tape applied over the seams a greater level of total protection and seam durability is offered versus Type 5/6 products.

Typical Applications

Popular Choice

- Asbestos removal
- Pharmaceutical processing
- Handling toxic powders
- Cleanrooms
- Pesticide spraying

Suitable for Consideration

- Asbestos inspection
- Site preparation, insulation
- Cement manufacturing
- Grinding & polishing
- Industrial cleaning and maintenance
- Painting & coating, resins

Features and Benefits:

- Excellent barrier against dry particles, liquid certain chemical splash and spray (CE Type 4/5/6)
- Taped seams across the suit for better protection and increased durability
- Soft, well-draping laminated material
- Biological protection tested to EN 14126
- 2-way zipper with fully sealable storm flap for added on-off convenience and extra protection
- 3-panel hood design for enhanced compatibility with complimentary PPE
- Knitted cuffs and elasticated waist and ankles for increased comfort and freedom of movement
- Anti-static treatment to EN 1149 to reduce charge build up
- Super low-linting
- Supplied in space saving vacuum packaging
- Meets inward leakage requirements of EN 1073-2 for protection against nuclear particles

CE Type 4:

Testing to Type 4 standards requires the coverall material to be put through additional testing. A whole body suit test is conducted with a higher volume of liquid than the equivalent Type 6 test. More importantly, the material and the seams have permeation tests conducted with a minimum of one chemical to assess whether the chemical/s can get through the material at a molecular level. The construction of the laminate used in the 3M protective coverall 4565 offers a superior performance in this area compared to many other Type 4 products.



3M™ Protective Coverall 4565 Type 4/5/6

Colour: White with red taped seams

CE Category III

Sizes: S-4XL



Fabric Material

20% lighter than previous 3M polyethylene laminate materials, the 3M protective coverall 4565 combines a composite base of nonwoven fibres and a polyethylene film giving good barrier efficiency against many hazardous liquids. The laminate is also ultra-low linting and anti-static treated making it suitable for a wide variety of potentially hazardous applications.

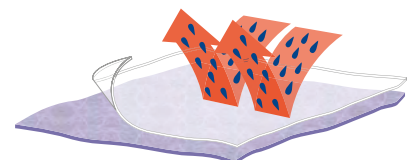

Seam Technology

Seams are stitched and overtaped with a red protective tape to offer increased seam strength and an effective barrier to liquids and particulates.

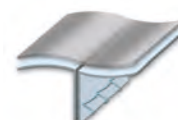

3M™ Protective Apparel

3M™ Protective Coverall 4570



The 3M™ Protective Coverall 4570 is a high performance chemical protective suit, certified to PPE Directive Category III, Type 3/4/5/6 levels of protection, making it suitable to protect against a range of chemical jets and sprays. With additional design features including an enlarged zip and finger loops, a double-closing storm flap system and chin flap, convenience of use can be offered without compromising the high level of protection given.

Typical Applications

Popular Choice

- Chemical mixing and handling
- Chemical/oil spills and clean up
- Metal Refining
- Metal Etching
- Hazardous waste remediation
- Decontamination/Site Decommissioning
- Tank cleaning
- Infective agents/Biological Hazards
- Handling Toxic Powders

Suitable for Consideration

- Light industrial cleaning
- Machine maintenance
- Pharmaceutical processing
- Handling toxic powders
- Resin applications

Features and Benefits:

- Excellent barrier for jet spray and liquid tight chemical protection (CE Type 3/4)
- Biological / infective agent protection (EN 14126) to the maximum class
- Seams are taped with a multi layer coextruded clear tape, giving a discreet finish and a consistent seal and barrier
- 3-panel hood design for enhanced compatibility with complimentary PPE
- Two stormflaps combined with double colour coded zips to create a double seal for added convenience and extra protection
- Larger easy grab ring pulls for ease of use
- Elasticated cuffs with thumb loops for secure fit during overhead work
- Elasticated waist and ankles for increased comfort and freedom of movement
- Glued in waist elastic and seam free shoulders to minimise entry points for confidence of wearer
- Adhesive chin flap
- Super low-linting
- Anti-static treatment to EN 1149 to reduce charge build up
- Meets inward leakage requirements of EN 1073-2 for protection against nuclear particles



3M™ Protective Coverall 4570 Type 3/4/5/6

Colour: Grey

CE Category III

Size: S-4XL



Fabric Material

The 3M protective coverall 4570 uses a heavy-duty material blending a soft inner layer of spun bond fibres with layers of a high performance anti-static treated polyethylene laminate, to offer a high level of liquid protection.

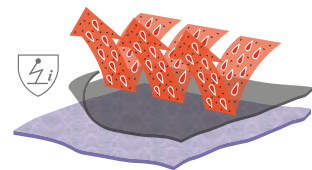

Seam Technology

Seams are stitched and overtaped with a clear heat applied multi-layer chemically protective tape to offer increased strength and an effective barrier to liquids and particulates.

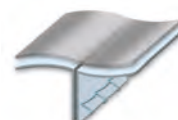

For technical information and chemical permeation data, please request a Technical Datasheet.

3M™ Protective Apparel

Accessories

From head to toe, we've got you covered with a full range of add-on options to give your workers the body protection they need.

Coats

3M™ Lab Coat 4440

- Made of the same laminated material as the Type 5/6 3M Protective Coverall 4535
- Anti-static treated
- Knitted cuffs
- Zip fastener
- Available in white



3M™ Visitor Coat 4400

- Made of the same material as the 3M Coverall 4500
- 100% soft, breathable and lightweight polypropylene
- Zip fastener
- Internal pocket
- Available in white



Overboots

3M™ Overboot 450



Slip Resistant Sole

- Elastic at the calf
- 3M Overboot 440 16inch length with ties for good fit
- 3M Overboot is available in standard 16inch or 11.5inch length, both models with ties
- Made of the same laminated material as the Type 5/6 3M™ Protective Coverall 4535
- 3M Overboot 450 has a PVC sole to help reduce the risk of slipping
- Laminated material ties to minimise particle shed and contamination in particle restricted environments such as cleanrooms

3M™ Overboot 440



Standard Sole

Overshoes

3M™ Overshoe 442



- Made of the same laminated material used in the Type 5/6 3M™ Protective Coverall 4535
- Elastic at ankle
- Anti-static treated

3M™ Overshoe 402



- General non-hazardous substance protection
- Sole has printed pattern to help reduce the risk of slipping
- Elastic at ankle

Oversleeves

3M™ Oversleeve 444



- Made of the same laminated material as the Type 5/6 3M Protective Coverall 4510
- 16 inch length covering wrist to top of arm
- Elastic finish on top end for secure fit
- Anti-static treated

Head Wear

3M™ Overhood 446



- Made of the same microporous laminated material as the Type 5/6 3M™ Protective Coverall 4510
- Anti-static treated
- Drapes over the shoulders offering excellent coverage

3M™ Protective Apparel

Product selector diagram*

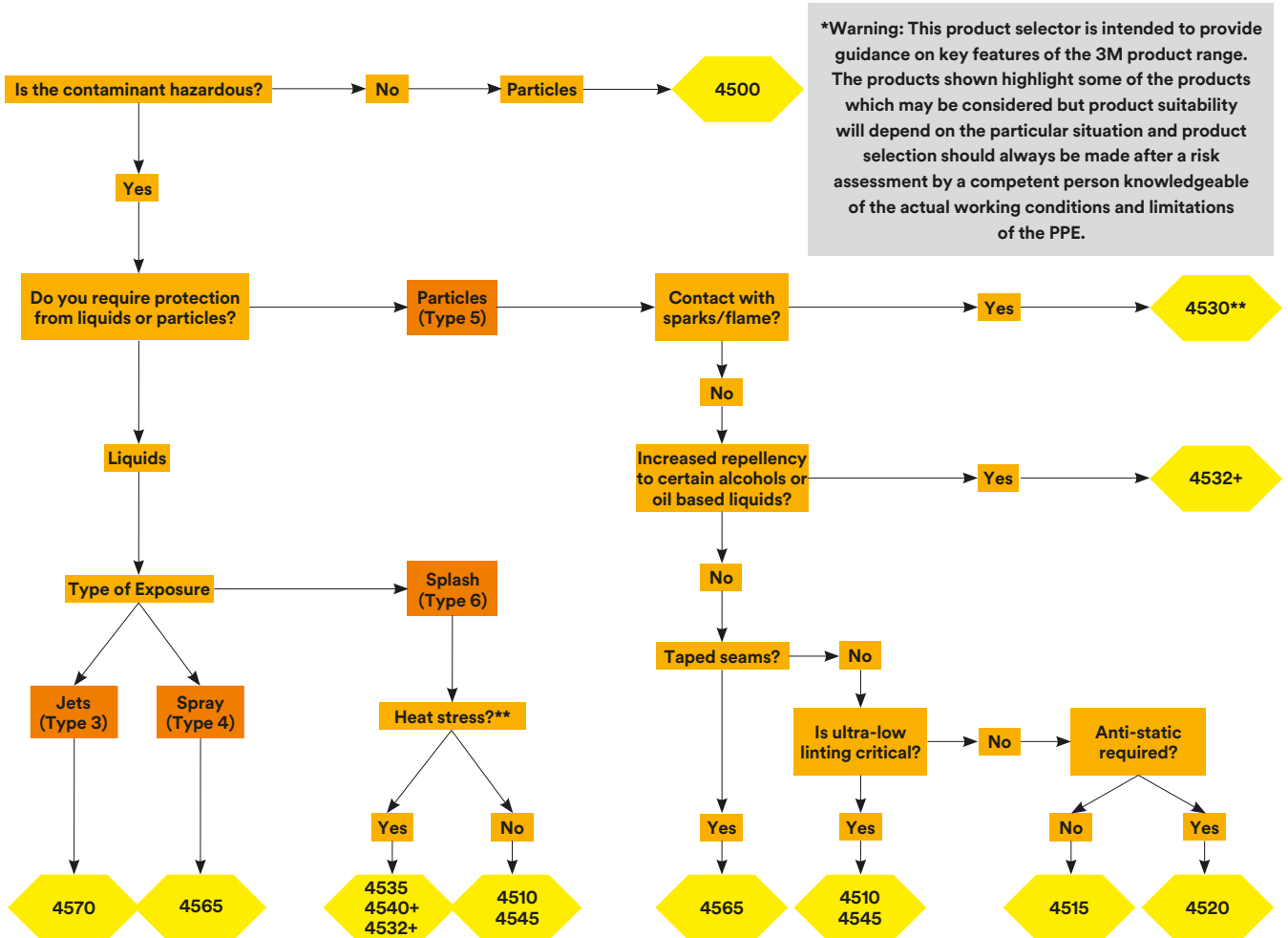

**Not suitable for flame protection, to be used in conjunction with an Index 2/3 garment only

*** For more information on the breathability of the 3M protective coveralls line, see the technical bulletin on breathability and our coveralls RET performance

3M™ Protective Coveralls Protection Types

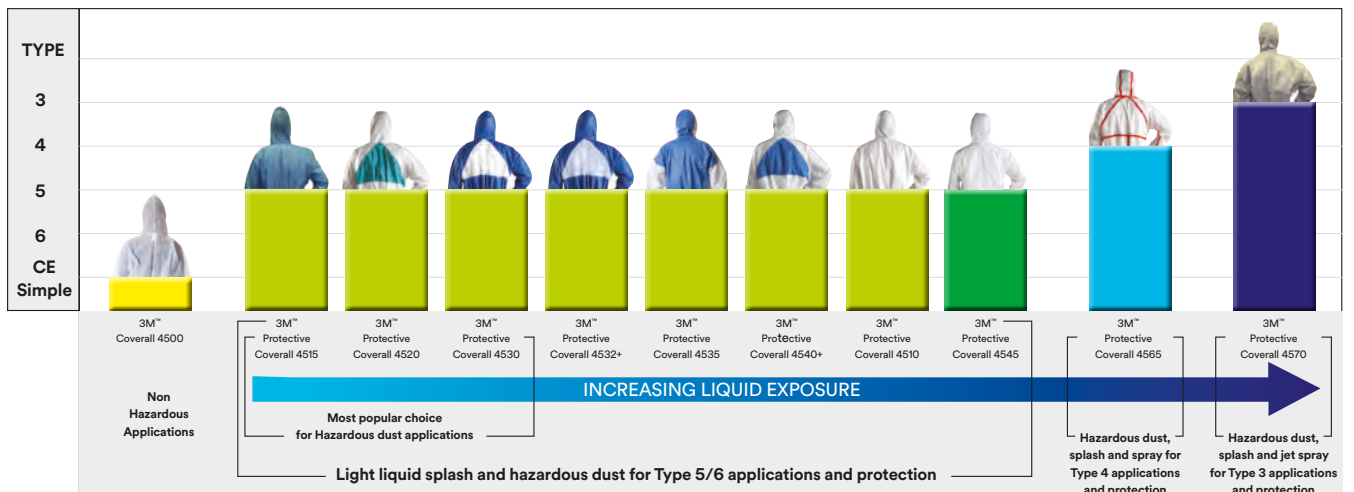

This guide is only an outline. It should not be used as the only means for selecting protective clothing. Always read and follow all user instructions supplied with your 3M™ Protective Coveralls in order to ensure correct operation. Final determination as to the suitability of these products for a particular situation is the employers responsibility. If in doubt contact a safety professional. For further information on the performance data of these garments or for any other questions contact your local 3M representative. LIMITATION OF LIABILITY: Except as provided above, 3M shall not be liable or responsible for any loss or damage, whether direct, indirect, incidental, special or consequential arising out of the sale, use or misuse of 3M PSD products, or the user's inability to use such products.

3M™ Protective Apparel

Product selector table*

Visit 3M Chemical Test library at <http://go.3M.com/CHTL> to review the chemical protective properties of the fabrics used in our range and see which 3M™ Protective Apparel solution could best meet your needs.



	3M	4500	4510	4515	4520	4530	4532+	4535	4540+	4545	4565	4570
	Category 1	Category 3	Category 3	Category 3	Category 3	Category 3	Category 3	Category 3	Category 3	Category 3	Category 3	Category 3
CE Certification**												
Material Weight (laminate)	45gsm	55gsm	50gsm	43gsm	54gsm	52gsm	55gsm		55gsm	55gsm		92gsm
Material Weight (back panel)							43gsm	43gsm				
Size	S-4XL	S-4XL	S-4XL	S-4XL	S-4XL	S-4XL	S-3XL	S-4XL	S-4XL	S-4XL	S-4XL	S-4XL
Colours												
Light-duty cleaning, warehousing, janitorial	●		●									
Asbestos inspection, site preparation, insulation		●	●	●	●	●	●	●	●	●	●	
Asbestos removal		●	●	●	●	●	●	●	●	●	●	●
Cement manufacturing, metal grinding & polishing		●	●	●	●	●	●	●	●	●	●	●
Light industrial cleaning, machine maintenance		●	●	●	●	●	●	●	●	●	●	●
Pharmaceutical processing, handling toxic powders		●		●	●	●	●	●	●	●	●	●
Painting & coating, resins		●				●	●	●	●	●	●	●
Cleanrooms		●							●	●	●	
Pesticide spraying											●	●
Chemical mixing and handling											●	●
Chemical spills, emergency response, decontamination, tank cleaning												●

● Popular choice ● Suitable for consideration

* In all cases, product selection should be based on a full risk assessment. Always read product user information. Use limitations and performance data should be considered to ascertain the protection required. If in doubt, contact a safety professional. This guide is only an outline. It should not be used as the only means for selecting protective clothing. Details regarding performance and limitations are set out on the packaging and user instructions. Before using any protective clothing, the wearer must read and understand the user instructions for each product. Specific country legislation must be observed. If in doubt, contact a safety professional or 3M – www.3M.eu/safety. Always check the compatibility of the suit material before selection. Please note that the personal protective equipment (PPE) shown highlight some of the products which may be considered. Sections of the most appropriate PPE will depend on the particular situation and should be made only by a competent person knowledgeable of the actual working conditions and the limitations of PPE.

** See user instructions or technical datasheets for full details.

***Material meets standard requirements.



3M™ Scotchlite™ Reflective Materials

3M™ Scotchlite™ Reflective Material has proven to be an excellent choice when it comes to incorporating retroreflective materials into occupational and protective garments.

We have been enhancing the visibility of road workers and making them safer in all types of traffic situations for almost 80 years.

Do not compromise. Trust the original.

3M™ Scotchlite™ Reflective Materials

How retroreflection works

3M™ Scotchlite™ Reflective Material technology has never been more state of the art than it is now.

Thousands of small glass beads reflect incidental light, tightly bundled, back to the original light source. The glass beads provide 100% surface reflection, making it the most efficient way of reflecting light.

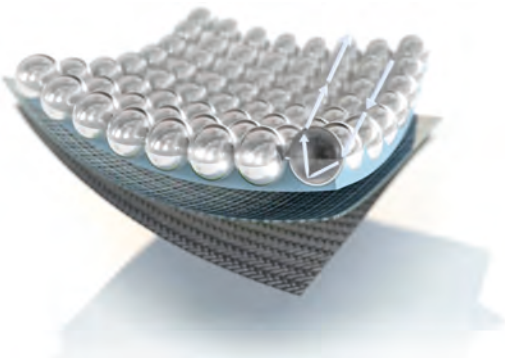

3M™ Scotchlite™ Reflective Material Series 9945

For the ultimate protection in the harshest conditions

Features and Benefits:

This product is certified to all required standards for multinorm garments and comes with a next-level industrial wash performance (including disinfectant). Its performance level remains unchanged for the full lifetime of the garment, wash after wash, giving its wearers the ultimate protection at all times.

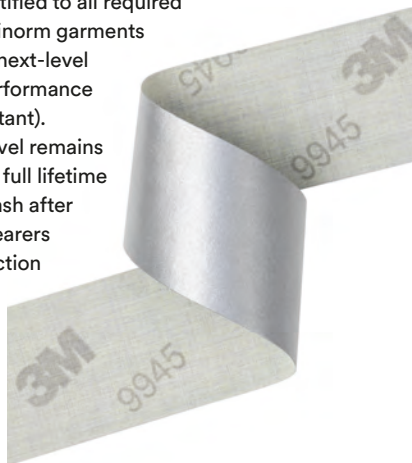

It offers:

- Flame resistance
- Sewed on design
- Reliable performance in harsh washing conditions
- OEKO-TEX standard 100 certified

3M™ Scotchlite™ Reflective Material 5696/5697

Ideal for use in firefighting apparel and flame-resistant workwear

Features and Benefits:

- Combines daytime and night-time visibility in one product
- Especially flexible and lightweight
- Segmented to make it easier for moisture to escape

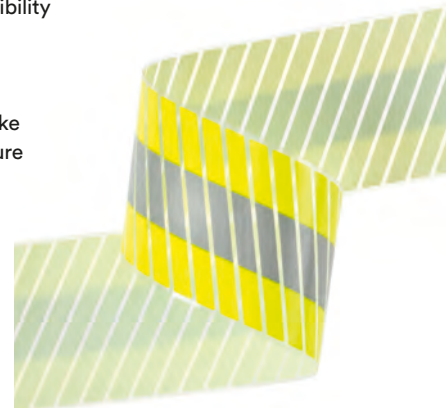

3M™ Scotchlite™ Reflective Materials

Our focus markets



High-visibility protection

Wearers of high-visibility garments are usually found in critical traffic situations where it is important to be seen early by other road users. High-visibility clothing signals that there are people in a dangerous area. A high degree of day and night conspicuity is therefore required. Fluorescent colours and 3M™ Scotchlite™ Reflective Material on clothing ensure that no one is overlooked in such critical situations.

High-visibility clothing needs to be robust and durable, and, of course, suitable for industrial washing, depending on the specific application. 3M™ Scotchlite™ Reflective Material provides long lasting functionality even under harsh conditions. 3M™ Scotchlite™ Reflective Material has been the first choice for high-visibility clothing for many years.



Industry

Different markets have completely different requirement profiles. That's why each industrial target group requires a bespoke solution. But one thing is clear: anyone working in production or warehouse facilities should be sufficiently visible.

Your individual requirement profile will determine which properties of 3M™ Scotchlite™ Reflective Material you want to use for your industrial clothing. In addition to its well-known products, 3M also produces a range of flame-resistant reflective materials.



Firefighting

When it comes to firefighting garments, only flame-resistant products with high durability can be used.

The yellow/silver/yellow triple trim developed by 3M is synonymous with the firefighting industry. Only the original – 3M™ Scotchlite™ Reflective Material 9687 – stands for the highest quality and best properties. It has been specially designed for use in fire protective clothing and flame-resistant workwear. It is especially robust and durable, guaranteeing maximum visibility, day or night.



Rescue Services

People working in rescue services frequently encounter confusing situations. It is therefore all the more important for these “rescuers” to be seen early, especially during twilight and at night. Retroreflective materials on their uniforms are standard; this is where high quality and durability count.

The new 3M™ Scotchlite™ Reflective Material 9925 has been developed especially for the use on rescue service apparel. It offers excellent washing performance, even after 50 cycles of disinfected wash.

3M™ Scotchlite™ Reflective Materials

Body Language

Making people immediately visible has been shown to increase a vehicle driver's attention significantly. To achieve this, the reflective stripes on a garment are arranged in such

a way that the silhouette of the human body is recreated by reflected light. 3M's Body Language concept is the basis for many different applications of retroreflective materials.



360 Degrees

The interplay of design, high functionality and good visibility of the wearer are crucial for selecting Corporate Identity workwear. We would be happy to help you to implement and perfectly integrate higher visibility into your design.

And that's not all – we go one step further and evaluate your range from all angles. All measurements are documented and displayed graphically in a spider diagram. This allows the "dark" spots in your clothing to be perfectly analyzed and avoided.

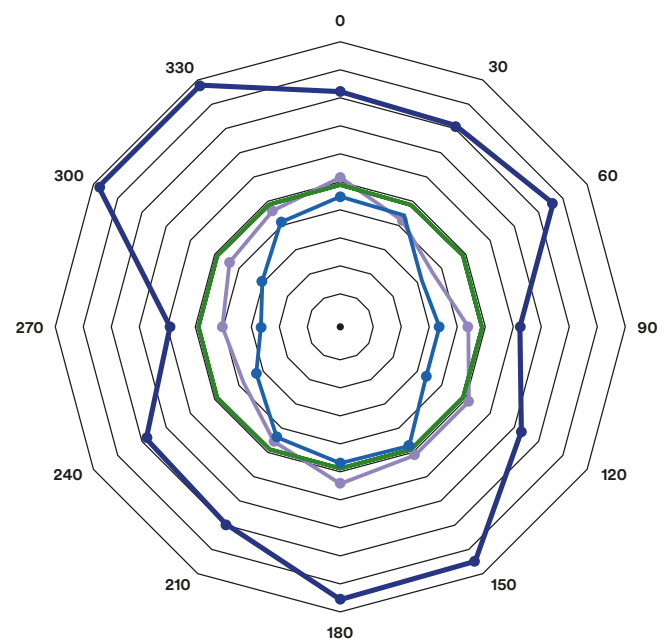
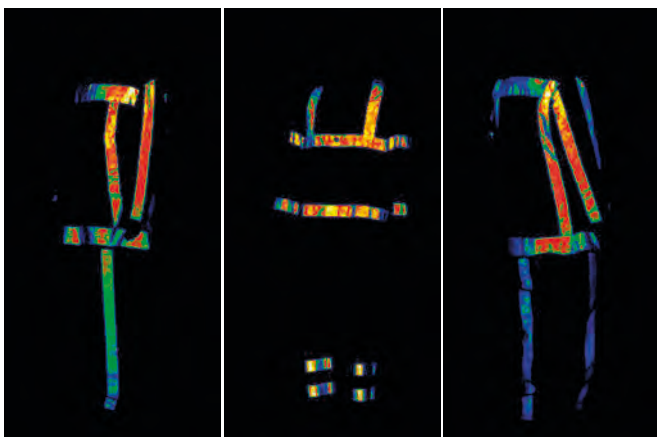

3M™ Scotchlite™ Reflective Materials

3M™ Scotchlite™ Reflective Material Product Selector

	Product	Flame resistant	Home wash	Dry cleaning	Industrial wash	Disinfectant industrial wash	Tunnel finisher	Tumbler	OEKO-TEX
Fabrics	8906	-	30 x 60 °C	-	-	-	-	-	YES
	8910	-	50 x 60 °C	30 x	-	-	-	-	-
	8912	-	60 x 60 °C	-	-	-	-	-	YES
	8925	-	75 x 60 °C	50 x	-	-	-	-	YES
	8932	YES	50 x 60 °C	15 x	-	-	-	-	-
	8935	YES	50 x 60 °C	30 x	-	-	-	-	-
	8940	YES	50 x 60 °C	30 x	50 x 75 °C	-	YES	YES	-
	9910	-	100 x 60 °C	50 x	30 x 75 °C	5 x 75 °C	-	YES	YES
	9920	-	50 x 60 °C	30 x	40 x 75 °C	-	YES	-	YES
	9925	-	100 x 60 °C	50 x	75 x 75 °C	50 x 75 °C	YES	YES	YES
9945	YES	100 x 60 °C	50 x	100 x 75 °C	50 x 75 °C	YES	YES	YES	
Transfer films	C790	-	50 x 40 °C	-	-	-	-	-	YES
	5807	-	50 x 60 °C	30 x	-	-	-	-	YES
	8711	-	25 x 60 °C	25 x	-	-	-	-	YES
	8712	-	25 x 60 °C	25 x	-	-	-	-	YES
	8725	-	50 x 60 °C	30 x	-	-	-	-	YES
	8726	-	50 x 60 °C	30 x	-	-	-	-	-
	8735	YES	50 x 60 °C	-	15 x 75 °C	-	YES	YES	-
	8787	-	-	-	-	-	-	-	-
	9720	-	50 x 60 °C	50 x	25 x 75 °C	-	YES	YES	YES
Comfort trims	5410	-	75 x 60 °C	30 x	-	-	-	-	YES
	5510	-	75 x 60 °C	30x	-	-	-	-	YES
	5530	-	50 x 60 °C	-	15 x 75 °C	-	YES	-	YES
	5535	YES	65 x 60 °C	-	15 x 75 °C	-	YES	YES	-
Fire market products	8986/8987	YES	-	-	-	-	-	-	-
	9686/9687	YES	50 x 60 °C	30 x	-	-	-	-	-
	5636/5637	YES	30 x 60 °C	-	-	-	-	-	-
	5696/5697	YES	50 x 60 °C	-	-	-	-	-	-

3M™ Scotchlite™ Reflective Materials

3M™ Scotchlite™ Reflective Material fabrics

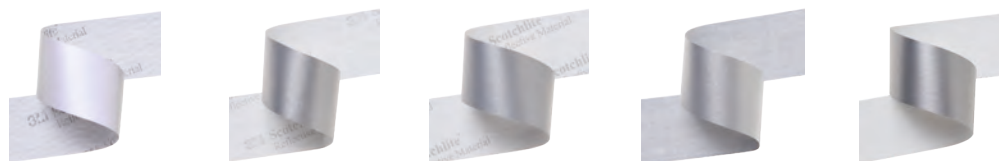

Features	8906	8910	8912	8925	8932
Daytime colour	silver	silver	silver	silver	silver
Backing	65 % polyester 35 % cotton	65 % polyester 35 % cotton	65 % polyester 35 % cotton	65 % polyester 35 % cotton	100 % FR cotton
Flame resistant	–	–	–	–	YES
60 °C home wash ISO 6330-6N/F	30 x	50 x	60 x	75 x	50 x
Dry cleaning ISO 3175-2	–	30 x	–	50 x	15 x
75 °C industrial wash ISO 15797-8	–	–	–	–	–
75 °C disinfectant industrial wash ISO 15797-2	–	–	–	–	–
Tunnel finisher ISO 15797	–	–	–	–	–
Tumbler ISO 15797	–	–	–	–	–
OEKO-TEX	YES	YES	YES	YES	–
European certifications	ISO 20471	ISO 20471	ISO 20471	ISO 20471	ISO 20471 EN 469 ISO 11611 ISO 11612 ISO 14116

3M™ Scotchlite™ Reflective Material transfer films



Features	C790	5807	8711	8712
Daytime colour	black	silver	silver	silver
Backing	100 % polymer	100 % polymer	100 % polymer	100 % polymer
Flame resistant	–	–	–	–
60 °C home wash ISO 6330-6N/F	50 x (40 °C)	50 x	25 x	25 x
Dry cleaning ISO 3175-2	–	30 x	25 x	25 x
75 °C industrial wash ISO 15797-8	–	–	–	–
75 °C disinfectant industrial wash ISO 15797-2	–	–	–	–
Tunnel finisher ISO 15797	–	–	–	–
Tumbler ISO 15797	–	–	–	–
OEKO-TEX	YES	YES	YES	YES
European certifications	–	ISO 20471	ISO 20471	ISO 20471

3M™ Scotchlite™ Reflective Materials

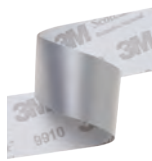
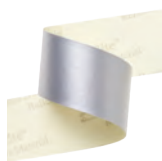
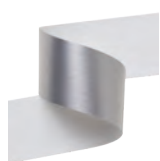

8935	8940	9910	9920	9925	9945
silver	silver	silver	silver	silver	silver
100 % FR cotton	100 % aramid	100 % polyester	100 % polyester	100 % polyester	100 % aramid
YES	YES	–	–	–	YES
50 x	50 x	100 x	50 x	100 x	100 x
30 x	30 x	50 x	30 x	50 x	50 x
–	50 x	30x	40 x	75 x	50 x
–	–	5 x	–	50 x	50 x
–	YES	–	YES	YES	YES
–	YES	YES	–	YES	YES
–	–	YES	YES	YES	YES
ISO 20471 EN 469 ISO 11611 ISO 11612 ISO 14116	ISO 20471 EN 469 ISO 11611 ISO 11612 ISO 14116	ISO 20471	ISO 20471	ISO 20471	ISO 20471 EN 469 ISO 14116 ISO 11611 ISO 11612

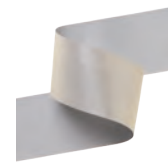
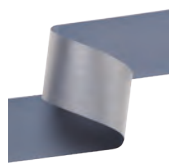

8725	8726	8735	8787	9720
silver	silver	silver	lime yellow	silver
100 % polymer	100 % polymer	100 % FR polymer	100 % polymer	100 % polymer
–	–	YES	–	–
50 x	50 x	50 x	–	50 x
30 x	30 x	–	–	50 x
–	–	15 x	–	25 x
–	–	–	–	–
–	–	YES	–	YES
–	–	YES	–	YES
YES	YES	–	–	YES
ISO 20471	ISO 20471	ISO 20471 EN 469 ISO 11611 ISO 11612 ISO 14116	ISO 20471	ISO 20471

3M™ Scotchlite™ Reflective Materials

3M™ Scotchlite™ Reflective Material comfort trims

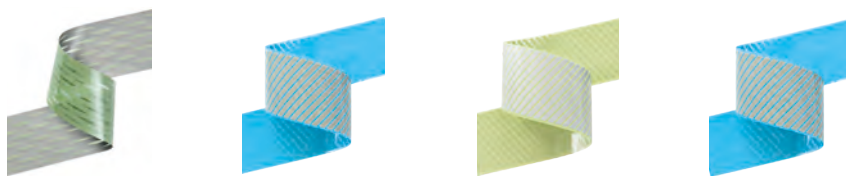

Features	5410	5510	5530	5535
Daytime colour	silver	silver	silver	silver
Backing	100 % polymer	100 % polymer	100 % polymer	100 % FR polymer
Flame resistant	–	–	–	YES
60 °C home wash ISO 6330-6N/F	75 x	75 x	50 x	65 x
Dry cleaning ISO 3175-2	30 x	30 x	–	–
75 °C industrial wash ISO 15797-8	–	–	15 x	15 x
75 °C disinfectant industrial wash ISO 15797-2	–	–	–	–
Tunnel finisher ISO 15797	–	–	YES	YES
Tumbler ISO 15797	–	–	–	YES
OEKO-TEX	YES	YES	YES	–
European certifications	ISO 20471	ISO 20471	ISO 20471	ISO 20471 EN 469 ISO 11611 ISO 11612 ISO 14116

3M™ Scotchlite™ Reflective Material fire market products



Features	8986/8987	9686/9687	5636/5637	5696/5697
Daytime colour	red orange/ lime yellow	orange-silver-orange/ yellow-silver-yellow	orange-silver-orange/ yellow-silver-yellow	orange-silver-orange/ yellow-silver-yellow
Backing	100 % FR cotton	100 % aramid	100 % FR polymer	100 % FR polymer
Flame resistant	YES	YES	YES	YES
60 °C home wash ISO 6330-6N/F	–	50 x	30 x	50 x
Dry cleaning ISO 3175-2	–	30 x	–	–
75 °C industrial wash ISO 15797-8	–	–	–	–
75 °C disinfectant industrial wash ISO 15797-2	–	–	–	–
Tunnel finisher ISO 15797	–	–	–	–
Tumbler ISO 15797	–	–	–	–
OEKO-TEX	–	–	–	–
European certifications	ISO 20471 EN 469 ISO 11611 ISO 11612 ISO 14116	ISO 20471 EN 469 ISO 11611 ISO 11612 ISO 14116	ISO 20471 EN 469 EN 15614 ISO 11611 ISO 11612 ISO 14116	ISO 20471 EN 469 ISO 11611 ISO 11612 ISO 14116



3M™ Fall Protection

3M Fall Protection, part of the 3M Personal Safety Division offers first-to-market innovations and high-performance solutions that have earned us a reputation as experts in fall protection, safe working in confined spaces and rescue.

We're better equipped than ever to continue investing in technology and products that enhance worker safety, productivity and comfort through our DBI-SALA® and Protecta® brands.

We're elevating safety and comfort to new heights.

3M™ Fall Protection



Certification icons



Belts and restraint lanyards for work positioning



Full body harness



Rescue harnesses

The European Commission has published a certain number of standards intended to control the design and use of rescue and personal protection equipment against falls from height. These standards must be adhered to, and are applicable in all the member states.

Harness icons



Chest



Leg



Shoulders



Waist



180° Positioning Belt



CE Certification



Adjustable Chest



Adjustable Leg



Adjustable Shoulder



Adjustable Waist



Adjustable Waist with Back Pad



Dorsal D-Ring



Sternal D-Ring



Work Positioning



Pectoral D-Ring



Rescue Attachment Point



Suspension Attachment Point



Fall Indicator



Carrying Pocket



Rigid Hip Padding Loops



Rigid Shoulder Caps



Front Loops



Duo-Lok™ Quick Connect Buckle



Pass Through Buckle



Quick Connect Buckle



Tongue & Grommet Buckle



Comfort Padding



TechLite™



3M™ Fall Protection

3M™ DBI-SALA® ExoFit NEX™ Harness

The ExoFit NEX harness gives workers the freedom and confidence to function to their maximum. Innovative safety devices and design features allow workers to work smart, fast and safe increasing productivity. Designed using soft yet extremely durable anti-absorbent, abrasion resistant webbing of lasting strength, harnesses can withstand the most severe demands, day in, day out. They are built to perform to the highest standards in the harshest environments. 140 kg capacity.

Features and Benefits:



Moulded Lanyard Keepers

- Easy holstered snap hooks
- Breakaway to avoid trip hazard.



Covered Labels

- A hook and loop cover protects harness labels.



3M™ DBI-SALA® Duo-Lok™ Quick Connect Buckles

- Lightweight one-handed use with memory-fit web-lock ensures fast, non-slipping connections.



Vertical Torso Adjusters

- Simple and fast adjustments that eliminate loose ends and lock into place, preventing slippage.



3M™ DBI-SALA® Repel™ Technology Webbing

- Abrasion resistant and water repellent to reduce attraction of mould and dirt.



Integrated Suspension Relief Straps

- Provide an adjustable, continuous loop for post fall, offering suspension relief.



Stand Up Dorsal D-ring

- Spring-loaded design automatically stands-up, ensuring fast, easy and safe connections to your fall arrest system.



Built-in Impact Indicators

- Rip-stitch indicators allow you to inspect the harness for prior damaging impact loads.

Weight Capacity

- 140 kg.



3M™ Fall Protection

3M™ DBI-SALA® ExoFit NEX™ Harness



Best Seller
1113902



	↔	DL	DL	kg
1113900	S	DL	DL	1.86
1113901	M	DL	DL	1.91
1113902	L	DL	DL	1.95
1113903	XL	DL	DL	2.00

3M™ DBI-SALA® ExoFit NEX™ Harness with Belt



	↔	DL	DL	DL	kg
1113910	S	DL	DL	DL	2.75
1113911	M	DL	DL	DL	2.81
1113912	L	DL	DL	DL	2.86
1113913	XL	DL	DL	DL	2.92

ExoFit NEX Wind Energy Harness with Belt



	↔	DL	DL	DL	kg
1113925	S	DL	DL	DL	3.00
1113926	M	DL	DL	DL	3.05
1113927	L	DL	DL	DL	3.10

3M™ DBI-SALA® ExoFit NEX™ Suspension Harness



Best Seller
1113962

	↔	DL	DL	kg
1113960	S	DL	DL	2.20
1113961	M	DL	DL	2.30
1113962	L	DL	DL	2.40
1113963	XL	DL	DL	2.50

3M™ Fall Protection

3M™ DBI-SALA® Delta™ Comfort Harness

The Delta Comfort full-body harness offers innovative features such as an improved ergonomic fit and feel, lighter-weight buckles and high-strength webbing. Employing a patented No-Tangle triangle pattern that creates a frame allowing the harness to easily fall into place when donned.

The Delta Comfort harness features liquid-resistant 3M™ DBI-SALA® Delta™ Repel™ Technology Webbing and 3M™ DBI-SALA® Revolver™ Torso Adjusters, which allow for quick adjustment and eradicates loose strap ends.

Features and Benefits:



3M™ DBI-SALA® Repel™ Technology Webbing

- Abrasion resistant and water repellent to reduce attraction of mould and dirt.



Lanyard Keepers

- Avoids carrying lanyard by hand when not in use.



Comfort Padding

- To the underside of the shoulder straps, hips and legs.



3M™ DBI-SALA® Revolver™ Torso Adjusters

- Simple and fast adjustment that eliminates loose ends and locks into place preventing slippage.



3M™ DBI-SALA® Tech-Lite™ Quick Connect Buckles

- Lightweight aluminium alloy buckles for fast and easy connections. Other connections available (Pass Through models also available).



Stand Up Dorsal D-ring

- Stands-up dorsal D-ring, ensures fast, easy and safe connections to your fall arrest system.



Rigid Belt

- Allows for 27 kg of tools without collapsing.



Protected Labels

- A hook and loop cover protects harness labels.

Weight Capacity

- 140 kg.



Built-in Impact Indicators

- Rip-stitch indicators allow you to inspect the harness for prior damaging impact loads.



3M™ Fall Protection

3M™ DBI-SALA® Delta™ Comfort Harness with Belt



	←.....→				
1112962	S	PT	PT	PT	2.35
1112961	U	PT	PT	PT	2.40
1112963	XL	PT	PT	PT	2.45

3M™ DBI-SALA® Delta™ Comfort Harness with Quick Connect Buckles



	←.....→			
1112953	S	QC	QC	1.70
1112952	U	QC	QC	1.75
1112954	XL	QC	QC	1.85

3M™ DBI-SALA® Delta™ Comfort Harness with Belt & Quick Connect Buckles



	←.....→				
1112965	S	QC	QC	QC	2.55
1112964	U	QC	QC	QC	2.60
1112966	XL	QC	QC	QC	2.70

3M™ DBI-SALA® Delta™ Comfort Harness



	←.....→			
1112947	S	PT	PT	1.50
1112946	U	PT	PT	1.55
1112948	XL	PT	PT	1.65

3M™ Fall Protection

3M™ DBI-SALA® Delta™ Harness

Innovative body support for more than two decades. Toughness. Versatility. These are qualities expected of you, so you should expect nothing less from your safety harness. Delta harnesses combine a number of innovations with popular features that have made an industry workhorse that's as tough as those who wear them. Delta harnesses have a shape of their own, so you can don them quickly and easily.

Features and Benefits:



3M™ DBI-SALA® Delta™ Repel™ Technology Webbing

- Abrasion resistant and water repellent to reduce attraction of mould and dirt.



Lanyard Keepers

- Avoids carrying lanyard by hand when not in use.



Revolver™ Vertical Torso Adjusters

- Simple and fast adjustments that eliminate loose ends and lock into place, preventing slippage.



Built-in Impact Indicators

- Rip-stitch indicators allow you to inspect the harness for prior damaging impact loads.



Covered Labels

- A hook and loop cover protects harness labels.

•



Stand Up Dorsal D-ring

- Spring-loaded design automatically stands-up, ensuring fast, easy and safe connections to your fall arrest system.



3M™ DBI-SALA® No-Tangle™ Design

- Defining the Delta name, the patented triangular design creates a frame that allows the harness to fall into place when donned.



3M™ DBI-SALA® Surefit™

No-Tangle Design

- Ensures correct fitting of the harness in the event of a fall while still providing additional comfort for everyday use.

Weight Capacity

- 140 kg.

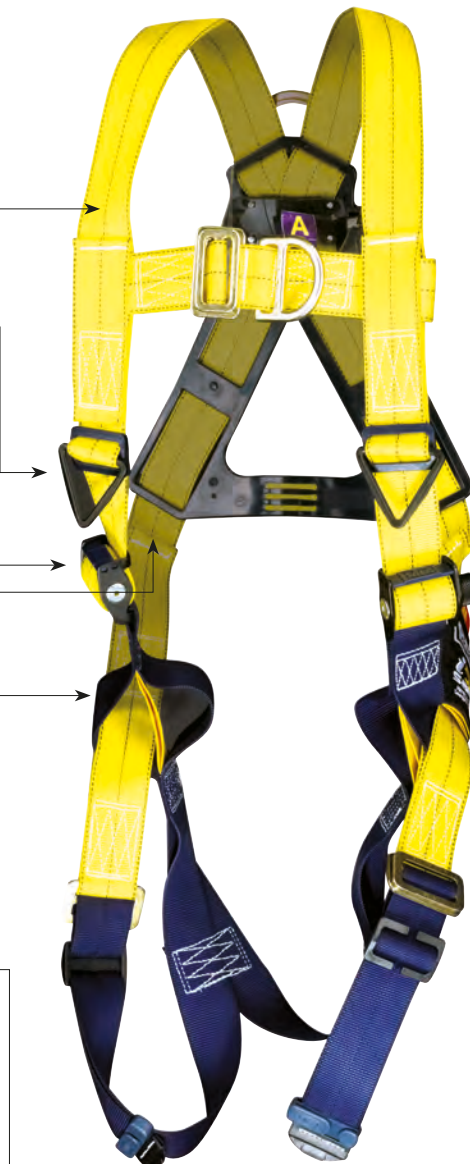

3M™ Fall Protection

3M™ DBI-SALA® Delta™ Harness



	↔			
1112901	S	PT	PT	1.50
1112900	U	PT	PT	1.55
1112902	XL	PT	PT	1.65

3M™ DBI-SALA® Delta™ Harness with Quick Connect Buckles



Best Seller
1112912



	↔			
1112913	S	QC	QC	1.70
1112912	U	QC	QC	1.75
1112914	XL	QC	QC	1.85

3M™ DBI-SALA® Delta™ Harness with Belt



	↔				
1112907	S	PT	PT	PT	2.35
1112906	U	PT	PT	PT	2.40
1112908	XL	PT	PT	PT	2.50

3M™ DBI-SALA® Delta™ Harness with Belt & Quick Connect Buckles



	↔				
1112910	S	QC	QC	QC	2.55
1112909	U	QC	QC	QC	2.60
1112911	XL	QC	QC	QC	2.70

3M™ Fall Protection

3M™ Protecta® Fall Arrest Harness

Introducing the new generation of 3M™ Protecta® Fall Arrest Harnesses.

3M Protecta Fall Arrest Harnesses provide reliable protection, comfort and convenience; now with upgraded features and a sleek, modern look.

Available in a variety of styles and configurations, these new harnesses have enhanced features including water and stain resistant webbing, auto-resetting lanyard keepers as well as softer and more durable hip padding.

All models

- New** 1. Conveniently placed front fall arrest D-ring helps you stay balanced and centred*
- New** 2. Auto-resetting lanyard keeper provides easy parking and release of snap hooks or carabiners*
- New** 3. Easy and clear identification of fall arrest anchorage points
- New** 4. Hook and loop web ends – no loose web ends help you stay comfortable and tangle-free



- New** 5. Stain and water resistant webbing keeps the harness cleaner and dryer
- New** 6. Impact indicators make it simple to inspect the harness for damage and help ensure it's safe to use**
- New** 7. Modern black components – zinc plated steel with electro deposit paint finish
- New** 8. Protected labels for long-term identification and inspection

* Applicable models with front fall arrest D-ring only
**Excludes model 1161600, 1161601 & 1161602

Comfort belt style harness



New

1. Softer and more robust hip pad is 3x thicker* for extra comfort

New

2. Durable and sturdy belt for tool bag carrying convenience

* Compared to previous model



Standard vest style with horizontal legs

New

1. Articulated rings on horizontal leg straps allow upper and lower body to twist providing greater freedom of movement



Comfort belt style with horizontal legs

New

1. Articulated rings on horizontal leg straps allow upper and lower body to twist providing greater freedom of movement

New

2. Rotating belt enables movement within the harness while working in restraint/positioning

New

3. Gear tool loops* – tools can be secured while working at heights, to keep people and property safe anywhere below you

*Gear tool loops offered as standard on models 1161645, 1161646 & 1161647. Gear tool loops (accessory 1150492) can be retro-fitted on all other belted models



Comfort Leg Padding as standard on models 111645_46_47. For other models the accessory 1150494 is available and can be retro-fitted



3M™ Fall Protection



Best Seller
1161610

3M™ Protecta® Standard Vest Style Fall Arrest Harness

► 1 x Lanyard keeper



	↔	🔒	🌀	📊
1112913	S	PT	PT	1.11
1112912	M/L	PT	PT	1.16
1112914	XL	PT	PT	1.21



Best Seller
1161628

3M™ Protecta® Comfort Belt Style Fall Arrest Harness

► 1 x Lanyard keeper



	↔	🔒	🌀	🌀	📊
1161627	S	PT	PT	PT	1.85
1161628	M/L	PT	PT	PT	1.90
1161629	XL	PT	PT	PT	1.95



3M™ Protecta® Standard Vest Style Fall Arrest Harness with Horizontal Leg Straps

► 2 x Lanyard keepers



	↔	🔒	🌀	📊
1161642	S	QC	QC	1.57
1161643	M/L	QC	QC	1.62
1161644	XL	QC	QC	1.67



3M™ Protecta® Comfort Belt Style Fall Arrest Harness with Horizontal Leg Straps

► 2 x Lanyard keepers



	↔	🔒	🌀	🌀	📊
1161645	S	QC	QC	QC	2.41
1161646	M/L	QC	QC	QC	2.46
1161647	XL	QC	QC	QC	2.51

3M™ Fall Protection

3M™ Harnesses Accessories

3M™ DBI-SALA® Suspension Trauma Safety Straps

Suspension relief safety straps for full body harness.



9501403			kg
		0.14	

3M™ Protecta® Harness Extension Strap

Back D-ring extension strap 45 mm webbing. Screw gate triangle to attach to harness.



1150909			CE EN354	kg
	40 cm			0.20

3M™ Protecta® Nylon Transport Bag

Nylon transport bag.



AK043			kg
	500 × 300 mm		0.32

3M™ Protecta® Back Pack

3M Protecta branded rucksack to store and transport your fall arrest equipment.



9513331			kg
	15 × 30 × 50 cm		0.43

3M™ Fall Protection

3M™ Lanyards



Lanyard icons

General:



Dimension



Kilogrammes



Certification

Type:



Material Type



Material:
Aluminium



Material:
Steel

Lanyards:



Lanyard



Twin Leg



Tie-Back



Loops with
Thimbles



Carabiner



Screw Carabiner



Gate Strength
(Value)



Size of gate
opening



Twist Lock



Connector:
Lanyard End



Connector:
User End



Rope Type



Scaffold Hook



Snap Hook

3M™ Fall Protection

3M™ Lanyards

3M™ DBI-SALA® EZ-Stop™ Rope Shock Absorbing Lanyard

Compact and lightweight shock pack rated to 130 kg user weight. 10.5 mm dia. braided rope, lightweight aluminium twist-lock carabiners or scaffold hook connector options.



1245546	1.25 m	1		20 mm (A)		20 mm (A)			0.60
1245547	2.00 m	1		20 mm (A)		20 mm (A)			0.70
1245548	2.00 m	1		20 mm (A)		60 mm (A)			1.00
1245549	1.25 m	1		20 mm (A)		60 mm (A)			0.90
1245545	2.00 m	2		20 mm (A)		60 mm (A)			1.40

3M™ DBI-SALA® Work Positioning Rope Trigger Lanyard

The adjustment system allows the length of the lanyard to be easily adjusted during use. Protective cover on the rope.



1200313	Adj to 2 m	11 mm		21 mm (A)		21 mm (A)			0.74
1200311	Adj to 5 m	11 mm		21 mm (A)		21 mm (A)			0.92

3M™ DBI-SALA® Work Positioning Spreader Bar Lanyard

Confined space lanyard for use with rescue harness incorporating shoulder D-rings. Use for vertical lifts in confined space or rescue situations. Built in spreader bar keeps shoulder straps from being pulled in during use.



KF71201466	45 mm		19 mm (S)						1.30

3M™ DBI-SALA® EZ-Stop™ Expander Lanyard

- Elasticated webbing reduces length by up to 50 cm when not under tension.
- Reduced trip or snarling hazard.
- Leg material - 35 mm polyester webbing.



1245541	2 m		1			60 mm			1.00
1245534	2 m		2			60 mm			1.50

3M™ Fall Protection

3M™ DBI-SALA® EZ-Stop™ Edge Tested Lanyard

DBI-SALA®'s lanyards are designed to offer greater security to users exposed to falls over or around edges and tested rigorously over a 0.5mm radius edge. All edge tested products in the DBI-SALA range are differentiated from DBI-SALA standard shock absorbing lanyards and bear the Edge tested logo.

- The fall arrest solution for all users working at height exposed to falls around or over edges.
- 12 mm diameter rope offers extreme durability whilst maintaining flexible handling for ease of use. Orange accenting indicates suitability for edge applications.



Leg material	12 mm diameter kernmantle rope
Body Connector	AJ512/0, Aluminium Triple Lock, 22 mm opening size, 25 kN breaking strength or AJ567/0, Aluminium, 21 mm opening size, 22 kN breaking strength
Anchor Connectors	AJ527/0, Aluminium, 60 mm opening, 22 kN breaking strength or AJ512/0, Aluminium Triple Lock, 22 mm opening size, 25 kN breaking strength
Maximum User Weight	100 kg

	↔	🔗	👤	🔗	🔗	🔗	🔗	🔗	⚖️
1245555	1.5 m	■	2	🔗	21 mm	🔗	60 mm	1.50	
1245552	2 m		1	🔗	21 mm	🔗	60 mm	1.50	

3M™ DBI-SALA® EZ-Stop™ Webbing Lanyard

- General purpose fall arrest lanyards with polyester webbing leg material.
- Fixed lengths of 1.25 m & 2 m are available along with an adjustable model for applications where other lengths are required.



Leg Material	Web
Body Connector	Aluminium Twist Lock, 20 mm opening, 28 kN breaking strength
Anchor Connectors	AJ527/0, Aluminium, 60 mm opening, 22 kN breaking strength or Aluminium Twist Lock, 20 mm opening, 28 kN breaking strength

	↔	🔗	👤	🔗	🔗	🔗	⚖️
1245543	1.4 - 2 m		1	🔗	60 mm	1.10	
1245532	2 m	■	2	🔗	60 mm	1.10	
1245539	2 m		1	🔗	60 mm	1.30	

3M™ Fall Protection

3M™ Protecta® Rope Restraint Lanyard

Protecta rope connecting lanyards are an ideal solution for the connecting element in a restraint system. Made from polyamide braided rope with safety stitching. Rope diameter 10.50 mm.



									CE EN354
AL410B	1 m	1	-	-	-	-	-	-	0.11
AL410C	1 m	1							0.16
AL420C2	2 m	1		17 mm			50 mm		0.91
AL432/1	1.3 m	2		17 mm			50 mm		1.39

3M™ Protecta® Shock Absorbing Lanyards, 140 kg Capacity, Rope

Protecta® rope lanyard specifically designed for higher weight capacity of 140 kg. Strong, lightweight and available in a range of lengths, connection types and number of legs to suit your needs.



									CE EN358	
1260331	2 m	1	10.5 mm		50 mm			19 mm		0.8
1260332	1.8 m	2	10.5 mm		50 mm			17 mm		1.4
1260333	1.8 m	2	10.5 mm		50 mm			19 mm		1.4
1260334	Adj to 1.3 m -2 m	1	10.5 mm		17 mm			17 mm		0.8

3M™ Protecta® Work Positioning Lanyard - Trigger

The adjustment system allows the length of the lanyard to be easily adjusted during use.



									CE EN354
1200314	Adj to 2 m	10.5 mm		21 mm			24 mm		0.85
1200317	Adj to 3 m	10.5 mm		21 mm			24 mm		0.92
1200315	Adj to 4 m	10.5 mm		21 mm			24 mm		0.99

3M™ Protecta® Shock Absorbing Lanyards, 140 kg Capacity, Elasticated Webbing

Protecta® elasticated webbing lanyard specifically designed for higher weight capacity of 140 kg. Strong, lightweight and available in a range of lengths, connection types and number of legs to suit your needs.



									CE EN355
1260327	2 m	2		50 mm			18 mm		1.4
1260328	2 m	1		50 mm			18 mm		1.1
1260329	1.5 m	2		50 mm			18 mm		1.2
1260330	1.5 m	1		50 mm			18 mm		1.0

3M™ Fall Protection

3M™ Rope Grabs

3M™ Protecta® Viper™ Vertical Lifeline Rope Grab

- The Viper 2 rope grab is available in 2 variants, AC401 has the addition of a 28 cm extension strap with a self locking carabiner (9509437).
- It's extremely simple opening system means that the Viper 2 can be attached to the rope or removed from it at any location.
- As soon as the connecting carabiner is put back into place the Viper 2 is locked to ensure safe use.

The Viper 2 is supplied with a kernmantle rope and is available with rope options from 5 to 99 m lengths in increments of 5 m.

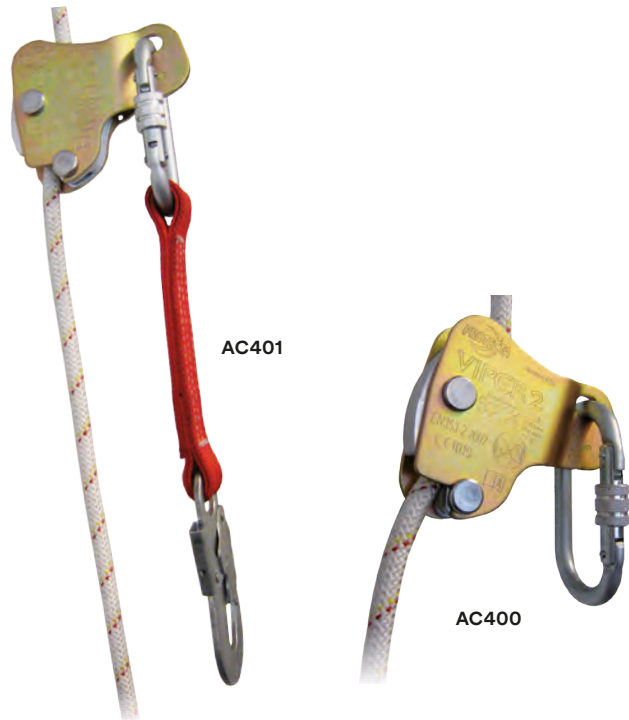

15 kN
CE
EN353-2

	⊙	∅	kg
AC400	AJ501	10.5 mm	0.44
AC401	9509437	10.5 mm	0.69

3M™ Protecta® Viper™ Vertical Lifeline Rope

Nylon static rope, ∅ 10.50 mm, with yellow and red wear indicator.
Rope end: sewn loop underneath protective sleeve Connector: AJ501, 17 mm opening System breaking strength > 22 kN.



CE
EN353
CE
EN353-2

	↔	kg
AC410	10 m	0.91
AC415	15 m	1.24
AC420	20 m	1.59
AC430	30 m	2.26

3M™ Protecta® Viper™ LT Rope Grab with Extension

Vertical fall arrest 100 kg user. Roof top work restraint use. A 175 mm extension strap with self-locking double action snap hook to aid ease of use when rope grab is attached to the harness.



CE
EN353-2

	kg
AC4001	0.56

Self-Retracting Lifelines



Self-Retracting Lifelines icons.



Housing



Double Action Swivel



Retrieval Winch



RSQ



Load Rating/ Capacity



Leading Edge



Self Locking Swivel Hook



Lifeline Material



Fall Indicator



Connector Material



Carabiner



Captive Eye



Rebar Hook



Scaffold Hook



Snap Hook



Swivelling Opening Hook



3M™ DBI-SALA® Saflok™ Carabiner



Webbing Width



Twin Leg

3M™ Fall Protection

3M™ DBI-SALA® Nano-Lok™ Web Self-Retracting Lifeline

Introducing the new 3M™ DBI-SALA® Nano-Lok™ Personal Self-Retracting Lifeline. Trusted for its reliability and durability, the Nano-Lok has been the industry's go-to personal SRL for many years. Our latest version not only matches the performance of the outgoing model, it surpasses it. It's sleeker with a more compact design. It's tougher with the longer-lasting cover. And it's easier to use and faster to connect. All whilst complying with CE EN 360:2002.

Features and Benefits:

Next generation features:

Saves time

- Installs 60% faster*
- Inspect easily and quickly

Built to last

- Nitrile rubber cover lasts 4X longer than outgoing model*

Tie-off versatility

- Foot-level tie off with 140 kg capacity

-

Fast connection system

Simple, light-weight connector allows backward compatibility

Compact housing

Built-in RFID tag

Sleek, durable nitrile rubber energy absorber
Length: 2 m**



Optional twin pin connector

Easily add or remove Nano-Lok legs without removing the connector from the harness



Steel Fast Connection System



Meets or Exceeds Industry Standards
EN 360 : 2002.

3M™ Fall Protection

3M™ DBI-SALA® Nano-Lok™ Web Self-Retracting Lifeline



3101207 3101265 3101208

CE
EN360

	↔	🔗	🔗	📊
3101207	1.95 m	(A)	57 mm	1.31
3101265	1.95 m	(S)	19 mm	1.28
3101208	2 m	(A)	57 mm	1.29

3M™ DBI-SALA® Nano-Lok™ Web Self-Retracting Lifeline



3101298

CE
EN360

	↔	🔗	🔗	📊
3101298	1.95 m	(A)	57 mm	2.47

Nano-Lok Hot Work Web SRL



Best Seller
3101522

CE
EN360

	↔	🔗	🔗	🔗	🔗	📊
3101522	2 m	🔗	(A)	57 mm	1.50	
3101525	2 m	■	(A)	57 mm	3.20	

Nano-Lok XL Web SRL



Best Seller
3101644

CE
EN360

	↔	🔗	🔗	🔗	📊
3101617	3.4 m	🔗	(A)	19 mm	1.20
3101644	2.8 m	🔗	(A)	57 mm	1.50

3M™ Fall Protection

3M™ DBI-SALA® Nano-Lok™ Edge Self-Retracting Lifeline

Nano-Lok Edge is specifically designed for foot level tie-off and sharp edge applications often found in construction. It is ergonomically designed for ease-of-use and is ideal for direct connection to most harnesses. The extremely compact and lightweight design is virtually unnoticeable on your back, staying out of the worker's way and making it ideal as a lanyard replacement. Whether your application requires single or twin leg configurations, mounting to an overhead anchor or for connection directly to harness, there are numerous models to choose from to suit almost any application. Nano-Lok locks quickly - stopping a fall within inches - providing more protection at low heights. In addition, tension is always kept on the lifeline, which reduces dragging, snagging and trip falls. Both features are key safety improvements.



Features and Benefits:

Dedicated Foot Level Tie-Off

- Dedicated design minimises fall forces, auto retraction of unused lifeline minimises trip hazards.

Easy-Fit Connector

- 360° rotation, full integration with energy absorber, frees D-Ring for other equipment.

Impact-Resistant Housing

- Lightweight but extremely durable.

Galvanised Steel 5 mm or Heavy-Duty Web Lifeline

- Extreme sharp edge protection.

Designed to Meet Sharp Edge Standards

- Cable - Galvanised steel 5 mm lifeline - Extreme sharp edge protection - Meets CE EN:2002 & standard requirements of VH11.60 rev 7.
- Web - High-resistance web 20 mm Dyneema® web makes lightweight and extreme resistance performance possible.

Multiple Hook Options

- Configure to your unique requirements.

Integrated Back-Pack Style Energy Absorber

- Works with connector to limit fall forces, for extreme sharp edge performance. Back pack design stays tight, evenly disperses weight.

141 kg Weight Capacity

- Ultimate jobsite flexibility to accommodate users who carry more equipment.

Fall Factor 2 compliant

- Can be connected at foot level.



3M™ Fall Protection

3M™ DBI-SALA® Nano-Lok™ Edge Tested Cable and Web SRL's



3500244



3101443



3101433



3500241

Nano-Lok Edge Tested Cable SRL

Best Seller
3500244

CE
EN360

	Length	Attachment	Connector	Label	Width	Weight
3500244	2.4 m	□	🔗	(A)	57 mm	1.46
3500241	2.4 m	■	🔗	(A)	63.5 mm	2.49

Nano-Lok Edge Tested Web SRL

CE
EN360

	Length	Attachment	Connector	Label	Width	Weight
3101433	2.5 m	□	🔗	(A)	57 mm	1.30
3101443	2.5 m	■	🔗	(A)	57 mm	2.22

3M™ Fall Protection

3M™ DBI-SALA® Sealed-Blok™ Self-Retracting Lifeline

3M™ DBI-SALA® continues to set the standard for quality in fall protection. The Sealed-Blok SRL family has a fully comprehensive line of sealed SRLs and decades of proven field service.

Features and Benefits:

Sealed Design (Patent Pending)

- Ensures efficient, safe operation under all working conditions – meets IP69K sealed rating.

141 kg Weight Capacity

- Higher capacity for operator and tools.

Carrying Handle

- Built-in design for easy transport with improved ergonomics.

Secondary Anchorage Point

- Certified for “dropped objects” Protection Rated for fall arrest if **primary anchor fails**.

Retrieval Winch

3M™ DBI-SALA® Sealed-Blok™ Self Retracting Lifeline - RSQ™

Dual Mode Design

- Allows user to select between fall arrest mode and descent mode.

5 mm Diameter Wire Rope

- Stainless steel for corrosion resistance.

Self-Locking Swivel Hook

- Limits lifeline twisting.

Anti-Ratcheting Design

- Stays locked on rigid and non-rigid (horizontal lifeline) anchors.

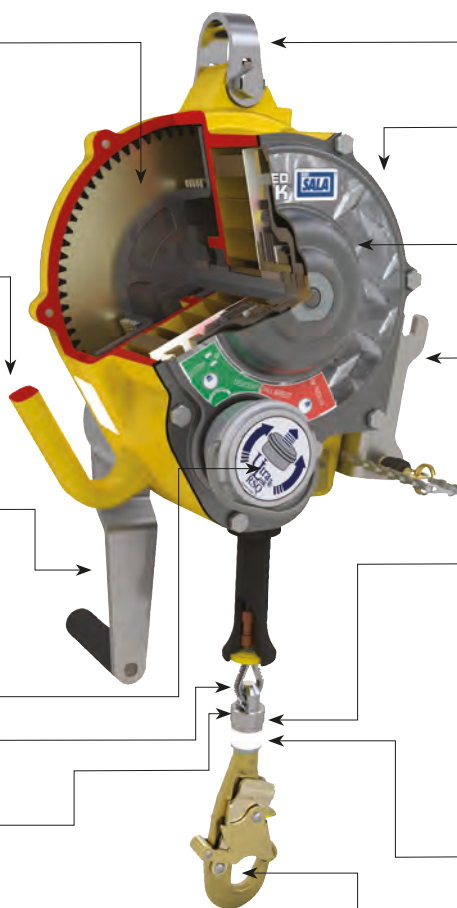

Pivoting Anchorage Loop

- Centres the load.

Aluminium Housing

- Provides exceptional strength, durability and corrosion resistance.

Stainless Steel End-Plate

- Durable construction for harsh environments.

Tripod/Davit Arm Bracket

- No tools required for install.

Ergonomic Cable Handle

- Provides added comfort and ease-of-use when making connections.

Galvanised and Stainless Steel Cable

- Abrasion resistant and corrosion resistant lifeline options.

3M™ DBI-SALA® FAST-Line™

- Provides the user with ability to replace the lifeline in the field. Eliminates the need to service / reset the brake after a fall arrest.

Impact Indicator

- Provides visual indication of Fall Arrest.

1630 kg (3600 lb) Gate

- Reduces chances of accidental disengagement (“roll-out”).

3M™ Fall Protection

3M™ DBI-SALA® Sealed-Blok™ Cable Self-Retracting Lifeline - 4.5 m - 9 m



CE
EN360
EN
1496

(Retrieval models)

	↔	⚙	🔒	⏪	📊
3400805	9 m	SS	SS	■	9.00
3400856	9 m	SS	SS	■	12.00

3M™ DBI-SALA® Sealed-Blok™ Cable Self-Retracting Lifeline - 15 m



CE
EN360

EN
341
CLASS D

(RSQ™ models)

EN
1496

(Retrieval models)

	↔	⚙	🔒	⏪	(RSQ)	📊
3400951	15 m	SS	G	■	■	13.00
3400961	15 m	SS	SS	■	■	13.00
3400956	15 m	SS	SS	■	■	14.90
3400944	15 m	SS	SS	■	■	14.90

3M™ DBI-SALA® Sealed-Blok Cable SRL - 25 m



CE
EN360

EN
341
CLASS D

(RSQ™ models)

EN
1496

(Retrieval models)

	↔	⚙	🔒	⏪	(RSQ)	📊
3400867	25 m	SS	SS	■	■	22.00
3400881	25 m	SS	SS	■	■	23.50

3M™ DBI-SALA® Sealed-Blok Cable SRL - 40 m



CE
EN360

EN
1496

(Retrieval models)

	↔	⚙	🔒	⏪	(RSQ)	📊
3400986	40 m	SS	SS	■	■	30.00
3400971	40 m	G	G	■	■	26.00

3M™ Fall Protection

3M™ DBI-SALA® Ultra-Lok™ Self-Retracting Lifeline

Ultra-Lok web and cable SRLs are rugged, highly engineered devices that can be counted on for user safety, efficiency and reliability. Available with synthetic rope, stainless steel or galvanised steel cable and aluminium or thermoplastic housing. The Ultra-Lok RSQ™ model is an innovative dual-mode SRL for fall arrest and integrated rescue.

Features and Benefits:



Anchor Swivel

- Allows the block to align with lifeline and avoid any torsion of the cable when the user is working.



Lightweight and Durable Thermoplastic Housing

- Provides exceptional durability and is lightweight for easy handling.



Stainless Steel Components

- Stainless steel internal parts ensures increased corrosion resistance and operational longevity.



Semi-sealed Design

- Gasket between the housings makes the block semi-sealed which increases protection against the intrusion of dust and water thereby offering additional protection against corrosion.



Constant Moving Pawls, Anti-ratchet System

- Anti-ratchet system means the pawls do not easily disengage after a fall. This innovative feature ensures that the pawls will remain engaged even if the anchorage structure is flexible and likely to induce rebounds.

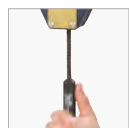

Reserve Lifeline

- Allows the brake to perform even if a fall occurs when the cable is fully extended.

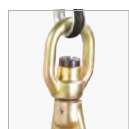

Impact Indicating Hook

- Allows easy visual inspection to determine if the unit has experienced a fall by a user.

141 kg Weight Capacity

- Higher capacity for operator and tools.



RSQ Dual Mode Design



Fall Arrest - Assisted Rescue by Hand



Fall Arrest - Assisted Rescue by Pole

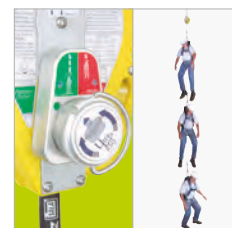

Automatic Descent Mode

3M™ Fall Protection

3M™ DBI-SALA® Ultra-Lok™ Cable SRL - 6 m



CE
EN360

	↔	🔗	🔒	🌀	🏋️
3504427	6 m	Ⓞ	Ⓢ	18 mm	4.50
3504429	6 m	ⓈⓈ	ⓈⓈ	18 mm	4.50

3M™ DBI-SALA® Ultra-Lok Cable SRL - 9 m



CE
EN360

	↔	🔗	🔒	🌀	🏋️
3504424	9 m	Ⓞ	Ⓢ	18 mm	5.40
3504426	9 m	ⓈⓈ	ⓈⓈ	18 mm	5.40

3M™ DBI-SALA® Ultra-Lok Cable SRL - 15 m



	↔	🔗	🔒	🌀	🏋️
3504467	15 m	ⓈⓈ	ⓈⓈ	18 mm	7.45

3M™ DBI-SALA® Ultra-Lok Cable RSQ™ SRL - 15 m



RSQ
EN
341
CLASS D

	↔	🔗	🔒	🌀	🏋️
3504553	15 m	Ⓞ	Ⓢ	18 mm	8.50
3504554	15 m	ⓈⓈ	Ⓢ	18 mm	8.50
3504555	15 m	ⓈⓈ	ⓈⓈ	18 mm	8.50

3M™ Fall Protection

3M™ Protecta® Rebel™ Cable Self-Retracting Lifeline

Total compliance, absolute confidence. Rebel cable SRLs are available with a heavy duty aluminium or a durable lightweight thermoplastic housing, providing an economical fall protection solution without compromising on performance or safety. Integrated ergonomic carrying handle and top swivel connector ensure easy transport and installation. Built-in fall indicator hook allows visual yearly inspection. Rebel Cable blocks meets the latest CE sharp edge certification when used with an extension sling or when using a specific sharp edge model.

Features and Benefits:

Anchor Swivel

- Allows the block to align with lifeline and avoid any torsion of the cable when the user is working.

Choice of Housing (Thermoplastic or Aluminium)

- Durable thermoplastic for lightweight or aluminium for ultimate ruggedised housing allows for job site flexibility.

Galvanized or Stainless Steel 5 mm Cable

- Larger cable diameter for added strength and safety.

Side Cable Exit

- Allows best alignment of the cable and minimises cable guide wear.

Ergonomic Cable Bumper

- Allows the block to align with lifeline and avoid any torsion of the cable when the user is working.

Ergonomic Carrying Handle

- Allows easier transportation of the block.

140 kg Weight Capacity

- High capacity allows for use by most users and tools ensuring the highest level of safety.

Swivel Hook with Fall Indicator

- Allows easy visual indication if a fall has occurred



3M™ Fall Protection

3M™ Protecta® Rebel™ Cable Self-Retracting Lifelines - 6-30m



Best Seller
3590520
3590570

CE
EN360



Best Seller
3590610

CE
EN360

	Length	Shock Absorber	Energy Absorber	Anchor	Weight
3590520	6 m	⚙️	Ⓣ	Ⓜ	5.30
3590521	10 m	⚙️	Ⓣ	Ⓜ	5.60
3590522	10 m	⚙️	Ⓣ	ⓈⓈ	5.60
3590570	15 m	⚙️	Ⓣ	Ⓜ	7.50

	Length	Shock Absorber	Energy Absorber	Anchor	Weight
3590610	20 m	⚙️	Ⓣ	Ⓜ	10.00
3590650	25 m	⚙️	Ⓣ	Ⓜ	13.00
3590651	25 m	⚙️	Ⓣ	ⓈⓈ	13.00
3590690	30 m	⚙️	Ⓣ	Ⓜ	13.40

3M™ Protecta® Rebel™ Cable Leading Edge Self-Retracting Lifelines

Complies to extreme sharp edge (VG11.054, type B, 0 mm radius). Users are able to tie-off at foot level with the Rebel 6m Leading Edge SRL without requiring to connect the sharp edge extension sling. This built-in sharp edge product was put through extensive sharp edge testing to ensure protection against sharp, abrasive and leading edges found at construction sites.



Best Seller
3590545

CE
EN360

	Length	Shock Absorber	Energy Absorber	Anchor	Weight		
3590542	6 m	Ⓜ	5.6 mm	⚙️	Ⓣ	Ⓢ	5.60
3590545	12 m	Ⓜ	5.6 mm	⚙️	Ⓣ	Ⓢ	8.50

3M™ Protecta® Rebel™ Cable Retrieval Self-Retracting Lifelines

These Retrieval models incorporate fall arrest and a built-in emergency retrieval winch for rescue, making them a versatile solution for many job sites.

- 15m SRL with rescue winch
 - Brackets available for easy tripod integration
 - Designed for confined space applications
- 3590498 - Bracket for AM100 Protecta tripod
3590499 - Bracket for DBI-SALA® tripods KM1PT7 and KM1PT9 and DBI-SALA® Davit HC



Best Seller
3591002

CE
EN360
EN
1496

	Length	Shock Absorber	Energy Absorber	Anchor	Weight		
3591002	15 m	Ⓜ	5 mm	⚙️	Ⓜ	Ⓢ	11.90
3591003	15 m	ⓈⓈ	5 mm	⚙️	Ⓜ	Ⓢ	11.90

3M™ Fall Protection

3M™ Protecta® Rebel™ Web Self-Retracting Lifeline

Rebel Web SRL's are housed in super-tough thermoplastic making them lightweight, compact, durable and UV resistant. High strength polyester webbing provides added durability and longevity. For additional versatility they are available in a variety of lengths and connector options.

Best Seller
3100423

CE
EN360

	←→	🔗	📏	👤	👤	👤	📏
3100420	2 m		19 mm	🔗	Ⓣ	Ⓩ	1.20
3100421	2 m		57 mm	🔗	Ⓣ	Ⓐ	1.40
3100422	2.1 m	■	57 mm	🔗	Ⓣ	Ⓐ	2.60
3100423	3 m		19 mm	🔗	Ⓣ	Ⓩ	1.40
3100437	6 m		19 mm	🔗	Ⓣ	Ⓩ	2.20



3M™ DBI-SALA® Load Arrestor

Best Seller
KD4PLA5005

	←→	🔗	👤	📏	Working Load	📏
KD4PLA3012	12 m	Ⓞ	Ⓐ	5 mm	300 kg	8.70
KD4PLA5005	5 m	Ⓞ	Ⓐ	7 mm	500 kg	8.30



Not suitable for personal fall arrest. Load arrestors are safety devices used in conjunction with lifting devices such as cranes and hoists. The Load arrestor provides independent protection that will arrest the fall of a load in the event of the primary system failing and reduces the risk of equipment damage and protects personnel in and around the danger zone. Models available to protect loads from 100 kg to 3,000 kg.



Confined Space Solutions

3M™ DBI-SALA® Davit Arm

3M™ DBI-SALA® Davit Arm Systems are designed for manhole and confined space entry/retrieval applications.

These units are constructed of lightweight materials including high-strength aluminium. The davit pivots for ease-of-rescue and has adjustment for overhead clearance restrictions.

The lower base adjusts to fit most standard entries. Many other portable and fixed bases are available to suit any jobsite need.

A Fall Arrest Anchorage

Davits offers 4 x EN 795 type B anchor points and are **certified for fall arrest for 2 users at the same time**

- 2 anchor points for direct connection with fall arrest PPE
- 2 guided cable lifelines from a 3M™ mounted SRL.

B One Front and One Back Cable Lifeline Guide

In addition to being a fall arrest anchorage, the 2 guided cable lifelines serve as:

- Rescue line with a mounted 3M™ DBI-SALA® rescue winch or 3M™ SRL with built-in rescue winch
- Raising / lowering line for people or load with a mounted 3M™ DBI-SALA® man and load-riding digital winch.

C Winch and SRL Options

Winch and SRL can be mounted on the mast with appropriate bracket.

Front or back mounting choice is possible to allow the most convenient positioning for the user, unlike some others systems that only allow the winch and SRL to be back mounted or allowing only one fixation to the mast.

Adjustable Reach and Height

D Selection of one of the 4 davit mast extension options allows the user to select the best height setting for the operating environment.

E Multiple pins position of the gusset arm and head allows the user to adjust the best reach and height needed for the application.

Possibility of maximum height of anchorage point is 2.91 m, allowing use over most tanks edges and guardrails.

F Base Options

Fixed bases in galvanized steel or stainless steel are available to accommodate a variety of anchorage locations. One short reach and one long reach portable 3 piece base options allow full versatility of the systems.

Maximum external width of long reach 3 piece base is 2.61 m, allowing the surround of very large confined space openings.

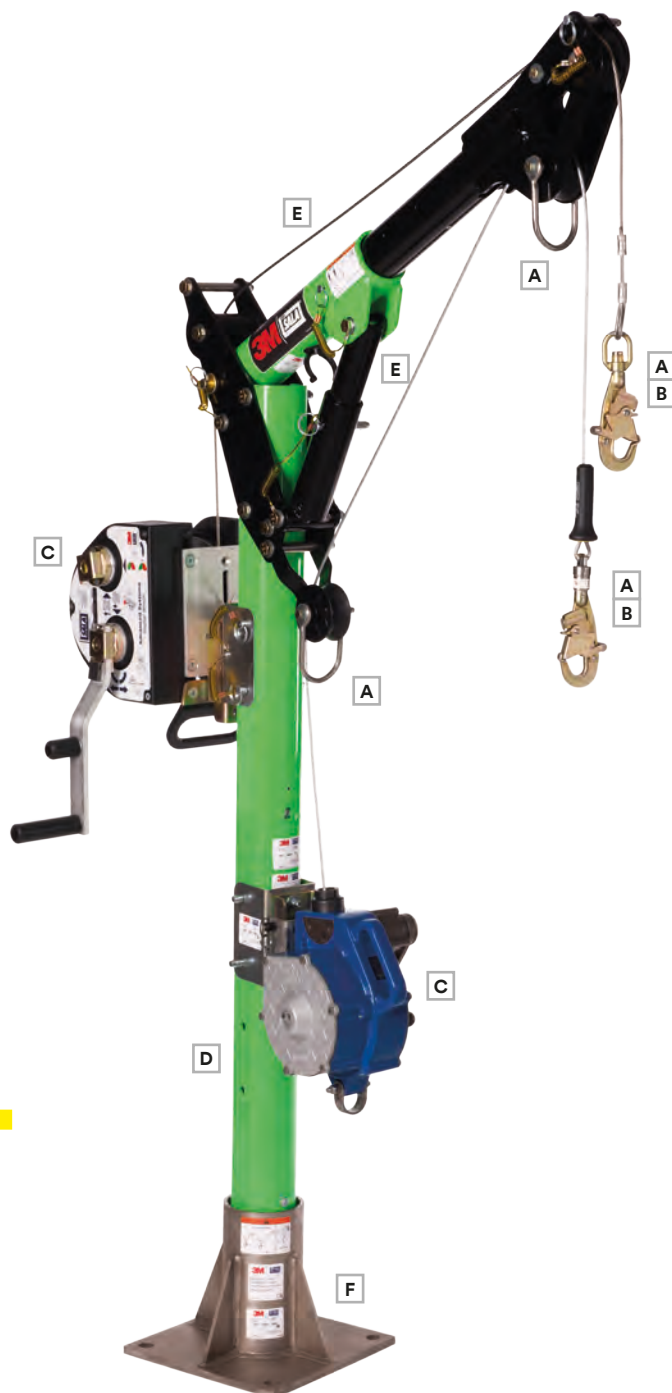

3M™ DBI-SALA® 5 Piece Short Reach Davit High Capacity (HC)



8000118 S 65.30

Includes Short Reach Davit Arm High Capacity (8000107), 84 cm Mast Extension (8000113) and Short Reach 3 Piece Davit High Capacity Base (8000104). Includes 1 winch mounting bracket.

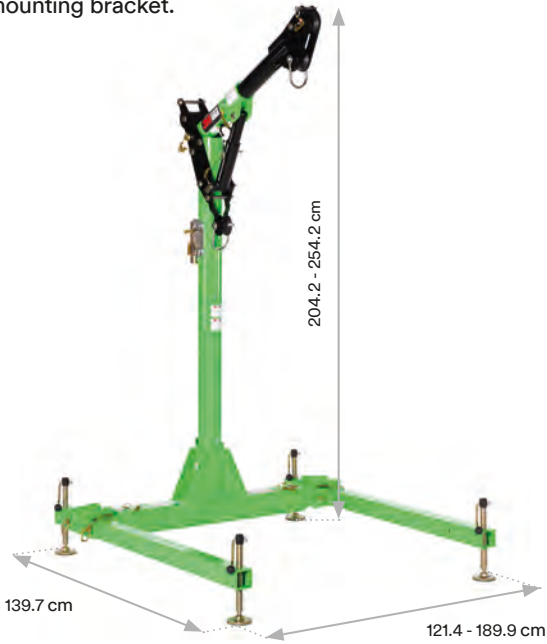

3M™ DBI-SALA® 5 Piece Short Reach Davit High Capacity (HC)



8000119 L 81.60

Includes Long Reach Davit Arm High Capacity (8000108), 84 cm Mast Extension (8000113) and Long Reach 3 Piece Davit High Capacity Base (8000105). Includes one winch mounting bracket.

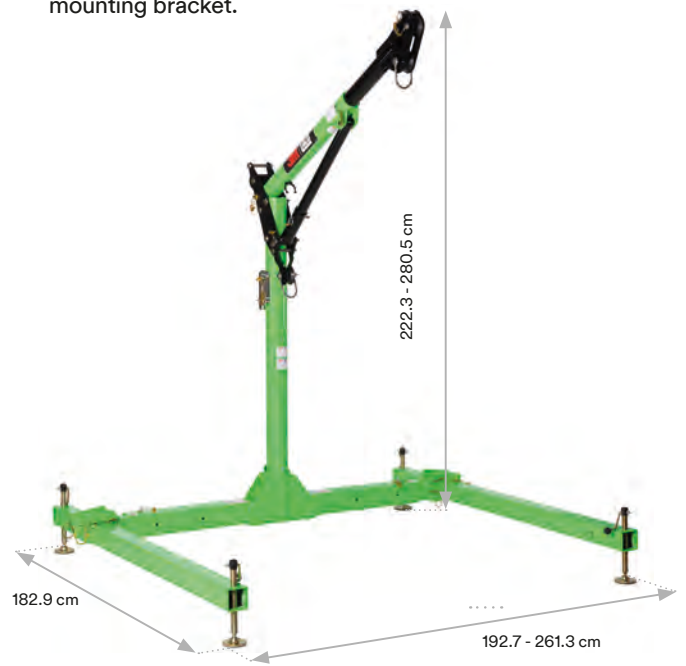

3M™ DBI-SALA® Floor Mount Base High Capacity

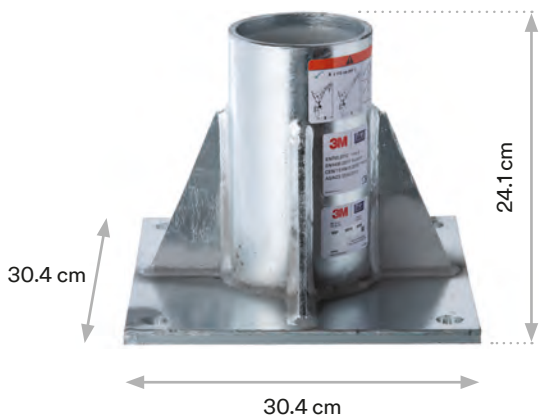

3M™ DBI-SALA® Wall Mount Base High Capacity



Description		
8000095	Galvanised steel	15.60
8000096	Stainless steel - 304	15.60

Mounts to horizontal concrete or steel structure. Comes with PVC sleeve liner.

Description		
8000101	Galvanised steel	15.70
8000102	Stainless steel - 304	15.70

Compact design creates minimum intrusion into work space. Mounts to vertical concrete or steel structures. Comes with PVC sleeve liner.

Hooks and Carabiners

Twist Lock Self-Locking Carabiner

The automatic gate closing and locking makes it an ideal choice when the user will open and close the connector many times during the work period. Quick and easy to open with one hand.



CE
EN362

AJ514	18 mm	(S)	25 kN	0.18
KJ5024	21 mm	(A)	25 kN	0.48
KJ5106	33 mm	(S)	45 kN	0.55
AJ593	50 mm	(S)	25 kN	0.71
2000112	17 mm	(S)	22 kN	0.23
2000127	18 mm	(SS)	22 kN	0.32

Screw Gate Carabiners

The screw gate is ideal in working situations where opening is occasional during the working day, as the gate can be opened by the action of pushing it onto the anchorage point. The gate can then be manually locked once the carabiner holds the weight of the device.



CE
EN362

AJ520	17 mm	(A)	25 kN	0.09
AJ501	17 mm	(S)	25 kN	0.17
KJ5107	25 mm	(S)	50 kN	0.22

Triple Twist Lock Self-Locking Carabiner

Triple lock provides the user with confidence that the gate will not accidentally unlock.



CE
EN362

KL216SS	21 mm	(A)	30 kN	0.22
AJ572	24 mm	(A)	22 kN	0.11

3M™ Protecta® Manucroche Anchor Clamp

An anchor clamp in stainless steel wire, the Manucroche is the ideal connector for anchoring a fall arrest system to a steel structure. The double locking automatic closure system guarantees a connection that will withstand any challenge.



CE
EN362

AJ302	110 mm	(SS)	24.5 kN	0.35

Scaffold and Snap Hooks

This detachable scaffold hook can be attached to spliced or webbing lanyards, and other PPE products. Detachable with internal gate means it can be added to a range of products and stays there until it is decided to be removed.



CE
EN362

KJ5108	50 mm	(S)	30 kN	0.70

Fall Protection for Tools

Protecting workers takes more than just keeping them from falling. Their equipment also needs to be kept safe at height. That's why for over 10 years, we've been pioneering an innovative line of products and solutions to prevent dropped tools and equipment. From construction sites to oil rigs, we help make work environments safer and more productive by protecting workers from hazards that can result in personal injury, equipment damage and tool loss. Tested and adapted for all applications. Our onsite ISO 17025 accredited lab allows us to simulate heat, cold, moisture, corrosion and abrasion—the challenges you face every day. We conduct dynamic and static strength tests, both in the field and in our ISO 90001 certified manufacturing facilities, ensuring you get the highest quality, most reliable fall protection for tools.



3M™ Fall Protection

3M™ DBI-SALA® Adjustable Radio Holster

- Holster adjusts to fit virtually any hand-held radio, mobile phone, and many other devices.
- Can be worn from belt or harness.
- A Micro D-ring can be placed on the back of a device, and can then be tethered to a D-ring on the front of the Adjustable Radio Holster using a 1500066 Clip2Loop Coil Tether.



3M™ DBI-SALA® Hook2Hook Coil Tethers



Description	
1500089	Adjustable Radio Holster, Clip2Loop Coil Tether and Micro D-ring

Description	📦	⚖️ (kg)	↔️ (relaxed)	↔️ (stretched)
1500160 Hook2Hook Coil Tether	10	2.3 kg (5 lbs)	10.2 cm (4")	157.5 cm (62")
1500060 Clip2Clip Coil Tether	10	2.3 kg (5 lbs)	17.8 cm (7")	86.4 cm (34")

3M™ DBI-SALA® Small Parts Pouches

- Innovative self-closure system traps objects inside, making it nearly impossible for objects to fall out once placed in the bag
- Easy to retrieve objects since no opening or closing is necessary
- Compatible with most tool belts



3M™ DBI-SALA® Hook2Loop Bungee Tether

- Simply slides onto the handle of a tool in seconds.
- Swivel spin top makes them tangle resistant.
- Reusable and suitable for non-conductive use.



Description	
1500119	Small Parts Pouch, canvas black
1500120	Small Parts Pouch, canvas camo
1500121	Small Parts Pouch, canvas orange
1500122	Small Parts Pouch, vynal yellow

Description	📦	⚖️ (kg)	↔️ (relaxed)	↔️ (stretched)
1500048 Hook2Loop Bungee Tether	10	6.8 kg (15 lbs)	81.3 cm (32")	119.4 cm (47")
1500049 Medium-Duty Hook2Loop Bungee Tether		15.9 kg (35lbs)	78.7 cm (31")	132.1 cm (52")

3M™ Fall Protection

Fall Protection for Tools

3M™ DBI-SALA® Quick-Wrap Tape II

- Heavy duty 2.54 cm (1") wide tape with high-elongation properties resulting in more wraps with the same length of tape
- Use with our D-rings and Tool Cinch Attachments to create instant tethering points on virtually any tool.
- Conforms to shape of tool handles, adheres on contact to most clean tools and can be repositioned during installation.
- Proprietary 3M material and adhesive provide good tear resistance.
- 3 Year shelf life



	Description		
1500175	Quick-Wrap II, yellow	10	274 cm (108")
1500169	Quick-Wrap II, blue	10	274 cm (108")

3M™ DBI-SALA® Adjustable Wristbands

Our adjustable wristband uses a hook and loop system to adjust to any wrist size. An elastic band helps ensure a comfortable fit.



	Description	
1500083	Adjustable Wristband	10
1500085	Adjustable Wristband with Cord	10

3M™ DBI-SALA® Safe Buckets

With an integrated closure system that helps prevent dropped objects, our Safe Buckets are designed to be the ideal companion for workers at height carrying heavy loads.



		Closure system		Height/diameter	Capacity
1500134	45.4 kg (100lbs)	Hook and loop	Canvas	38 cm / 31.75 cm (15" / 12.5")	30 L
1500140					

3M™ DBI-SALA® Single and Dual Tool Holsters

- Single and Dual Tool Holsters are equipped with D-rings that are load rated for 2.3 kg (5 lbs).
- Several variants of these holsters come with Retractors (indicated below). Retractors are load rated for 0.7 kg (1.5 lbs).
- Single and dual tool holsters feature Beacon High-Visibility Reflectors and the Quick-Mag Magnetic Tool Staging System.
- A bottom drain vent allows the holster to perform even in wet conditions.



[1] Hook2Loop Bungee Tether sold separately.

	Description	Retractors included	Attachment
1500107	Dual Tool Holster with Retractors	2x	Belt
1500109	Dual Tool Holster with Retractors	2x	Harness

3M™ Fall Protection

Anchorage

3M™ Protecta® Fixed Anchorage Plate

12 mm fixing, 3 mm thick.



CE
EN795
CLASS B



AM210

0.04

3M™ Protecta® Fixed D-ring Anchorage

12 mm fixing. Can be used in 3 load directions.



CE
EN795
CLASS A



AM211

0.13

3M™ Protecta® Nylon Webbing Sling

Four safety seams.



2
CE
EN795
CLASS B

CE
EN795
CLASS B



AM450/80

25 mm x 80 cm

0.07

AM450/150

25 mm x 150 cm

0.25

3M™ Protecta® Galvanised Steel Sling

Thimble ends and PVC protective sleeve.



1
CE
EN795
CLASS B

CE
EN795
CLASS B



AM401G

1 m

6 mm

0.29

AM402G

2 m

6 mm

0.47

3M™ Fall Protection

Anchorage

3M™ DBI-SALA® Fixed Beam Anchor

Installs in seconds to the beam structure in any orientation, with final tightening using a built-in adjustment handle.



Anchor beam dimensions chart

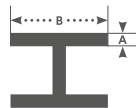

	A	B	kg
2108412	3.81 cm	6.35 - 30.48 cm	2.40
2108413	3.81 cm	6.35 - 45.72 cm	2.70
2108414	3.81 cm	6.35 - 60.92 cm	3.00

3M™ DBI-SALA® Freestanding Rooftop Counterweight Anchor

The rooftop freestanding counterweight anchor does not require attachment to a working surface and provides a safe and versatile fall arrest rated tie-off point.



	Description	kg
2100180	Counterweight anchor	327.00

3M™ DBI-SALA® Glyder™ 2 Sliding Beam Anchor

Provides complete horizontal mobility on i-Beams, attach overhead or at your feet (use with 3M™ DBI-SALA® Force2™ Shock Absorbing Lanyard when used at your feet). 'Wear pads' eliminate metal-to-metal contact, for smooth operation. Integrated ratcheting adjustment system for easy installation. Dual beam grip adjustment prevents twisting and turning. User capacity: 141 kg.



2104700	2.05
---------	------

3M™ DBI-SALA® Saflok™ Concrete Wedge Anchor

Quick-release button for fast removal with a pivoting easy-grip handle. Innovative forged connection ring provides a compatible tie-off point. Shielded load cable and chock release cables.



2100100	0.30
---------	------

3M™ DBI-SALA® Concrete D-ring Anchor

Reusable D-Ring assembly. Rugged design for harsh environments. Safe 'hook-up' indicator notifies user of proper installation. Install into 18 mm or 19 mm holes - only standard drill bits needed.



2104565	1	0.50
---------	---	------

3M™ Fall Protection

3M™ DBI-SALA® Polyester Webbing Sling

Sling Polyester Webbing and stainless steel links. Choke back facility on KM419 & KM421.



	W \longleftrightarrow	H \longleftrightarrow	kg
KM419	45 mm	90 cm	0.47
KM421	45 mm	200 cm	0.86

3M™ DBI-SALA® I-Beam Trolley Anchor - Adjustable

The trolley is for use with self retracting lifelines on horizontal beams and has been engineered for ease-of-use and superior performance. Glides effortlessly along the beam and provides horizontal mobility. Attachable anywhere along beam, including midpoint. Non-corrosive double-shielded wheel bearings are maintenance free. Trolley Guards protect the wheels from damage and keep beam clear of debris.



Note: SRL not included



	kg
2103148	6.80

3M™ DBI-SALA® EZ-Line™ Temporary Horizontal Lifeline

EZ-Line is a temporary horizontal lifeline system that is user friendly and extremely fast to install. The innovative retractable design of EZ-Line eliminates large and bulky coils of cable that are difficult to set-up, relocate and store. Built-in winch for fast and easy set-up, use and dismantling. Customise length in any increment up to 18.25 m. Built-in pre-tension and impact indicators for easy set-up and inspection. Extremely lightweight, 33% lighter than conventional systems.

Applications



	\longleftrightarrow	kg
7605061	18.25 m	14.96

3M™ Fall Protection

3M™ DBI-SALA® Rollgliss™ Rescue Systems

When the clock starts ticking, you need a rescue plan you can count on to rescue you quickly and efficiently. The type of job site, anchor location, working load and limit, and ease of use are some important considerations when choosing the appropriate rescue and descent system. A single rescue system cannot efficiently handle every scenario, performing well for one application but not another. Some rescue systems are easy to use for one application, while others require more skill but can be adapted for use in multiple situations.

Applications

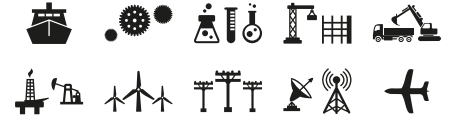

3M™ DBI-SALA® Rollgliss™ R550 Rescue System with rescue hub

Emergency Escape

Use the Rollgliss 550 as an escape device when it is imperative to get to the ground as quickly as possible.

Assisted Rescue Pick-Off

Use the Rollgliss 550 for an assisted pick-off rescue when a victim is unable to get to safety alone. Lower to the victim and hook up to them and use the device to descend to safety.

Assisted Rescue

Attach the Rollgliss 550 to the top of the wind turbine and lower the hook end to the victim and lower them to the ground.

Custom Rescue

The Rollgliss 550 can be used in many custom rescue situations. Use the system to repel down the structure to safety.

Features and Benefits:

Optional Rescue Hub

- Allows to perform not only evacuation but also rescue.

Bi-Directional Hub

- Rope descends from either side which brings one hook up as the other goes down, allowing for immediate use after each descent.

Optional Bracket

- Allows quick and easy connection to the ladder rung in order to optimise effectiveness of the rescue.

Durable Rope

- 9.5 mm (3/8") static kernmantle rope rated for durability.

Multiple Length Options

- Lengths from 10 to 200 m for 2 persons and from 10 to 500 m for 1 person.

Weight Capacity

- 282 kg.

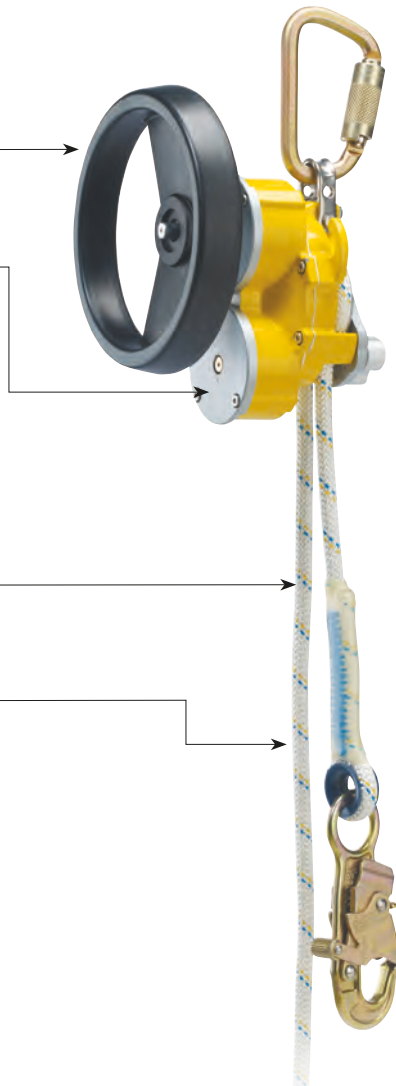

CE
EN341

EN
1496

	←····→	kg
3329030	30 m	4.59
3329050	50 m	5.73

Other lengths or longer lengths up to 500 m contact us.

3M™ Fall Protection

3M™ DBI-SALA® Rollgliss™ R350 Rescue System

The Rollgliss R350 system provides efficient hauling, but more importantly, very controlled lowering (a finger and thumb are all that is required to hold a load). This system also allows you to change the hauling ratios on the fly with quick release pulleys, allowing custom rigging for different applications and jobsites.

- Interchangeable pulley system with a 3:1 ratio standard
- Includes everything you'll need for efficient rescue
- Rope retention bar does not allow rope to twist or overlap
- Visual and audible function controls
- Static kernmantle rope for optimum performance
- Quick connect system allows fast insertion of various pulleys
- Weight capacity 150 kg



CE
EN341
EN
1496

3M™ DBI-SALA® Rollgliss™ R250 Rescue Kit

Kit includes: R250 automatic blocking descender and belay device, rope (10 m, 20 m, or 30 m travelling lengths), 5 m telescopic rod, rigging system, ascent handle, anchorage ring and carrying bag. Weight capacity 150 kg.



	←→	Ratio	Person	kg
AG6350ST31/30	7.5 m	3:1	1	5.70
AG6350ST31/60	15 m	3:1	1	6.20
AG6350ST51/60	10 m	5:1	2	6.40

	←→	kg
AG62501010	10 m	6.10
AG62501020	20 m	6.60
AG62501030	30 m	7.10

3M™ Protecta® Aluminium Tripod

For tasks in a confined space, a reliable anchorage point must be used to allow work to be carried out effectively and in complete safety. This aluminium mobile tripod can be easily transported and deployed. Four independent anchorage points mean that a rig for suspended work can be used in combination with a self-retracting fall arrest device that incorporates a retrieval system, fall arrest and rescue equipment. 8 adjustable positions. Usage height 1.35 m to 2.35 m. Base dia. 1.50 m to 2.56 m.



CE
EN795
CLASS B

	kg
AM100	19.00

3M™ Protecta® Steel Guide Pulley

Complete pulley with AJ501 Carabiner.



	kg
AT052/1	0.91

Rescue Winch

Designed for rescue purposes in confined spaces. The integrated fixing plate means it can be easily mounted on the AM100 mobile tripod. Its reduction ratio of 4.1/1 means a victim can be rapidly retrieved. N.B. A rescue winch should always be used together with a fall arrest system.



CE
EN1496
CLASS B

	⚙️	∅	←→	kg
AT200/I20	5 mm	5 mm	20 m	10.10

3M™ DBI-SALA® Flexiguard EMU System

The latest from the FlexiGuard™ Solutions product line is the highly customizable, CE compliant, Engineered Modular Unit System (EMU™). This modular system is designed for easy adjustment and maximizing flexibility without sacrificing safety. The lightweight design allows for easy mobility around the jobsite with a forklift truck (3.1 ton).

With three adjustable height models plus three mounting options, there is a configuration to fit virtually any need. The 360° rotation mast allows for a 1.8 m (6 ft.) working radius from the anchor point. These systems are CE compliant.



EMU™ Systems

- Rotation handle included for turning system into working position
- Installed Glide 360 Rail with trolley
- Rotational locking pin includes adjustments at every 11 degrees



Adjustable Height EMU Systems

	Anchor Height	Offset	Concrete	# of Users
8560018	3.05 m - 4.57 m (10' - 15')	2.1 m (7')	N/A	1
8560017	3.96 m - 6.10 m (13' - 20')	2.1 m (7')	N/A	1
8560014	4.57 m - 7.62 m (15' - 25')	2.1 m (7')	N/A	1

Note: fixed base of EMU System (8560026 and 8560023) are compatible with SafRig™ System boom (8545755).

Base Configurations

	Base Type	Concrete	Anchorage Material
8560026	Concrete Floor Mount	N/A	Concrete, Steel
8560023	Top Floor Mount	N/A	Concrete
8560013	Counterweight	Without	Solid, Level Surface
8530563	Jack Levelling Kit	N/A	N/A



3M™ Protecta® Cabloc™ Vertical Lifeline System

The 3M™ Protecta® Cabloc Vertical Cable System offers fall protection for workers whilst providing a functional and practical means of access and egress on structures such as wind turbines and communication towers.

It can be permanently installed to a ladder or other vertical structure. Components are available in either stainless or galvanised steel options.

Features and benefits

Easy and quick to install

- * Top and bottom anchors available in either galvanised or stainless steel
- * Can be installed on structures that incline up to 15 degrees, making it suitable for a variety of structures
- * Components are made from corrosion-resistant finishes making the system suitable for installation in a wide range of aggressive environments
- * Users can attach and detach at any point along the length of the system allowing easy access to platforms and adjacent work areas
- * Traveller automatically follows the user and locks in the event of a fall, providing uninterrupted movement for the user during ascent and descent whilst maintaining complete safety
- * The Cabloc system, used in conjunction with the new Cabloc traveller, is CE marked and tested and conforms with EN353-1:2014. This provides the end user with complete confidence that the system meets the latest standards and legislation

Applications:

- 3M™ Protecta® Cabloc Vertical Cable Safety Systems are suitable for use in a number of applications including:
- * Ladder access
 - * Mast and pylon access including lattice construction towers and monopoles
 - * Wind turbine access
 - * Lighting column access

For more information
contact customer services
on +33(0)4 83 58 08 08
or visit www.3M.com/fallprotection



For more information
contact customer services
on +33(0)4 83 58 08 08 or visit:
www.3M.com/fallprotection

3M™ DBI-SALA® Lad-Saf™ Vertical Lifeline System

Adding or upgrading your vertical safety systems just got easier. The new generation of Lad-Saf™ Systems are re-engineered to simplify and speed up the installation process. With up to 72% fewer loose components* than some of our previous models, these lightweight systems are streamlined for easy installation and maintenance on a variety of structures - such as fixed ladders and telecommunication towers.

They have also been designed to meet the requirements of EN 353-1:2014 and the new ANSI Z359.16 standard when used with our Lad-Saf X2 or X3 sleeve, helping you to stay in compliance with the current fall protection standards.

*On specific models

3M Belgium BVBA / SPRL
Hermeslaan 7
1831 Diegem
België / Belgique
E-mail: 3Msafety.be@mmm.com
www.3Msafety.be

3M Danmark
Hannemanns Allé 53
2300 København S
Danmark
E-mail: 3Msikkerhed@mmm.com
www.3Msikkerhed.dk

3M Deutschland GmbH
Carl-Schurz-Straße 1
D - 41453 Neuss
Deutschland
E-mail: arbeitsschutz.de@mmm.com
www.3Marbeitsschutz.de

3M España, S.A.
Juan Ignacio Luca de Tena, 19-25
28027 Madrid
España
E-mail: ohes.es@3M.com
www.3M.com/es/seguridad

3M France
Boulevard de l'Oise
95006 Cergy Pontoise Cedex
France
www.3M.com/fr/securite

3M Greece
3M Ελλάς Μ.Ε.Π.Ε.
Κηφισίας 20
15125, Μαρούσι
Ελλάς
www.3M.com/gr/occsafety

3M Ireland Limited
The Iveagh Building
The Park, Carrickmines
Dublin 18
Ireland
E-mail: ohes.helpline.uk@mmm.com
www.3M.co.uk/safety

3M Italia srl
Via Norberto Bobbio, 21
20096 Pioltello MI
Italia
E-mail: 3Msicurezza@mmm.com
www.3Msicurezza.it

3M Nederland B.V.
Molengraaffsingel 29
2629 JD Delft
Nederland
E-mail: 3Msafety.nl@mmm.com
www.3Msafety.nl

3M Norge A/S
Postboks 100, 2026 Skjetten
Norge
E-mail: kundeservice@mmm.com
www.3M.no/vern

3M Österreich GmbH
Kranichberggasse 4
1120 Wien
Österreich
www.3M.com/at/arbeitsschutz

3M Portugal
Rua do Conde Redondo, 98
1169-009 Lisboa
Portugal
www.3M.com/pt/segurança

3M Suisse S.a r.l. / Schweiz GmbH
Eggstrasse 93
8803 Rüschiikon
Suisse / Schweiz
www.3M.com/ch/safety

Suomen 3M Oy
Keilaranta 6
02150 Espoo
Suomi
www.3M.fi/suojaimet

3M Svenska AB
191 89 Sollentuna
Sverige
E-mail: kundservice@mmm.com
www.3M.se/personskydd

3M United Kingdom PLC
3M Centre
Cain Road
Bracknell
RG12 8HT
United Kingdom
E-mail: ohes.helpline.uk@mmm.com
www.3M.co.uk/safety

3M Personal Safety Division

EMEA Region
3M Centre, Cain Road
Bracknell, Berkshire, RG12 8HT
United Kingdom
Office: +44 (0)1344 858000
www.3M.eu/PPEsafety

Please recycle. Printed in the UK. © 3M 2019. 3M and Adflo, Aircare, Airstream, Alert, Aura, Cabloc, Caboflex, Classic, ClearEAR, Cool Flow, DBI-SALA, Delta, Duo-Lok, E-A-R, EARcaps, E-A-Rfit, EARsoft, Express, EZ-Line, EZ-Stop, Fahrenheit, FAST-Line, Fuel, Glyder, GoggleGear, Jupiter, Lad-Saf, Maxim, Nano-Lok, NEX, No-Tangle, One-Touch, Optime, PELTOR, Powerflow, Pro, ProTac, Protecta, Push-Ins, Rebel, Repel, Revolver, Rollgliss, RSQ, Sanchoc, Saflok, Scotchgard, Scotchlite, Sealed-Blok, SecureFit, Solar, Solus, Speedglas, Superfit, Surefit, TechLite, Tora, Torque, Tracers, Tri-Flange, Versaflo, Ultra-Lok, Ultrafit, Uvicator, VFlex, Viper, Virtua, WorkTunes, WS and Yellow Neons are trademarks of 3M Company. Bluetooth is a registered trademark of Bluetooth sig, Inc. All rights reserved. J466526

